

# Katana 50 ARF

*Assembly Manual*



## Notice

All instructions, warranties and other collateral documents are subject to change at the sole discretion of Horizon Hobby, Inc. For up-to-date product literature, visit <http://www.horizonhobby.com> and click on the support tab for this product.

## Meaning of Special Language

The following terms are used throughout the product literature to indicate various levels of potential harm when operating this product:

**NOTICE:** Procedures, which if not properly followed, create a possibility of physical property damage AND a little or no possibility of injury.

**CAUTION:** Procedures, which if not properly followed, create the probability of physical property damage AND a possibility of serious injury.

**WARNING:** Procedures, which if not properly followed, create the probability of property damage, collateral damage, and serious injury OR create a high probability of superficial injury.



**WARNING:** Read the ENTIRE instruction manual to become familiar with the features of the product before operating. Failure to operate the product correctly can result in damage to the product, personal property and cause serious injury.

This is a sophisticated hobby product and NOT a toy. It must be operated with caution and common sense and requires some basic mechanical ability. Failure to operate this Product in a safe and responsible manner could result in injury or damage to the product or other property. This product is not intended for use by children without direct adult supervision. Do not attempt disassembly, use with incompatible components or augment product in any way without the approval of Horizon Hobby, Inc. This manual contains instructions for safety, operation and maintenance. It is essential to read and follow all the instructions and warnings in the manual, prior to assembly, setup or use, in order to operate correctly and avoid damage or serious injury.

## Table of Contents

Notice.....	2
Meaning of Special Language.....	2
Introduction.....	2
Product Support.....	2
Specifications.....	2
Included Parts Listing.....	3
Contents of Kit and Parts Listing.....	4
Safety Precautions and Warnings.....	4
Important Information Regarding Warranty.....	5
Using the Manual.....	5
UltraCote Covering Colors.....	5
Recommended Power Setups.....	5
Transmitter Requirements.....	5
Radio Equipment Requirements.....	5
Optional Equipment.....	5
Field Equipment Required.....	6
Optional Field Equipment.....	6
Required Adhesives.....	6
Required Tools.....	6
Before Starting Assembly.....	6
Selecting the Correct Propeller.....	6
Binding the Radio System.....	6
Wing Root Extension Installation.....	7
Aileron Hinging.....	8
Aileron Servo Installation.....	9
Rudder and Tail Wheel Installation.....	11
Main Landing Gear Installation.....	14
Radio Installation.....	15
Rudder Cable Installation.....	18
Elevator and Stabilizer Installation.....	20
Electric Motor Installation.....	23
Glow Engine Installation.....	25
Fuel Tank Assembly and Installation.....	28
Cowl, Propeller and Spinner Installation.....	30
Optional Side Force Generator and Pilot Installation.....	33
Decal Installation.....	34
Center of Gravity.....	34
Control Throws.....	35
Rates and Expos.....	35
Preflight.....	35
Range Test Your Radio.....	35
Safety Do's and Don'ts for Pilots.....	36
Daily Flight Checks.....	36
Limited Warranty.....	36
Warranty Services.....	37
Compliance Information for the European Union.....	37
Academy of Model Aeronautics National Model Aircraft Safety Code.....	38
Building and Flying Notes.....	39

## Introduction

Like the sword for which it's named, Mike McConville, champion aerobatic pilot, designed the Hangar 9® Katana 50, to be exceptionally lightweight without sacrificing strength or rigidity. The amazing power-to-weight ratio this construction makes possible is complemented by an airfoil that has been specially designed for aggressive 3D flight. The result is explosive aerobatic performance that will allow you to boldly explore the limits of your abilities while enjoying absolute precision and control at every corner of the envelope.

## Product Support

For technical assistance with this product, please contact the appropriate Horizon Product Support office. This information is located in the back of this manual.

## Specifications

Wingspan	59.0 in (150cm)
Wing Area	825 sq in.(53.2 sq dm)
Fuselage Length	58.0 in (147cm)
Weight Range	6.60 lb–7.50 lb (3.00–3.40 kg)
Engine/Motor Size	2-stroke glow: .46–.55 4-stroke glow: .72–.82 EP: Power 52
Radio	4+ channel with 6 servos (5 servos for EP)

## Included Parts Listing

QUANTITY		USAGE						
Fuselage with canopy	1		M2 flat washer	4	control horn	M4 black flat washer	8	Electric motor/ engine mount
Wing panel	2	Left and right			Elevator ball link/ control horn			
Wing root extension	2	Left and right	<b>BAG #7</b>			<b>BAG #11</b>		
Aileron with hinges	2	Left and right	Nylon gray control horn	2	Aileron	M3 x 12 socket head screw	4	Cowl
Rudder with hinges	1		M4 x 20 nylon bolt	2	Wing attachment	M3 black flat washer	8	Cowl/Side Force Generators
Stab and elevator with hinges	2		M2 ball links	2	Aileron	M3 x 16 socket head screw	4	Side Force Generator
Fiberglass cowl	1		M2 x 12 machine screw	2	Aileron ball link to control horn			
Aluminum painted landing gear	1				M2 lock nut	<b>BAG#12</b>		
Fiberglass wheel pant	2	Left and right	M2 flat washer	4	Aileron ball link to control horn	M4 x 12 socket head screw	3	Landing gear attachment
Carbon tube M20 x 585	1	Wing			M2 flat washer	M4 black flat washer	3	Landing gear attachment
Carbon tube M10 x 175	1	Stabilizer	Brass cone spacer	2	Aileron ball link			
			M2.5 x 12 wood screw	4	Aileron control horn	<b>BAG#13</b>		
<b>BAG #1</b>			M2 x 70 pushrod	2	Aileron	M4 x 20 socket head screw	4	Engine mount to firewall
Nylon engine mount	2	2 and 4 stroke engine mount	Nylon clevis with safety tubing	2	Aileron	M3 x 25 socket head screw	4	Engine to engine mount
2mm plywood template	2	Engine/motor template				M3 flat washer	8	Engine to engine mount
			<b>BAG #8</b>			Pushrod connector with setscrew	1	Throttle
<b>BAG#2</b>			CA hinges	3	Extra	M4 blind nut	4	Electric motor/ engine mount
2mm wire with wheel collar	1	Tail wheel	Nylon gray control horn	2	Rudder	M3 lock nut	4	Engine to engine mount
			M2 ball links	1	Rudder			
<b>BAG #3</b>			M2 x 12 machine screw	4	Rudder ball link to control horn	<b>BAG#14</b>		
M2 wheel collar with setscrew	2	Tail wheel	M2 lock nut	1	Rudder ball link to control horn	62mm plywood standoff box	1	EP motor mount
M10 x 40 aluminum plate	1	Tail wheel bracket	M2 flat washer	2	Rudder ball link to control horn	<b>BAG#15</b>		
M3 x 12 wood screw	2	Tail wire bracket to fuselage	Brass cone spacer	1	Rudder ball link	150mm pushrod housing	1	Throttle
			M2.5 x 12 wood screw	4	Rudder control horn	1.5mm x 300mm Z-bend pushrod	1	Throttle
<b>BAG #4</b>			2.5mm x 85mm pushrod	1	Rudder	25mm x 250mm hook and loop strap	1	Receiver
M4 x 35 wheel axle	2	Main wheel	2.5mm brass connector	2	Rudder pull/pull cable ends	25mm x 150mm hook and loop strap	1	EP or receiver battery
M4 wheel collar with setscrew	4	Main wheel	2.5mm tubing crimp	4	Rudder pull/pull crimp	4mm plywood hooks	4	Fuel tank
M4 flat washer	2	Axle to landing gear	1190mm braided cable	2	Rudder pull/pull	Rubber bands	4	Fuel tank
M4 lock nut	2	Axle to landing gear	Nylon clevis with safety tubing	2	Rudder	3mm plywood disc	1	Firewall plug for fuel lines
M2 x 8 washer head wood screw	2	Wheel pant to landing gear						
			<b>BAG #9</b>			<b>BAG #16</b>		
<b>BAG #5</b>			2mm plywood tray	1	Receiver tray	380cc fuel tank	1	
2.50-inch (65mm) foam wheel	2	Main wheel	2mm plywood (yellow) plate	1	Rudder mini servo adapter	3mm x 50mm aluminum tubing	3	
1.25-inch (30mm) foam wheel	1	Tail wheel				Rubber <b>GLOW</b> stopper	1	
			<b>BAG #10</b>			Fuel tank metal plate	2	
<b>BAG #6</b>			M4 x 12 socket head screw	4	Electric motor stand off	Clunk	1	
M2.5 x 12 wood screw	4	Elevator control horn	M4 lock washer	4	Electric motor stand off	M3 x 20 screw	1	
Nylon gray control horn	2	Elevator				100mm surgical tubing	1	Internal clunk line
M2 x 115 pushrod	2	Elevator						
Nylon clevis with safety tubing	2	Elevator						
M2 ball link	2	Elevator						
M2 x 12 machine screw	2	Elevator ball link/ control horn						
M2 lock nut	2	Elevator ball link/ control horn						

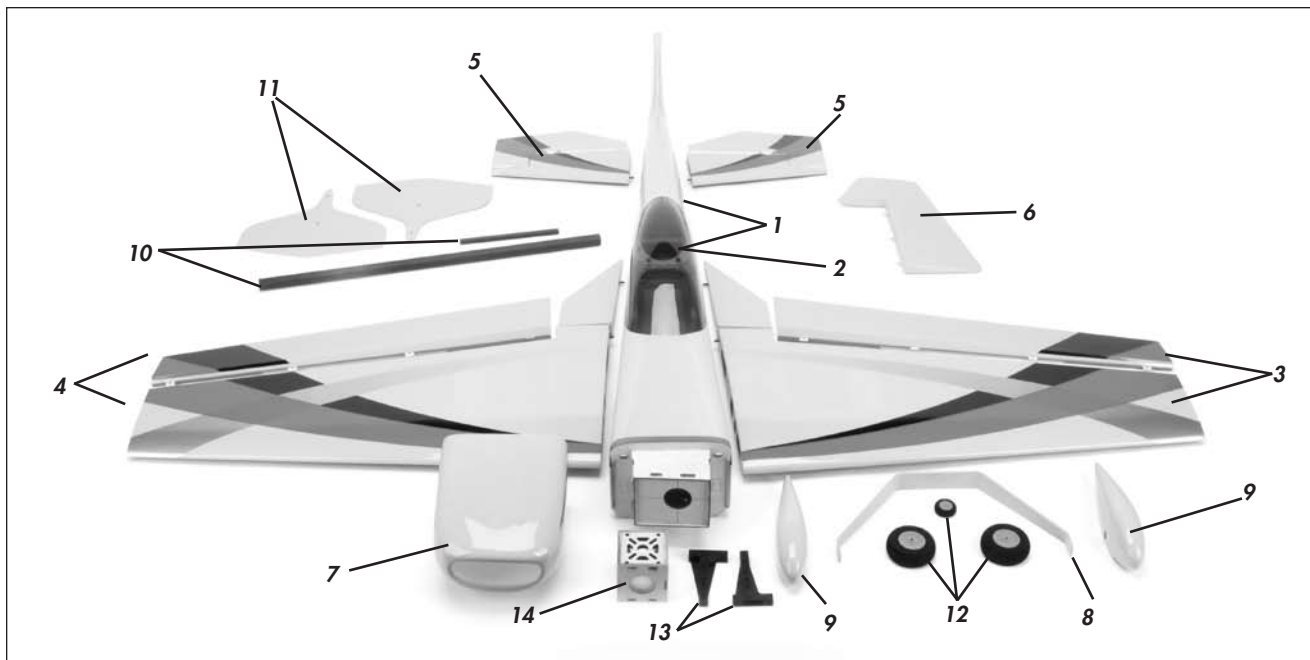

## Contents of Kit and Parts Listing

### Replacement Parts

1. HAN417001	Fuselage with Top Hatch
2. HAN417002	Fuselage Top Hatch
3. HAN417003	Left Wing Panel with Aileron
4. HAN417004	Right Wing Panel with Aileron
5. HAN417005	Stabilizer with Elevator (right and left)
6. HAN417006	Rudder
7. HAN417007	Cowl
8. HAN417008	Landing Gear with Axles
9. HAN417009	Wheel Pants (right and left)
10. HAN417010	Wing and Stabilizer Carbon Tube
11. HAN417011	Side Force Generators™ (optional)
12. HAN417013	Main Wheels and Tail Wheel
13. HAN417014	Engine Mount with Hardware
14. HAN417015	EP Motor Mount with Hardware

### Items Not Shown

HAN417012	Fuel Tank—380cc
HAN417016	Complete Hardware
HAN417017	Pushrods
HAN417018	Nylon Wing Retention Bolts (2)

## Safety Precautions and Warnings

Read and follow all instructions and safety precautions before use. Improper use can result in fire, serious injury and damage to property.

**Age Recommendation: Not for children under 14 years. This is not a toy.**

### COMPONENTS

Use only with compatible components. Should any compatibility questions exist, please refer to the product instructions, the component instructions or contact Horizon Hobby, Inc.

### FLIGHT

Fly only in open areas to ensure safety. It is recommended flying be done at AMA (Academy of Model Aeronautics) approved flying sites. Consult local ordinances before choosing a flying location.

### PROPELLER

Keep loose items that can get entangled in the propeller away from the prop, including loose clothing, or other objects such as pencils and screwdrivers. Especially keep your hands away from the propeller as injury can occur.

### BATTERIES

#### Notes on Lithium Polymer Batteries

When used improperly, lithium polymer batteries are significantly more volatile than alkaline or Ni-Cd/Ni-MH batteries used in RC applications. Always follow the manufacturer's instructions when using and disposing of any batteries. Mishandling of Li-Po batteries can result in fire causing serious injury and damage.

### SMALL PARTS

This kit includes small parts and should not be left unattended near children as choking and serious injury could result.

## Safe Operating Recommendations

- Inspect your model before every flight to ensure it is airworthy.
- Be aware of any other radio frequency user who may present an interference problem.
- Always be courteous and respectful of other users in your selected flight area.
- Choose an area clear of obstacles and large enough to safely accommodate your flying activity.
- Make sure this area is clear of friends and spectators prior to launching your aircraft.
- Be aware of other activities in the vicinity of your flight path that could cause potential conflict.
- Carefully plan your flight path prior to launch.
- Abide by any and all established AMA National Model Aircraft Safety Code.

## Important Information Regarding Warranty

Please read our Warranty and Liability Limitations in the back of this manual before building this product. If you as the purchaser or user are not prepared to accept the liability associated with the use of this Product, you are advised to return this Product immediately in new and unused condition to the place of purchase.

## Using the Manual

This manual is divided into sections to help make assembly easier to understand and to provide breaks between each major section. In addition, check boxes have been placed next to each step to keep track of each step completed. Steps with a single box (□) are performed once, while steps with two or more boxes (□□) indicate the step will require repeating, such as for a right or left wing panel, two servos, etc. Remember to take your time and follow the directions.

## UltraCote® Covering Colors

Cub Yellow	HANU884
True Red	HANU866
Black	HANU874
Silver	HANU881

## Recommended Power Setups

### 2-STROKE GLOW

Evolution® .52NX with Muffler	EVOE0520
Pitts Muffler: EVO40/46/52	BIS04046
Evolution 11 x 6 propeller	EVO11060
Hangar 9 2 1/4-inch aluminum spinner	HAN99001
1/4 x 28 Prop Adapter Kit	HAN99053
Fuel Filler with T-fitting and Overflow	HAN116
Silicone Fuel Tubing	DUB222

### 4-STROKE GLOW

Saito™ .82 AAC with Muffler	SAIE082B or SAIE082BGK
Muffler Right Angle Manifold	SAI65163
Evolution 14 x 6 propeller	EVO14060
Hangar 9 2 1/4-inch aluminum spinner	HAN99001
7 x 1mm Prop Adapter Kit	HAN99050
Fuel Filler with T-fitting and Overflow	HAN116
Exhaust Deflector: .35 to .90 Engines	DUB697
Silicone Fuel Tubing	DUB222

### ELECTRIC

Power 52 BL Outrunner Motor, 670Kv	EFLM4052A
80-Amp Pro Switch-Mode BEC ESC	EFLA1080B
Prop Adapter: Power 46/60	EFLM1934
APC 15 x 7 propeller	APC15070E
Hangar 9 2 1/4-inch aluminum spinner	HAN99001
8 x 1.25mm Prop Adapter Kit	HAN99052
5000mAh 5S 18.5V 30C	EFLB50005SP30
9-inch (228mm) Servo Extension	JRPA096

## Transmitter Requirements

This model requires a minimum of a 4-channel radio to operate all the functions of your aircraft. We suggest the following radio systems available through Horizon Hobby or your local hobby distributor.

Spektrum DX6i	SPM6610
Spektrum DX8	SPM8800
JR® DSM2 or DSMX Systems	

## Radio Equipment Requirements

The following items are recommended when installing the 8-Channel AR8000 (SPMAR8000).

JR Chargeswitch	JRPA004
A5030 Mini Digital Aircraft Servo (2)	SPMSA5030
A6060 Standard Digital Servo (2)	SPMSA6060
A6010 Digital Aircraft Servo	SPMSA6010
A6000 Digital Aircraft Servo	SPMSA6000
Receiver Battery, 2300mAh, 3.0V Ni-Cd	JRPB5006
HD Servo Arms with Screws (3)	JRPA215
24-inch (610mm) Servo Extension (2)	JSP98040
6-inch (152mm) Servo Extension (2)	JSP98110
or	
6-inch (152mm) Y-harness	JSP98020

### Servo Placement and Extensions:

Aileron:	A6060 Standard Digital Servo (2) 6-inch (152mm) (2) receiver to servo or 6-inch (152mm) Y-harness
Rudder:	A6010 Digital Aircraft Servo
Elevator:	A5030 Mini Digital Aircraft Servo (2) 24-inch (610mm) (2) servo to receiver
Throttle:	A6000 Digital Aircraft Servo (not required for EP installations)

### The elevator installation will require:

Two servos and mixing through the radio

### Optional Rudder servo (Tail mounted)

A5030 Mini Digital Aircraft Servo	SPMSA5030
24-inch (610mm) Servo Extension	JSP98040

## Optional Equipment

1/5 Civilian Pilot, Green	HAN9120
Telemetry for the DX8	SPM9548

## Field Equipment Required

Fuel (15% recommended)	
Saito Glow Plug	SAIP400S
Long Reach Glow Plug Wrench	HAN2510
Metered Glow Driver with Charger	HAN7101
2-Cycle Sport Plug	EVOGP1
Ultra Fuel Pump (gas and glow)	HAN155
Evolution Oil	EVOX1001Q

## Optional Field Equipment

PowerPro™ 12V Starter	HAN161
12V 7Ah Sealed Battery	HAN102
Power Panel	HAN106
Blue Block After Run Oil	EVOX1001
Self-stick weights, 6 oz	HAN3626
Charger	EFL3025
Spray cleaner	
Paper towels	

## Required Adhesives

<input type="checkbox"/> 30-minute Epoxy	PAAPT39
<input type="checkbox"/> Thin CA	PAAPT08
<input type="checkbox"/> Medium CA	PAAPT02
<input type="checkbox"/> Canopy Glue	PAAPT56
<input type="checkbox"/> Silicone adhesive	DEVS250
<input type="checkbox"/> Threadlock	PAAPT42

## Required Tools

- Card stock
- C-clamp
- Covering Iron
- Crimping tool
- Cutoff wheel
- Denatured alcohol
- Dental floss
- Dish washing detergent
- Drill bit: 5/64-inch (2mm), 1/8-inch (3mm), 9/64-inch (3.5mm), 11/64-inch (4.5mm)
- Epoxy brushes
- Felt-tipped pen
- Flat file
- Hex wrench: 1.5mm, 2.5mm, 3mm, 5/32-inch
- Hobby knife with #11 blade
- Hobby scissors
- Hook and loop strap
- Hook and loop tape
- Light machine oil
- Low-tack tape
- Medium grit sandpaper
- Mixing cups
- Mixing sticks
- Needle nose pliers
- Nut driver: 4mm, 7mm
- Open-end wrench: 10mm, 12mm
- Paper towels
- Pencil
- Phillips screwdriver: #1, #2
- Pin vise
- Propeller reamer
- Rotary tool
- Ruler
- Sanding drum
- Scissors
- Side cutters
- Spray bottle
- Straight edge
- Tie wraps
- Toothpicks
- T-pins
- Two-sided tape

## Before Starting Assembly

Before beginning the assembly of your model, remove each part from its bag for inspection. Closely inspect the fuselage, wing panels, rudder and stabilizer for damage. If you find any damaged or missing parts, contact the place of purchase.

If you find any wrinkles in the covering, use a heat gun (HAN100) and covering glove (HAN150) or covering iron (HAN101) with a sealing iron sock (HAN141) to remove them. Use caution while working around areas where the colors overlap to prevent separating the colors.

## Selecting the Correct Propeller

The Katana 50 was designed specifically for the 3D flight envelope, which favors thrust over speed. Flying your aircraft at high speeds may cause flutter due to the extremely large control surfaces. To keep the speed down and thrust up, use low-pitch propellers.

## Binding the Radio System

Before starting the assembly of your model, we recommend preparing your radio system for installation. This includes charging the transmitter and receiver batteries, as well as centering the trims and sticks on your transmitter. If using a computer radio, make sure to reset a model memory and name it for this particular model. We also recommend binding the transmitter and receiver at this time following the instructions provided with your radio system.

➔ *We highly recommend re-binding the radio system once all the control throws are set. This will keep the servos from moving to their endpoints until the transmitter and receiver connect.*

## Wing Root Extension Installation

### Required Parts

Wing panel, right and left  
Wing root extension, right and left  
Fuselage  
Carbon tube, M20 x 585

- 1. Locate the items for this section of the manual.

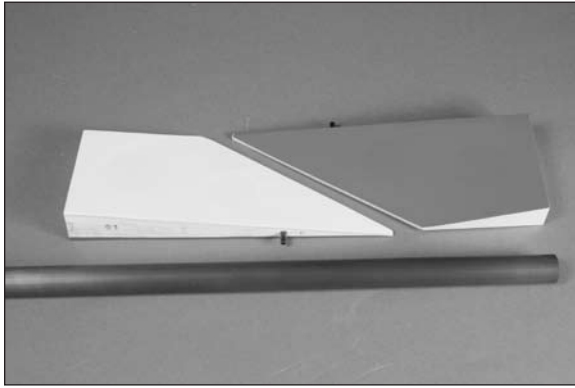

- 2. Fold the covering back and use tape to secure it to the wing. Slide the carbon tube into the wing panel. The tube socket has a cap on it, so do not force the tube in any farther than it will easily slide.

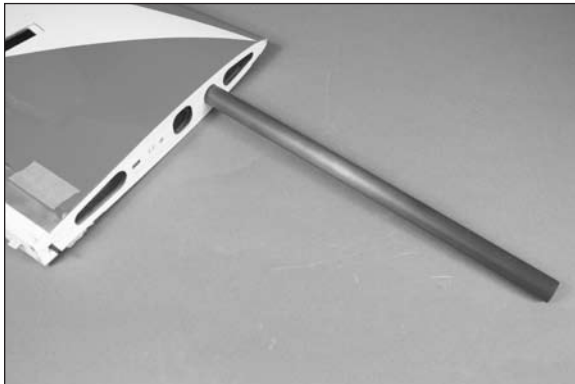

- 3. Slide the wing into position on the fuselage. Don't slide the wing tight against the fuselage at this time. Use plastic to prevent gluing the wing to the fuselage. Fit the wing root extension to the wing. Check the fit of the wing root extension by sliding the wing and extension tight against the fuselage. The outside edge will align between the wing and extension as shown.

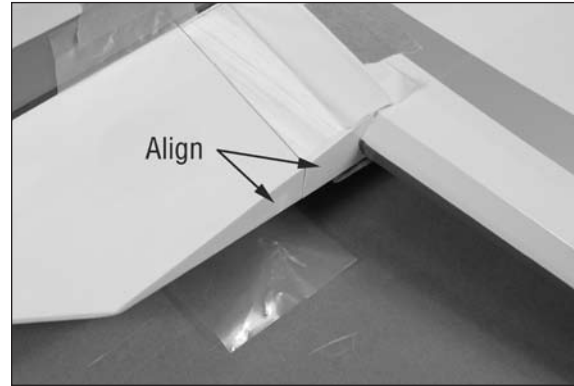

- 4. Slide the wing away from the fuselage and remove the extension. Mix 1/2 ounce (15mL) of 30-minute epoxy. Use an epoxy brush to apply a thin coat of epoxy to the adjoining surfaces of the wing and the extension. Reposition the extension and slide the wing tightly against the fuselage. Use a paper towel and denatured alcohol to remove any excess epoxy. Use low-tack tape to hold the extension in position until the epoxy fully cures.

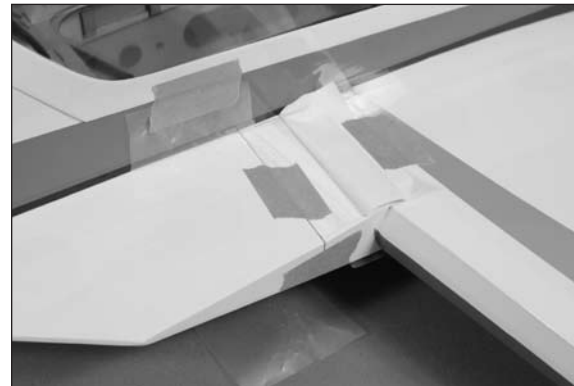

- 5. Once the epoxy has cured, remove the wing panel from the fuselage. Remove the tape, then use a covering iron to seal the covering from the wing to the wing root extension.



- 6. Repeat steps 2 through 5 to prepare the opposite wing panel. Remember to remove the plastic from the fuselage once both wings are complete.

## Aileron Hinging

### Required Parts

Wing panel, right and left  
Aileron, right and left  
CA hinge (8)

1. Locate the items for this section of the manual.

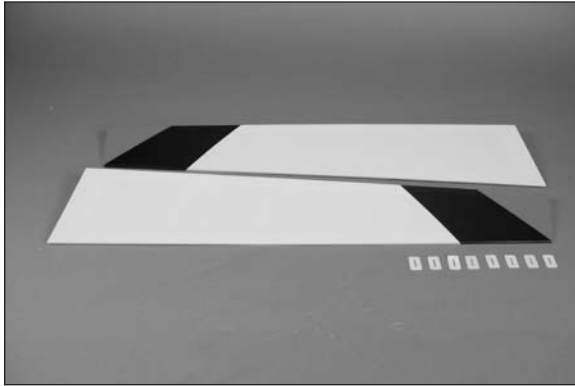

2. Use a pin vise and 1/16-inch (1.5mm) drill bit to drill a hole in the center of the four hinge slots in the aileron and wing. This will create a tunnel for the CA to wick into, fully saturating the hinge.



3. Prepare the four hinges by placing a T-pin in the center of each hinge. This will center the hinge when the aileron and wing are joined. Place the hinges in the hinge slots in the aileron. The T-pin will rest on the leading edge of the aileron as shown.

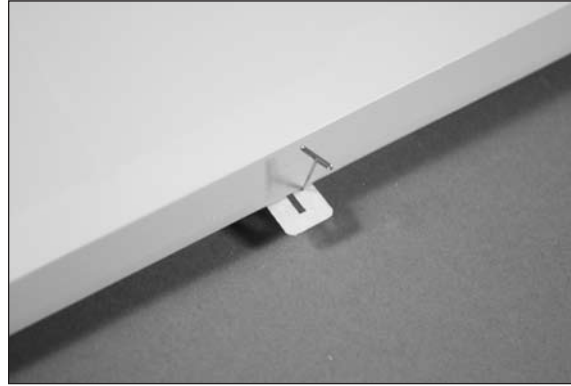

4. Use the hinges to fit the aileron to the wing.

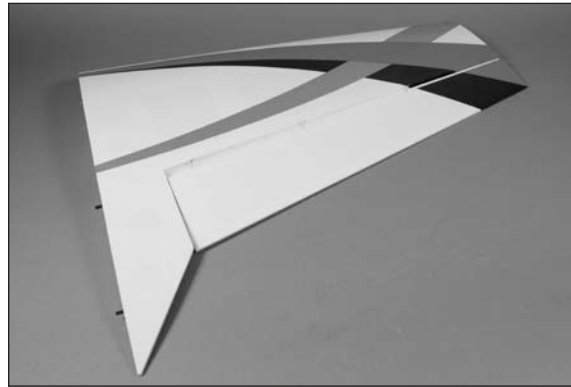

→ The position of the aileron will be determined based on whether the **OPTIONAL Side Force Generators (SFG)** will be used. The ailerons must be positioned properly so they do not rub against the Side Force Generators when they are installed.

- 5a. (No Side Force Generators) Position the aileron so it aligns with the wing tip. Use a straight edge to make sure they are aligned as shown.

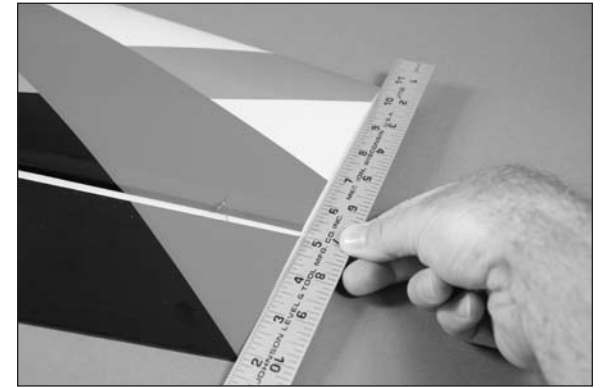

- 5b. (Side Force Generators) Position the aileron so it is set back 1/16-inch (1.5mm) from the wing tip. Use a straight edge at the wing tip to make sure the aileron is set back and can move freely without contacting the straight edge.

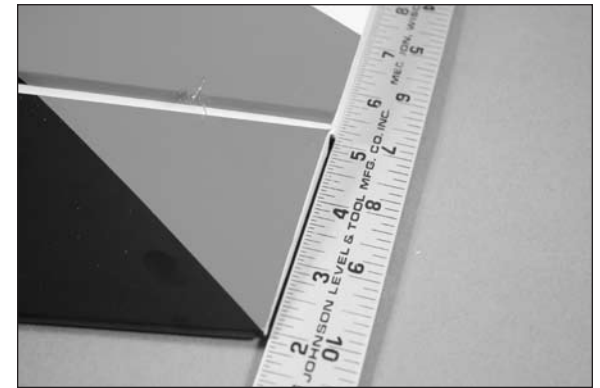

→ If the aileron is positioned as described in step 5a, it is possible to still use the Side Force Generators if a washer is placed between the SFG and wing tip to space the SFG away from the aileron.



→ Do not use CA accelerator when gluing the hinges. Always allow the CA to soak into the hinge for the best bond between the hinge and surrounding wood.

□□ 6. Remove the T-pins from the hinges and make sure the aileron gap is as small as possible. Saturate the top and bottom of each hinge using thin CA. Allow the CA to cure before proceeding. Check that the hinges are secure by gently pulling on the control surface. If not, apply thin CA to any hinges that are not glued and recheck. Move the control surface through its range of motion several times to break in the hinges. This will reduce the initial load on the servo during your first flights.

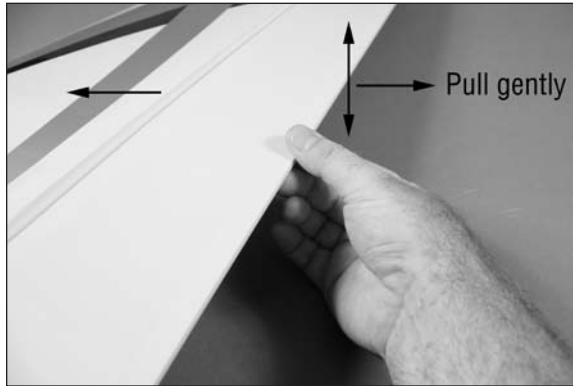

□ 7. Repeat steps 2 through 6 to install the remaining wing panel.

## Aileron Servo Installation

### Required Parts

Servo with hardware	Receiver
Receiver battery	Transmitter
M2 ball links (2)	M2 lock nut (2)
M2 flat washer (4)	Cone spacer (2)
Wing panel, right and left	
M2 x 70 pushrod (2)	
Nylon gray control horn (2)	
M2.5 x 12 wood screw (4)	
M2 x 12 machine screw (2)	
Nylon clevis with safety tubing (2)	

□ 1. Locate the items for this section of the manual.

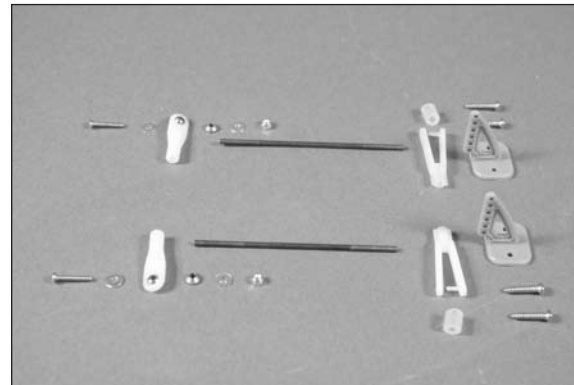

□□ 2. Prepare the aileron servo by installing the rubber grommets and brass eyelets. Guide the servo lead and extension through the wing from the opening for the servo out through the small square hole in the root rib as shown.

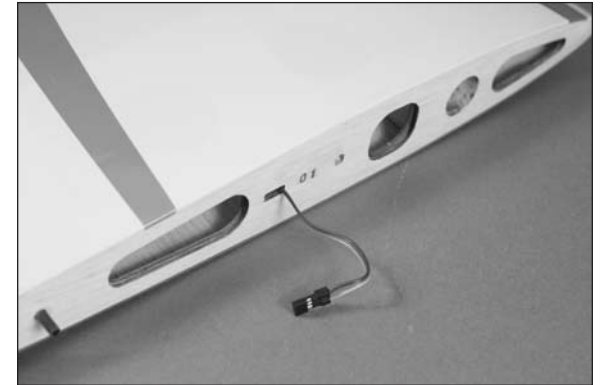

□□ 3. Place the servo in the opening with the output shaft of the servo facing toward the trailing edge of the wing. With the aileron servo centered in the opening, use a pencil to mark the locations for the four mounting screws. Remove the servo from the wing. Use a pin vise and 1/16-inch (1.5mm) drill bit to drill the holes for the mounting screws. Use care not to accidentally drill through the top of the wing.

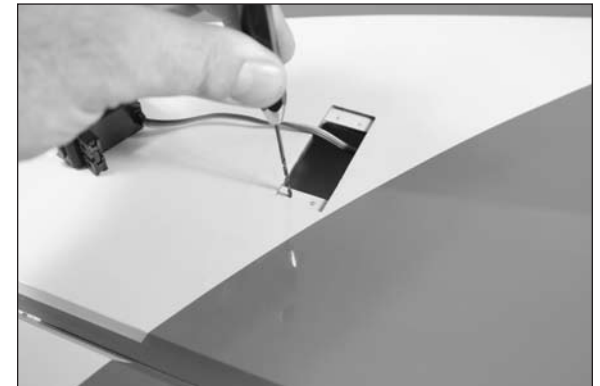

□□ 4. Use a #1 Phillips screwdriver to thread a servo mounting screw into each of the holes to cut threads in the surrounding wood. Remove the screw before moving to the next step. Apply 2–3 drops of thin CA in each of the holes to harden the surrounding wood. This will harden the threads so the screws do not easily strip the surrounding wood.

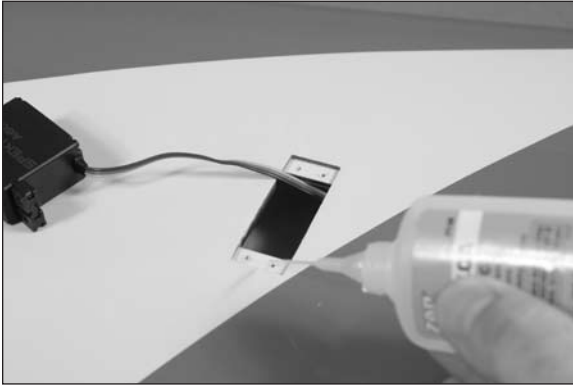

□□ 5. Install the aileron servo using a #1 Phillips screwdriver and the four mounting screws provided with the servo. The output shaft of the servo faces the trailing edge of the wing.

□□ 6. Plug the aileron servo into the receiver, with the radio system on, center the aileron stick and trim. Place the HD servo horn on the servo. The horn will be perpendicular to the servo centerline as shown. If not, rotate the arm 180 degrees and recheck the alignment. Once aligned, mark the side of the servo horn facing the wing root, as it will need to be trimmed in the following steps.

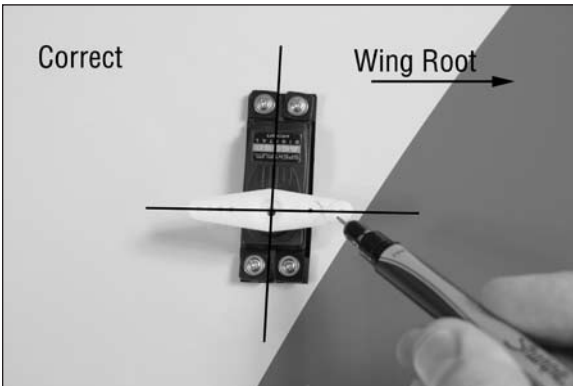

□□ 7. Assemble the aileron linkage as shown using a 2mm x 70mm pushrod, M2 ball link and a nylon clevis. Make sure to slide a piece of safety tubing on the clevis before threading it on the pushrod. Adjust the length of the pushrod so it measures 4 inches (101mm) as shown in the photo below.

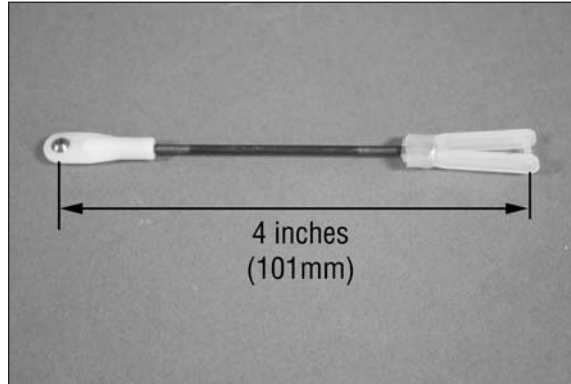

□□ 8. Remove the arm from the servo and remove the marked arm using side cutters. Use a pin vise and a 5/64-inch (2mm) drill bit to enlarge the hole that is 13/16-inch (20mm) from the center of the horn. Use a cone spacer between the ball end and servo horn with the narrow edge of the spacer against the ball link. Secure the linkage to the servo arm using an M2 x 12 machine screw, two M2 washer and M2 locknut. Tighten the hardware using a #1 Phillips screwdriver and a 4mm nut driver.

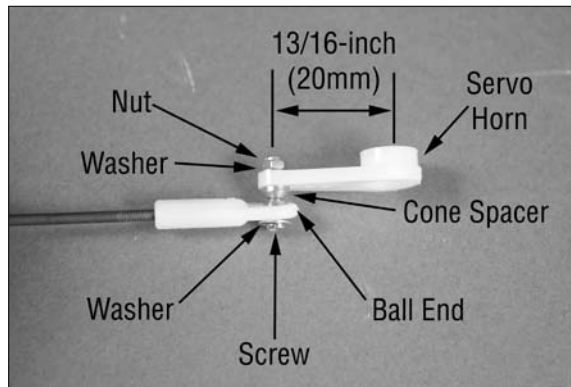

□□ 9. Secure the servo horn to the servo using the screw provided with the servo and a #1 Phillips screwdriver.



□□ 10. Use a square along the aileron hinge line to align the linkage perpendicular to the hinge line. Use a felt-tipped pen to mark the aileron where the center of the clevis is positioned.



□□ 11. Move the aileron linkage out of the way. Position the control horn so it is centered on the line drawn in the previous step. With the front edge of the horn aligned with the taper of the hinge line, use a felt-tipped pen to mark the locations for the two mounting screws.



□□ 12. Use a pin vise and 1/16-inch (1.5mm) drill bit to drill 1/2-inch (13mm) deep holes in the aileron for the servo horn mounting screws. Use a #1 Phillips screwdriver to thread an M2 x 12 wood screw into each of the holes. Remove the screw before proceeding to the next step. Apply 2–3 drops of thin CA in each of the holes to harden the surrounding wood. Allow the CA to cure without the use of an accelerator for best results.

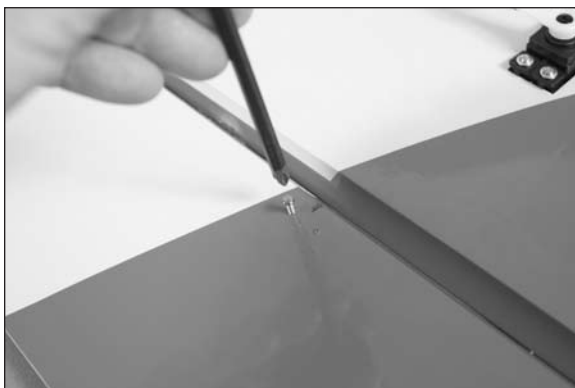

□□ 13. Attach the control horn using two M2 x 12 wood screws and a #1 Phillips screwdriver. With the radio system on and the aileron servo centered, attach the aileron linkage to the hole in the control horn that is two up from the bottom of the horn as shown in the drawing. Adjust the length of the linkage so the aileron is centered, then slide the safety tubing over the forks of the clevis.

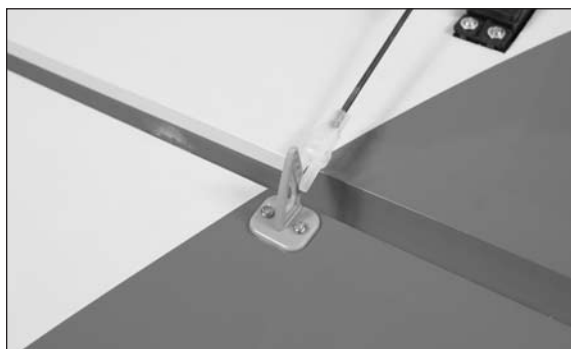
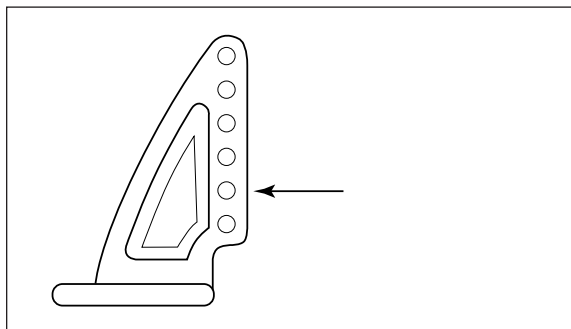

□ 14. Repeat steps 2 through 13 to install the remaining aileron servo and linkage.

□ 15. Once the aileron servos are installed, remember to turn off the transmitter and receiver.

## Rudder and Tail Wheel Installation

### Required Parts

Fuselage	Rudder
CA hinge (3)	
2mm tail wheel wire with wheel collar	
2mm wheel collar with setscrew (2)	
10mm x 40mm aluminum plate	
M3 x 12 wood screw (2)	
1.25-inch (30mm) foam wheel	

□ 1. Locate the items for this section of the manual.

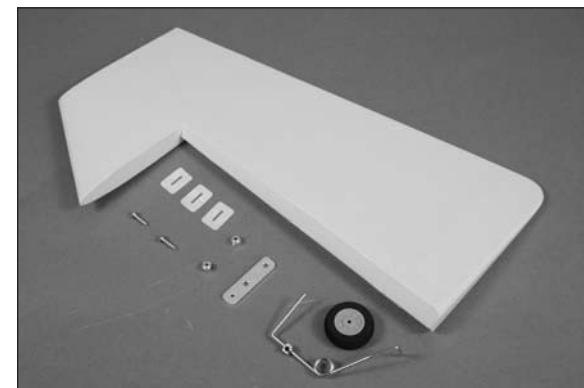

□ 2. Measure up 7/8-inch (22mm) and use a 5/64-inch (2mm) drill bit to drill a hole in the rudder at the hinge line for the tail wheel wire. Make sure to drill the hole perpendicular to the hinge line.

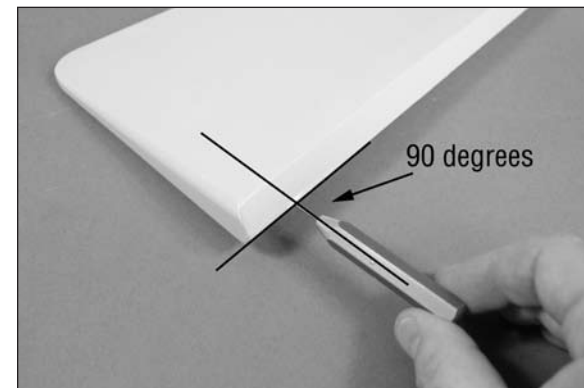

□ 3. Use a hobby knife and a #11 blade to cut a groove from the hole to the bottom of the rudder for the tail wheel wire to rest in.

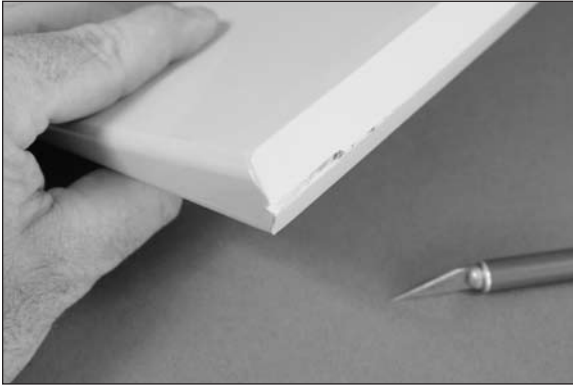

□ 4. Check the fit of the tail wheel wire in the rudder. Use a straight edge to make sure it is flush with the rudder hinge line. It may be necessary to use a 1.5mm hex wrench to loosen the wheel collar and slide it against the coil spring.

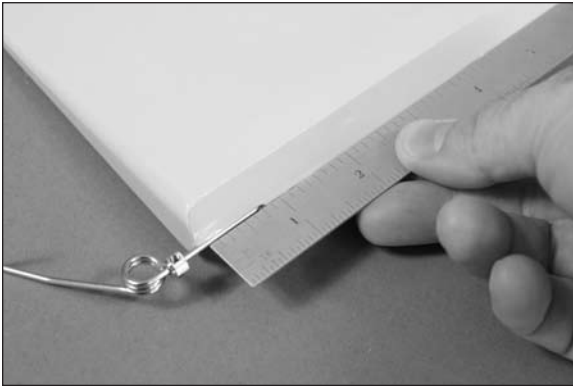

□ 5. Remove the tail wheel wire from the rudder. The 10mm x 40mm aluminum plate must be installed before the wire is glued in position. Insert the wire through the small hole in the plate, working the plate around the bend in the wire. You will need to rotate the plate a few times to work it past the bend. Use medium grit sandpaper to roughen the wire where it contacts the rudder. This will allow the epoxy to adhere to the wire when it is glued into position.

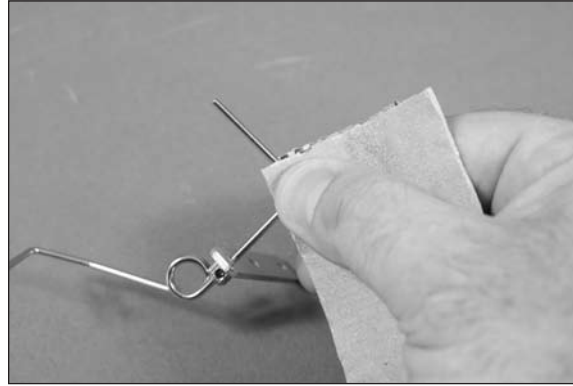

□ 6. Mix a small amount of 30-minute epoxy. Use a toothpick to apply the epoxy to the wire and into the hole in the rudder where they contact each other. Insert the tail wheel wire into the rudder. Use a paper towel and rubbing alcohol to remove any excess epoxy before it can cure. Use low-tack tape to hold the wire in position until the epoxy has fully cured. Prepare the rudder and fuselage for the hinges by drilling a hole in the center of each hinge slot using a pin vise and 1/16-inch (1.5mm) drill bit.

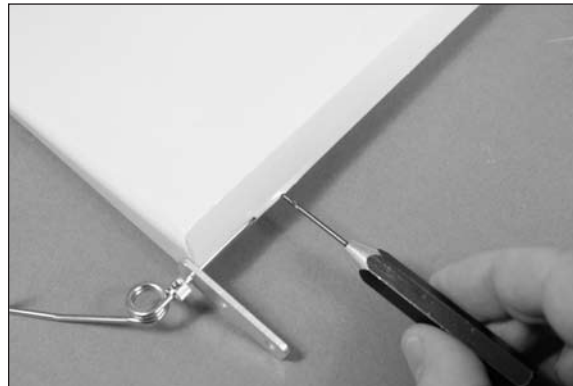

□ 7. Prepare the three hinges by placing a T-pin in the center of each hinge. This will center the hinge when the rudder and fuselage are joined. Place the hinges in the hinge slots in the rudder. The T-pin will rest on the leading edge of the rudder as shown.

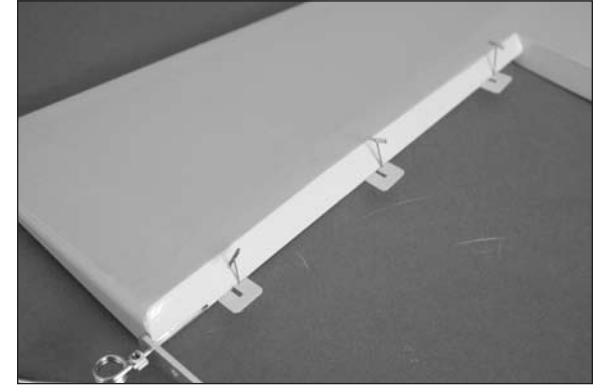

□ 8. Use the hinges to fit the rudder to the fuselage. Remove the T-pins from the hinges once the rudder is pressed against the fuselage.



➔ *Do not glue the rudder hinges until instructed to do so.*

□ 9. Position the aluminum plate so the holes align with the fuselage centerline. Use a felt-tipped pen to mark the locations for the two mounting screws on the bottom of the fuselage.

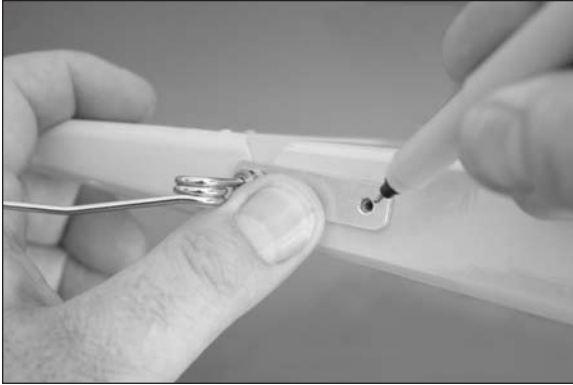

□ 10. Move the aluminum plate out of the way of the fuselage. Use a pin vise and 5/64-inch (2mm) drill bit to drill two holes in the bottom of the fuselage for the aluminum plate mounting screws. Use a #2 Phillips screwdriver to thread an M3 x 12 wood screw into each of the holes. Remove the screw before proceeding to the next step. Apply 2–3 drops of thin CA in each of the holes to harden the surrounding wood. Allow the CA to cure without the use of an accelerator for the best results. Attach the aluminum plate using two M3 x 12 wood screws. Use a #2 Phillips screwdriver to tighten the screws.

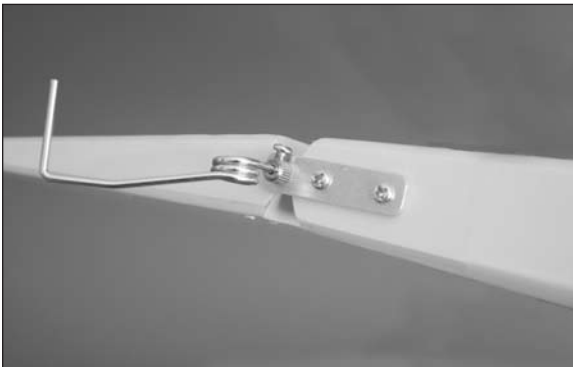

➔ *If the bottom of the rudder is below the fuselage, installing the screws will cause the rudder to move up slightly.*

□ 11. Position the rudder so there is a small gap between the aluminum plate and the bottom of the rudder. It should almost touch, but provide enough clearance so the rudder can move freely.

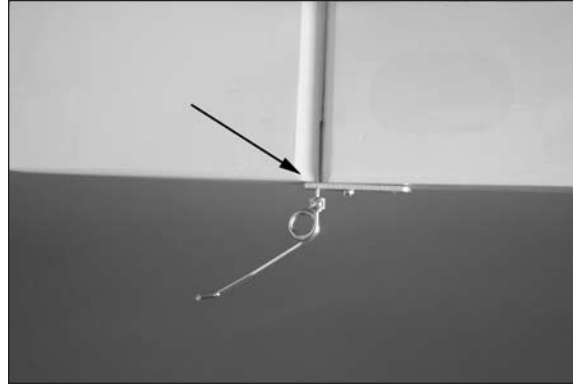

□ 12. Saturate each hinge using thin CA. Allow the CA to cure before proceeding. Make sure to apply CA to both sides of the hinge. Check that the hinges are secure by gently pulling on the control surface. If not, apply thin CA to any hinges that are not glued and recheck. Move the control surface through its range of motion several times to break in the hinges. This will reduce the initial load on the servo during your first flights.

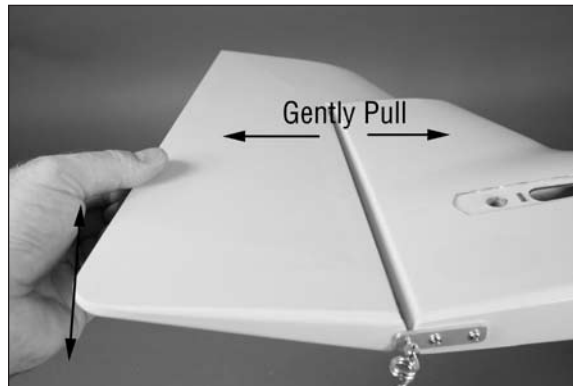

➔ *Always use threadlock on metal-to-metal fasteners to prevent them from vibrating loose.*

□ 13. Use a #1 Phillips screwdriver to loosen the setscrew in the wheel collar. Slide the wheel collar against the aluminum plate and tighten the setscrew. Make sure the rudder can move freely, without the wheel collar binding on the aluminum plate.

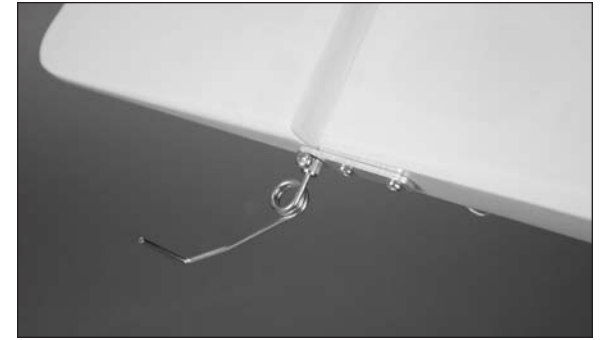

□ 14. Place a drop of light machine oil on the tail wheel axle. Use two 2mm wheel collars to secure the 1.25-inch (30mm) tail wheel to the tail wheel wire. Use a #1 Phillips screwdriver to tighten the setscrews. Make sure the tail wheel can rotate freely when installed.

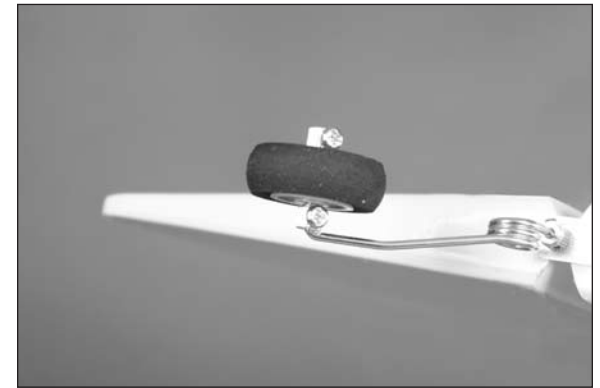

## Main Landing Gear Installation

### Required Parts

Fuselage	4mm x 35mm wheel axle (2)
M4 flat washer (2)	M4 lock nut (2)
2.50-inch (65mm) foam wheel (2)	
M4 black flat washer (3)	
4mm wheel collar with setscrew (4)	
M4 x 12 socket head screw (3)	
M2 x 8 washer head wood screw (2)	

- 1. Locate the items for this section of the manual.

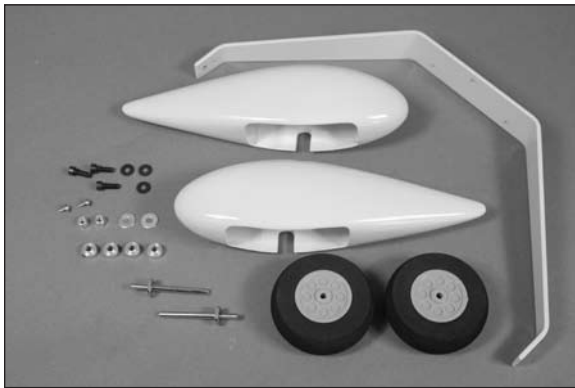

→ Always use threadlock on metal-to-metal fasteners to prevent them from vibrating loose.

- 2. Attach the main gear to the fuselage using three M4 x 12 socket head screws and three M4 black flat washers. Use an M3 hex wrench to tighten the screws.

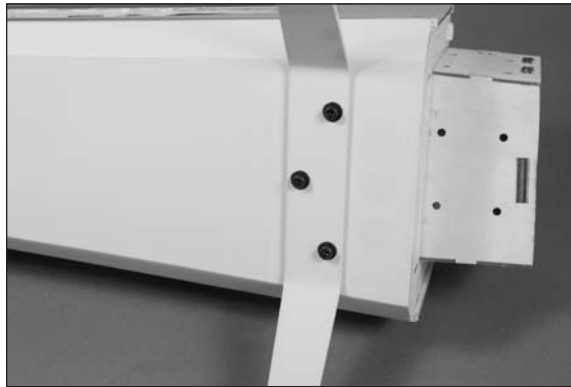

- 3. The 4mm x 35mm wheel axle is attached to the main landing gear using an M4 lock nut and M4 flat washer. Use a 7mm nut driver and a 10mm open-end wrench to tighten the hardware that attaches the axle to the landing gear. Make sure the flat area on the axle faces vertical and parallel to the landing gear leg as shown.



- 4. Prepare the axle by filing two 5/16-inch (8mm) wide sections on the axle. The first section is against the mounting flange of the axle, while the second section is the first 1/4-inch (6mm) of the axle as shown.

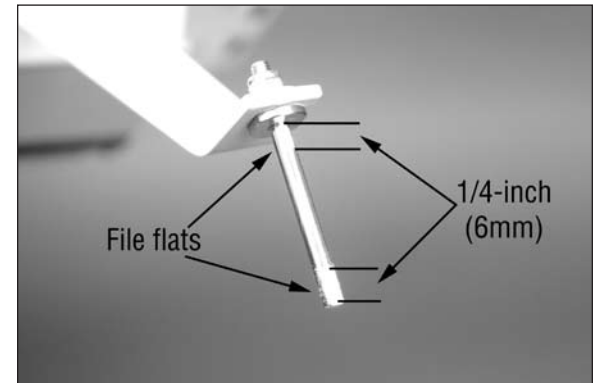

□□ 5. Slide the first 4mm wheel collar on the axle, with the rounded side of the collar facing toward the wheel. Tighten the setscrew on the flat of the axle with a #1 Phillips screwdriver, leaving a 1mm gap between the wheel collar and the mounting flange of the axle. Place a drop of light machine oil on the axle. The wheel can now be positioned and secured using another 4mm wheel collar and a #1 Phillips screwdriver. The wheel should rotate freely on the axle.

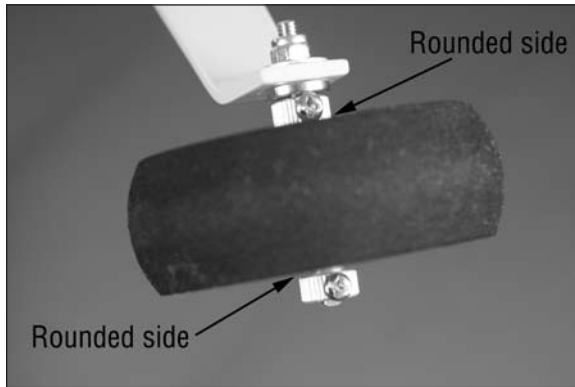

□ 6. Repeat steps 3 through 5 to install the remaining wheel and axle.

□□ 7. Slide the wheel pant over the wheel. The slot in the wheel pant will fit to the mounting flange of the axle. With the fuselage resting on a flat surface, measure from the work surface to the wheel pant as shown. Position the wheel pant so the distance measures 1.125 inches (29mm). Use a felt-tipped pen to mark the wheel pant through the small hole in the landing gear.

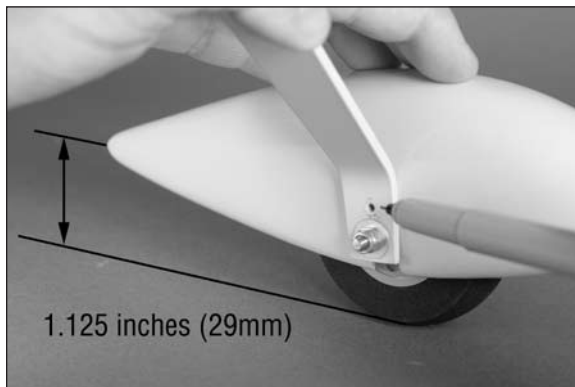

➔ *It may be necessary to reposition the axle slightly using the 10mm open-end wrench to position the wheel pant.*

□□ 8. Remove the wheel pant from the landing gear. Use a drill and 1/16-inch (1.5mm) drill bit to drill the hole for the wheel pant mounting screw. Use a #1 Phillips screwdriver to thread an M2 x 8 washer head wood screw into the hole drilled in the previous step. Remove the screw before proceeding to the next step. Apply 2–3 drops of thin CA in the hole to harden the surrounding wood. Allow the CA to cure without the use of an accelerator for the best results. Attach the wheel pant to the landing gear using an M2 x 8 washer head wood screw. Use a #1 Phillips screwdriver to tighten the screw. Check that the wheel is centered in the wheel pant.

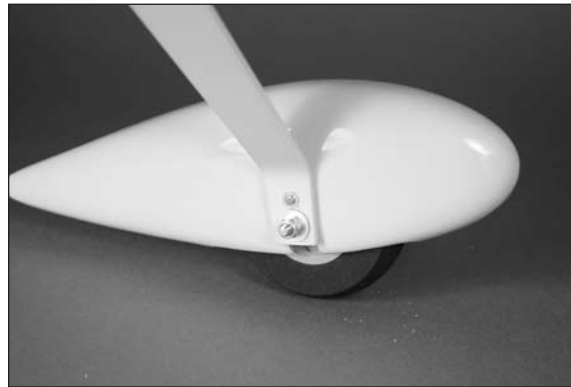

□ 9. Repeat steps 7 and 8 to attach the remaining wheel pant to the landing gear.

## Radio Installation

### Required Parts

Fuselage assembly	Receiver
Receiver battery	Switch harness
Hook and loop strap (not included)	
24-inch (610mm) servo extension (2)	
2mm plywood receiver tray	
Rudder servo with hardware	
Elevator servo with hardware (2)	
6-inch (152mm) servo extension (2) or	
6-inch (152mm) Y-harness	

□ 1. Locate the items for this section of the manual.

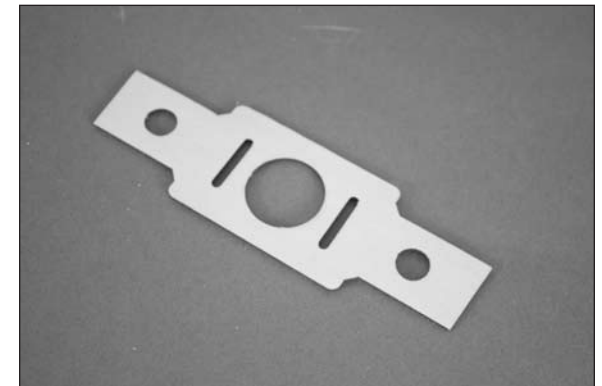

□ 2. Use a #1 Phillips screwdriver to thread a switch mounting screw into the holes in the radio tray. Remove the screw before proceeding to the next step. Apply 2–3 drops of thin CA in each of the holes to harden the surrounding wood. Allow the CA to cure without the use of an accelerator for the best results. Mount the switch in the fuselage using the switch mounting screws and a #1 Phillips screwdriver.



→ The location of the receiver battery is determined by your choice of engine and how the airframe balances. It may be necessary to relocate the battery to achieve the best balance for your model. The battery location shown may or may not be correct for your choice of power systems.

□ 3. Mount the battery in the fuselage using a hook and loop strap (not included). Make sure to use a piece of foam rubber between the radio tray and battery to protect it from vibration. Connect the lead from the battery to the switch harness.

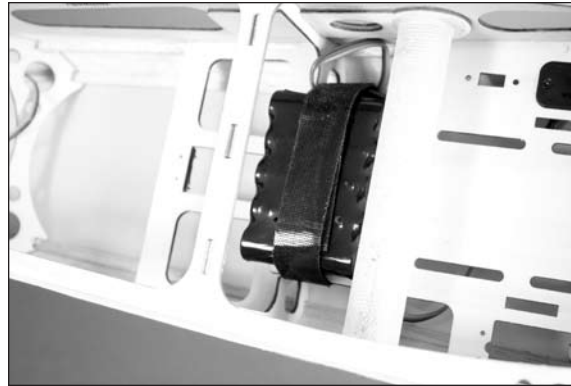

→ The location of the rudder servo shown in this manual was designed to work for most engine applications. If you find the need to add excessive weight to the tail of the aircraft to balance your model, there is an alternate location for the installation of the rudder servo behind the elevator servos. The opening in the fuselage is sized for a standard size servo, and an adapter plate has been provided for use with the suggested mini servo.

□ **Optional:** Use a hobby knife with a #11 blade to remove the covering for the rudder servo. Trim the covering back so the adapter plate can be glued in position to the bare wood using medium CA. Secure a 24-inch (610mm) extension to the rudder servo. Install the servo, then assemble the linkage using a clevis, ball end and 2.5mm x 85mm threaded rod (see elevator pushrod for details). Adjust the rod so the rudder is centered when the rudder servo is centered.

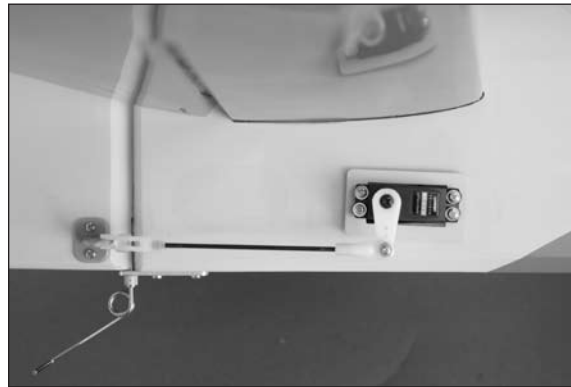

□ 4. Prepare the rudder servo by installing the brass eyelets and grommets. Position the servo so it is centered in the opening for the servo. Use a pencil to mark the locations for the four mounting screws. Remove the servo from the fuselage. Use a pin vise and 1/16-inch (1.5mm) drill bit to drill the holes for the servo mounting screws. Use a #1 Phillips screwdriver to thread a servo mounting screw into each of the holes to cut threads in the surrounding wood. Remove the screw before moving to the next step. Apply 2–3 drops of thin CA in each of the holes to harden the surrounding wood. This will harden the threads so the screws do not easily strip the surrounding wood. Install the rudder servo using a #1 Phillips screwdriver and the four mounting screws provided with the servo. The output shaft on the servo will face toward the rear of the fuselage.



□ □ 5. Prepare the elevator servo by installing the rubber grommets and brass eyelets. Secure a 24-inch (610mm) servo extension to the servo lead using dental floss so it doesn't accidentally become disconnected inside the fuselage.

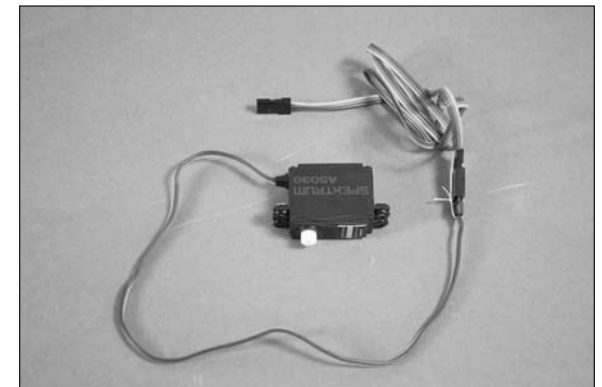



□□ 6. Use a hobby knife and #11 blade to remove the covering from the fuselage side for the elevator servo opening.



□□ 7. Route the lead for the elevator servo through the fuselage, under the formers. Fit the elevator servo in the opening with the output shaft facing toward the rear of the fuselage.

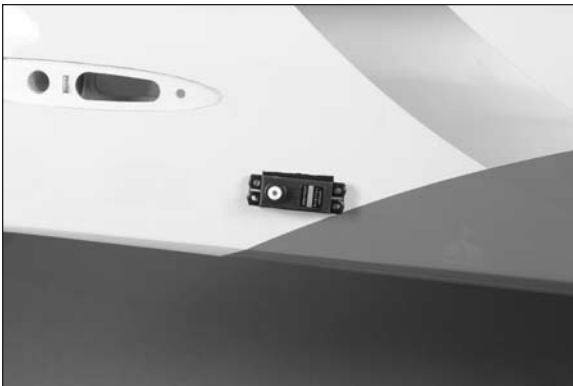
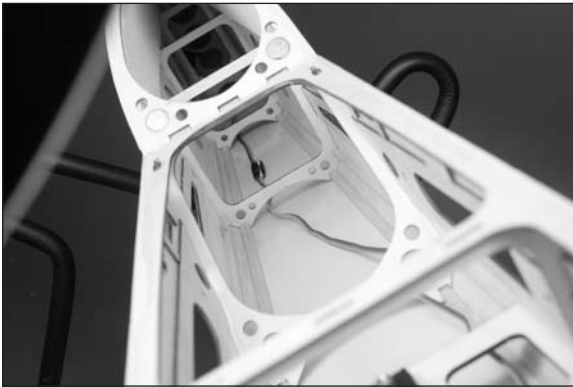

□□ 8. Use a felt-tipped pen to mark the location for the elevator servo mounting screws. Partially remove the servo from the fuselage. Use a pin vise and 1/16-inch (1.5mm) drill bit to drill the holes for the servo mounting screws. Use a #1 Phillips screwdriver to thread a servo mounting screw into each of the holes to cut threads in the surrounding wood. Remove the screw before moving to the next step. Apply 2-3 drops of thin CA in each of the holes to harden the surrounding wood. This will harden the threads so the screws do not easily strip the surrounding wood. Install the elevator servo using a #1 Phillips screwdriver and the four mounting screws provided with the servo. The output shaft on the servo will face toward the rear of the fuselage.



□ 9. Repeat step 6 through 8 to install the remaining elevator servo.

□ 10. Plug the rudder and elevator servos into the appropriate ports of the receiver. Also plug the Y-harness into the aileron port (or 6-inch extensions in the aileron and AUX1 ports), and the switch harness into the battery port.

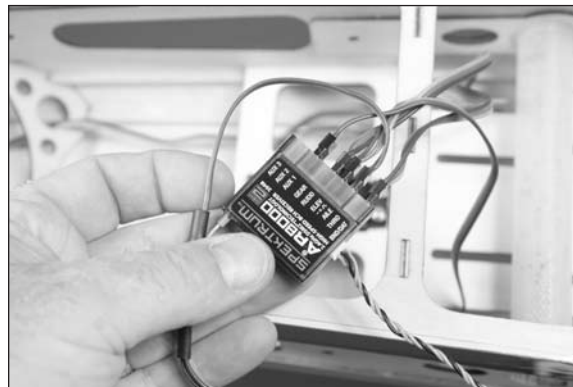

□ 11. Use medium CA to glue the 2mm plywood receiver tray in the fuselage. Wrap the receiver in foam, then use a hook and loop strap (not included) to secure the receiver to the plywood receiver tray. Note the position of the receiver and its relationship to the angle on the ends of the tray.



□ 12. Use hook and loop tape (not included) to attach the remote receiver to the plate on the inside of the fuselage. Make sure to offset the receiver down 1/8-inch (3mm) from the top rail of the fuselage so it doesn't interfere with the stringer along the upper side of the fuselage.



## Rudder Cable Installation

### Required Parts

Fuselage assembly	Nylon gray control horn (2)
2.5mm tubing crimp (4)	1190mm cable (2)
Transmitter	2.5mm brass connector (2)
M2 x 12 machine screw (4)	
M2.5 x 12 wood screw (4)	
Nylon clevis with safety tubing (2)	

1. Locate the items for this section of the manual.

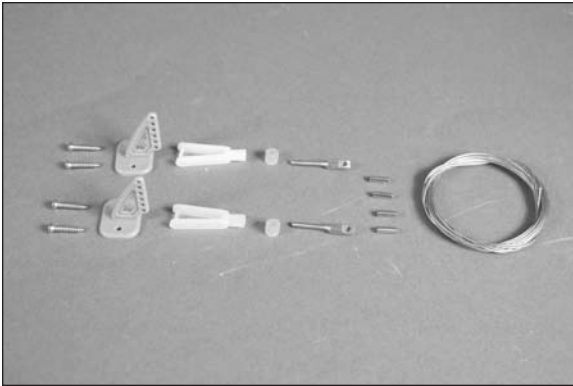

2. Measure up 1/2-inch (13mm) from the bottom of the rudder and use a felt-tipped pen to mark the location for the center of the control horn.



3. Center the control horn on the mark made in the previous step. With the front edge of the horn aligned with the taper of the hinge line, use a felt-tipped pen to mark the locations for the two mounting screws.

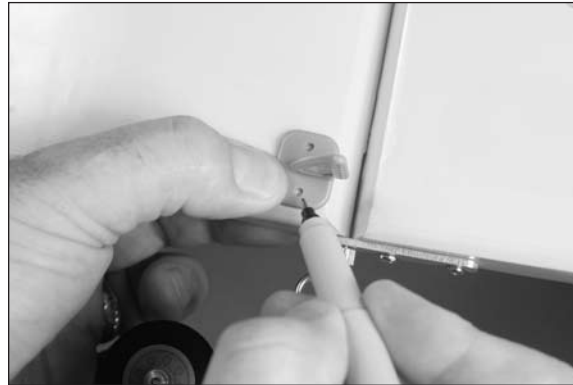

4. Use a pin vise and 1/16-inch (1.5mm) drill bit to drill two 1/2-inch (13mm) deep holes in the rudder for the servo horn mounting screws. Use a #1 Phillips screwdriver to thread an M2.5 x 12 wood screw into each of the holes. Remove the screw before proceeding to the next step. Apply 2-3 drops of thin CA in each of the holes to harden the surrounding wood. Allow the CA to cure without the use of an accelerator for best results. Attach the control horn using two M2.5 x 12 wood screws and a #1 Phillips screwdriver.



5. Repeat steps 2 through 4 to install the remaining control horn.

6. Use a hobby knife and #11 blade to remove the covering from the fuselage for the rudder cable opening.

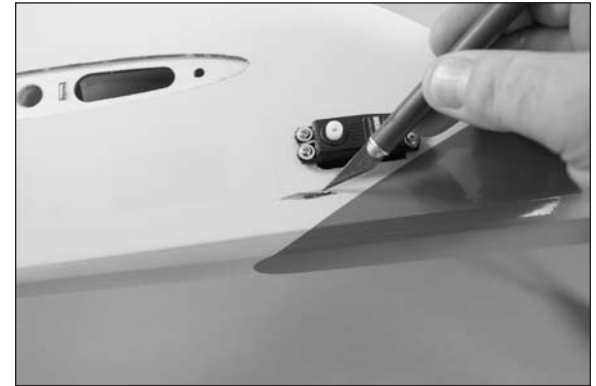

7. Insert the cable through the opening. Use a small piece of low-tack tape to secure the end of the cable so it doesn't fall out while maneuvering the fuselage. Make sure the cable is routed through the center of the formers.

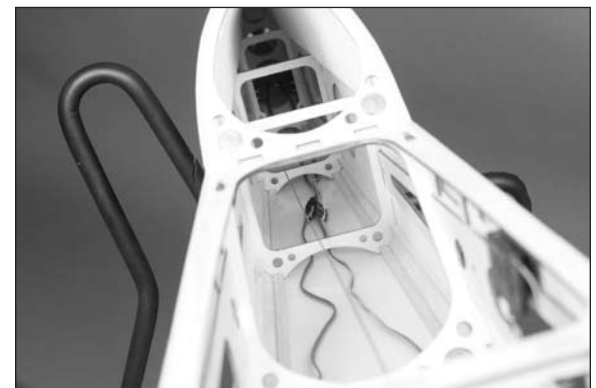
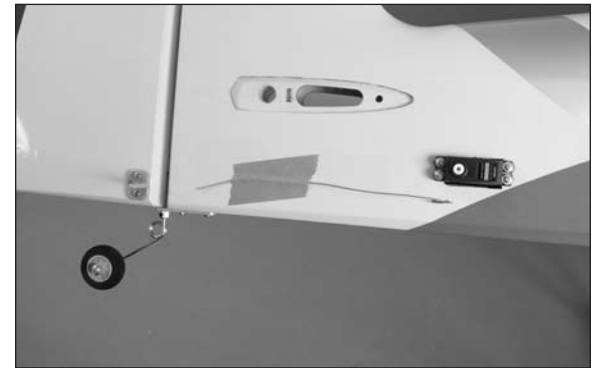

□ 8. Repeat steps 6 and 7 to install the remaining control horn and place the remaining cable.

□ 9. Use the radio system to center the rudder servo. Place the HD servo horn on the servo. The horn will be perpendicular to the servo centerline as shown. If not, rotate the arm 180 degrees and recheck the alignment. One position will be closer than the other, as the servo output shaft has an odd number of splines. Slide one of the brass crimps on one of the rudder cables. Pass the cable through the hole in the servo horn that is 3/4-inch (19mm) from the center of the horn. The cable will be on the same side the cable exits the fuselage. The cable then goes back through the crimp. Prepare both cables at this time.

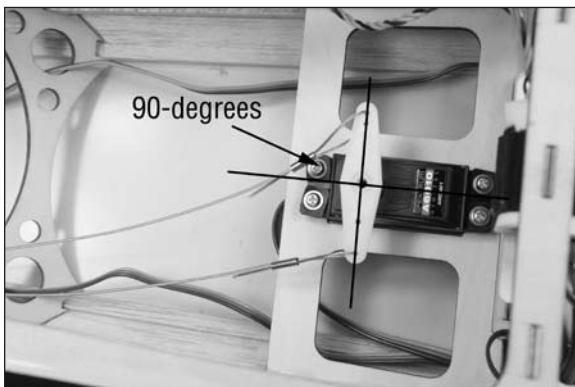

□ 10. Remove the servo horn from the fuselage. The cables can now be looped through the crimp a second time. Keep the amount of excess cable at a minimum, then use crimping pliers to secure the crimps to the cable.

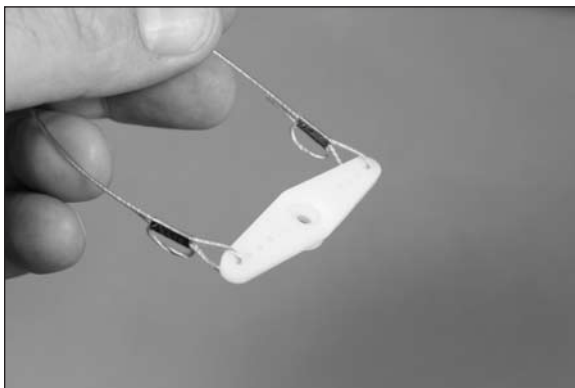

□ 11. Once the cable is secure, place the servo horn back on the servo. Use the screw provided with the servo and a #1 Phillips screwdriver to secure the servo horn to the servo.



□□ 12. Slide a piece of safety tubing onto a nylon clevis. Thread the 2.5mm brass connector into the clevis until the end of the connector is just visible between the forks of the clevis.

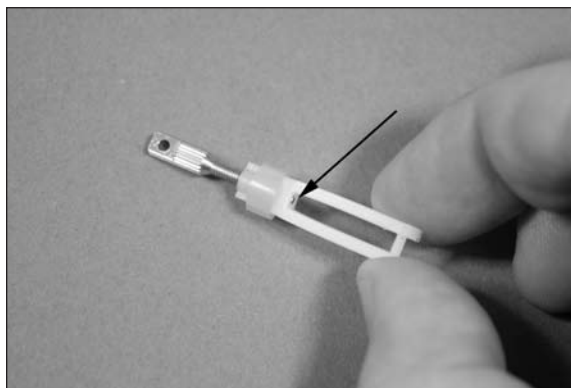

□□ 13. Attach the clevis to the hole in the control horn that is two up from the bottom of the horn as shown in the drawing.

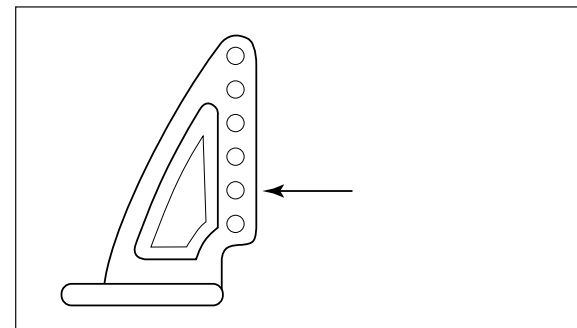

□□ 14. Remove the tape holding the cable to the fuselage. Slide a brass crimp on the cable, then pass the cable through the brass connector. The cable then goes back through the crimp. Do not tension the cable until instructed to do so.

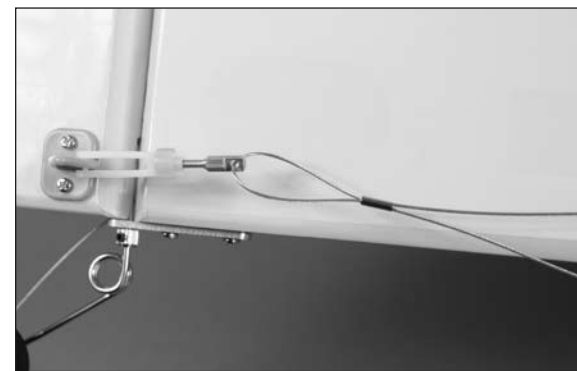

□ 15. Repeat steps 12 through 14 to prepare the opposite control horn and cable.

□ 16. With the radio system on and the rudder servo centered, adjust the tension of the cables so the rudder is centered. Make sure there is a light amount of tension on the cables so the rudder has no play at neutral and will not flutter. Once the cables have been tensioned, loop the cable back through the crimp and use crimping pliers to secure the cable and crimp. Use side cutters to trim the excess cable. Check the operation of the rudder using the radio system. Make sure the rudder centers in both directions. The clevises and brass connectors can be adjusted to make sure the rudder centers, as well as to adjust the tension on the cables. Slide the safety tubing over the clevis to keep the clevis from opening accidentally. Use side cutters to trim the excess cable.

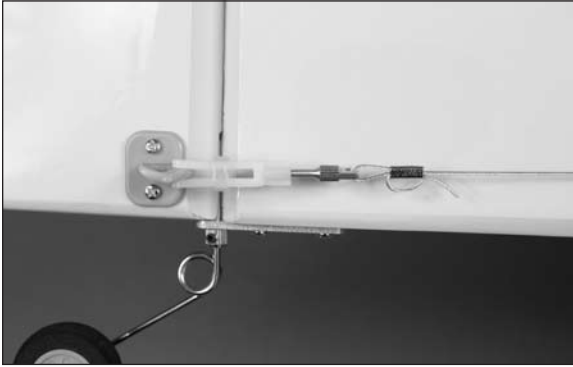

→ Check the tension on the cables periodically and adjust as necessary.

## ***Elevator and Stabilizer Installation***

### **Required Parts**

Fuselage assembly	M2 ball link (2)
M2 lock nut (2)	M2 flat washer (4)
CA hinge (6)	Stabilizer (right and left)
Elevator (right and left)	HD servo horn (2)
Transmitter	Nylon gray control horn (2)
Carbon tube 10mm x 175mm	
2mm x 115mm pushrod (2)	
M2 x 12 machine screw (2)	
M2.5 x 12 wood screw (4)	
Nylon clevis with safety tubing (2)	

□ 1. Locate the items for this section of the manual.

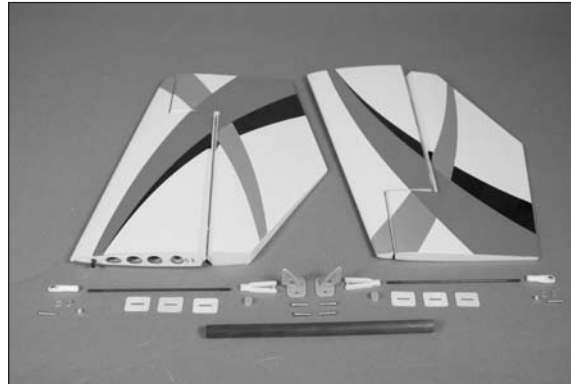

→ Read through the following steps before mixing epoxy. The epoxy must be applied and the stabilizer positioned before the epoxy begins to cure.

□ 2. Slide the carbon fiber stabilizer tube into the socket in the stabilizer. The tube socket has a cap on it, so do not force the tube in any farther than it will easily slide. Fit the stabilizer and tube to the fuselage. The stabilizer will fit tight in the recess in the fuselage. Slide the remaining stabilizer into position. Both stabilizers will fit tight against the fuselage when installed.



□ 3. Remove the stabilizer from the fuselage and tube. Mix 1/2 ounce (15mL) of 30-minute epoxy. Use an epoxy brush to apply epoxy to the bare wood on the fuselage and stabilizer. Use a mixing stick to apply the epoxy to the socket of the stabilizer. Use an epoxy brush to apply a thin coat of epoxy to the stabilizer tube. Slide the stabilizer halves and tube back into position. Use a paper towel and isopropyl alcohol to remove any excess epoxy before it begins to cure. Make sure the stabilizers remain positioned tightly against the fuselage until the epoxy has fully cured.



□□ 4. Prepare the elevator and stabilizer for the hinges by drilling a hole in the center of each hinge slot using a pin vise and 1/16-inch (1.5mm) drill bit.

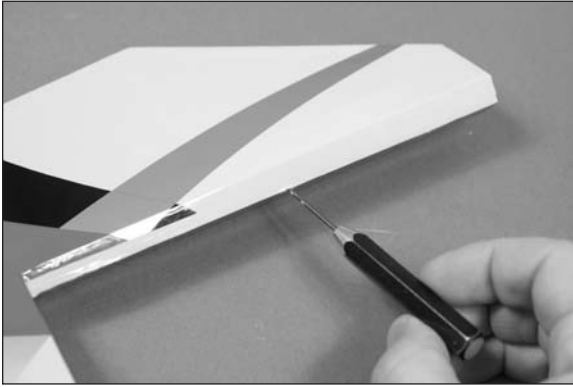

□□ 5. Prepare the three hinges by placing a T-pin in the center of each hinge. This will center the hinge when the elevator and stabilizer are joined. Place the hinges in the hinge slots in the elevator. The T-pin will rest on the leading edge of the elevator as shown.

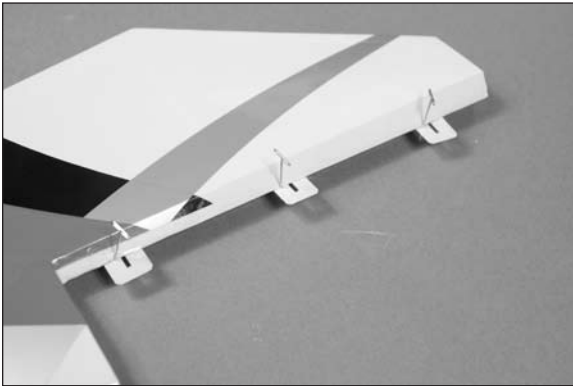

□□ 6. Use the hinges to fit the elevator to the stabilizer. Remove the T-pins from the hinges once the elevator is pressed against the stabilizer. Position the elevator so it aligns with the stabilizer tip. Use a straight edge to make sure they are aligned as shown.

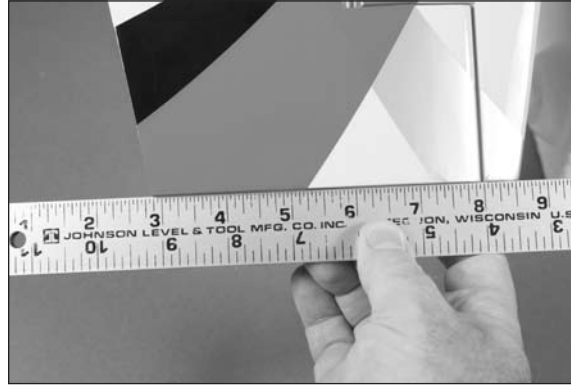

□□ 7. Saturate each hinge using thin CA. Allow the CA to cure before proceeding. Make sure to apply CA to both sides of the hinge. Check that the hinges are secure by gently pulling on the control surface. If not, apply thin CA to any hinges that are not glued and recheck. Move the control surface through its range of motion several times to break in the hinges. This will reduce the initial load on the servo during your first flights.

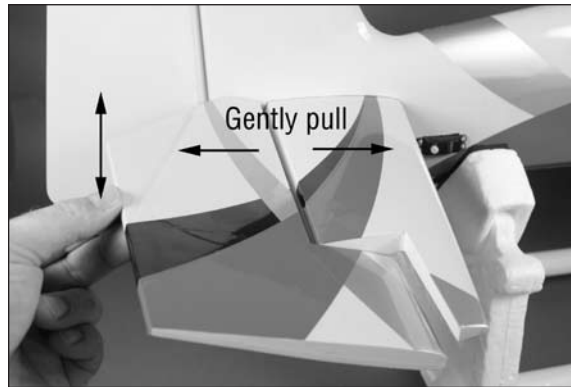

□□ 8. Measure 13/16-inch (21mm) from the side of the fuselage along the elevator bevel and use a felt-tipped pen to mark the location for the center of the control horn.

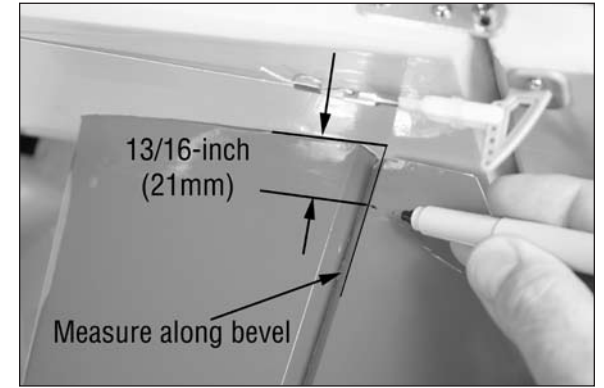

□□ 9. Center the control horn on the mark made in the previous step. With the front edge of the horn aligned with the taper of the hinge line, use a felt-tipped pen to mark the locations for the two mounting screws.

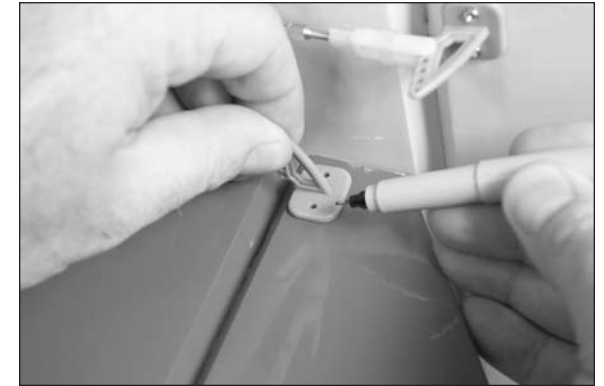

□□ 10. Use a pin vise and 1/16-inch (1.5mm) drill bit to drill 1/2-inch (13mm) deep holes in the elevator for the servo horn mounting screws. Use a #1 Phillips screwdriver to thread an M2.5 x 12 wood screw into each of the holes. Remove the screw before proceeding to the next step. Apply 2–3 drops of thin CA in each of the holes to harden the surrounding wood. Allow the CA to cure without the use of an accelerator for best results. Attach the control horn using two M2.5 x 12 wood screws and a #1 Phillips screwdriver.



□□ 11. With the radio system on and the elevator servo centered, place the HD servo horn on the servo. The horn will be perpendicular to the servo centerline as shown. If not, remove the arm from the servo and rotate it 180 degrees and recheck the alignment. One position will be closer than the other, as the servo output shaft has an odd number of splines. Once aligned, mark the side of the servo horn facing toward the bottom of the fuselage, as it will need to be trimmed in the following steps.



□□ 12. Assemble the elevator linkage as shown using a 2mm x 115mm pushrod, M2 ball link and a nylon clevis. Make sure to slide a piece of safety tubing on the clevis before threading it on the pushrod. Adjust the length of the pushrod so it measures 5.75 inches (147mm) as shown in the photo below.

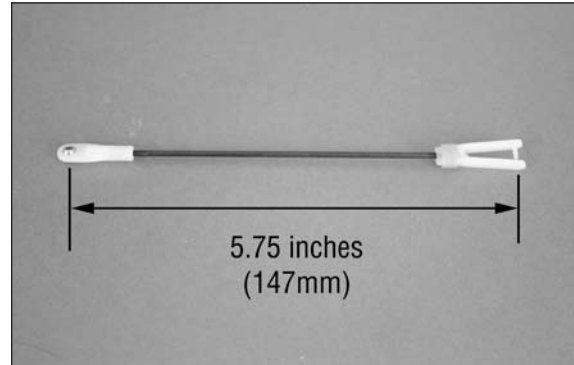

□□ 13. Remove the arm from the servo and remove the marked arm using side cutters. Use a pin vise and a 5/64-inch (2mm) drill bit to enlarge the hole that is 13/16-inch (20mm) from the center of the horn. Secure the linkage to the servo arm using an M2 x 12 machine screw, M2 washer and M2 locknut. Tighten the hardware using a #1 Phillips screwdriver and a 4mm nut driver.

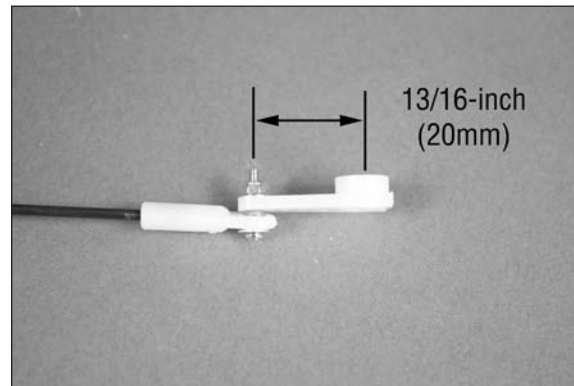

□□ 14. Secure the servo horn to the servo using the screw provided with the servo and a #1 Phillips screwdriver. Make sure the servo arm is perpendicular to the servo centerline.



□□ 15. With the radio system on and the elevator servo centered, attach the elevator linkage to the hole in the control horn that is three up from the bottom of the horn as shown in the drawing. Adjust the length of the linkage so the elevator is centered, then slide the safety tubing over the forks of the clevis.

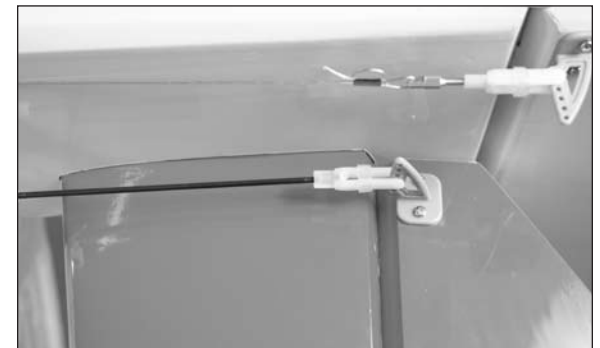
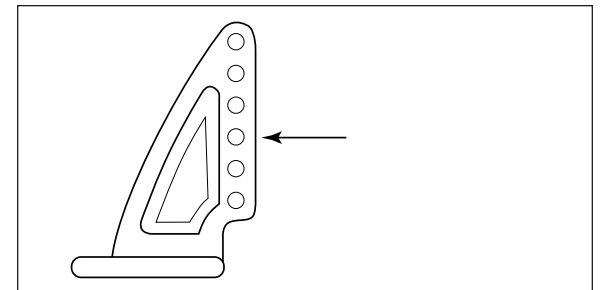

□□ 16. Repeat steps 4 through 15 to install the remaining elevator servo and linkage.

□□ 17. Once the elevator servos are installed, remember to turn off the transmitter and receiver.

## Electric Motor Installation

### Required Parts

Fuselage assembly	Plywood motor template
M4 lock washer (4)	62mm wood motor mount
Motor with hardware	M4 black flat washer (4)
Electronic speed control	Hook and loop strap
Propeller adapter	
9-inch (228mm) servo extension	
M4 x 12 socket head screw (4)	

### Required Parts (not included)

6-inch (152mm) tie wrap Hook and loop tape

- 1. Locate the items for this section of the manual.

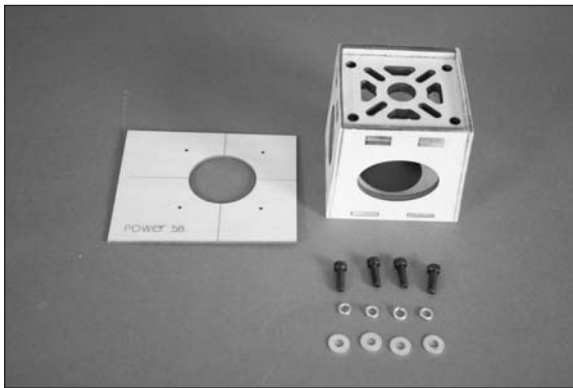

- 2. Prepare the four M4 x 12 socket head screws by placing an M4 lock washer and M4 washer on each screw.

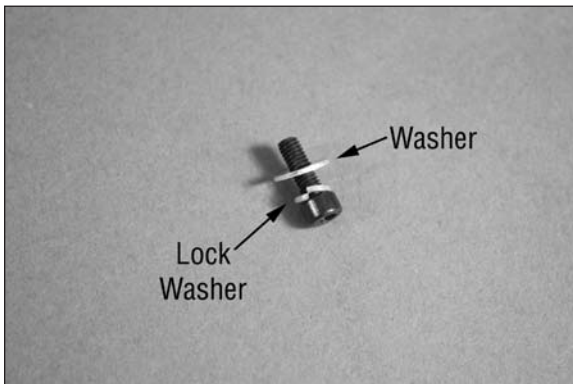

- 3. Attach the propeller adapter to the motor. The motor shaft will need to be repositioned following the instructions provided with the motor.



- 4. Attach the motor to the 62mm wood motor mount using the screws prepared in the previous step. Note the position of the wires in relationship to the motor mount.

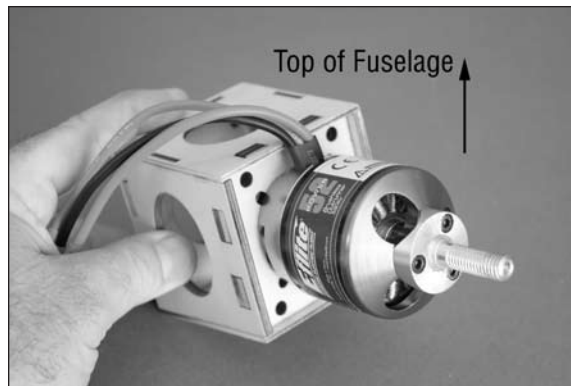
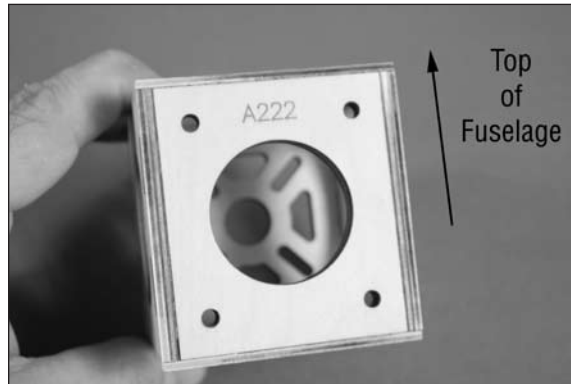

- 5. Position the appropriate plywood motor template so it fits in the opening. It may be necessary to lightly sand the edges of the template. Use a drill and 1/16-inch (1.5mm) drill bit to drill the four guide holes in through the template and into the firewall.

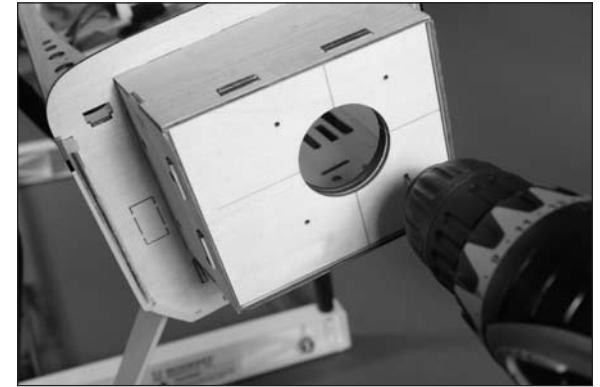

- 6. Remove the template. Use a drill and 11/64-inch (4.5mm) drill bit to enlarge the holes in the firewall.



□ 7. Use a rotary tool and cut-off wheel to trim the length of two of the bolts included with the motor to a length of 13mm. This will keep the screws from accidentally piercing the battery if it were to slide forward in the fuselage.

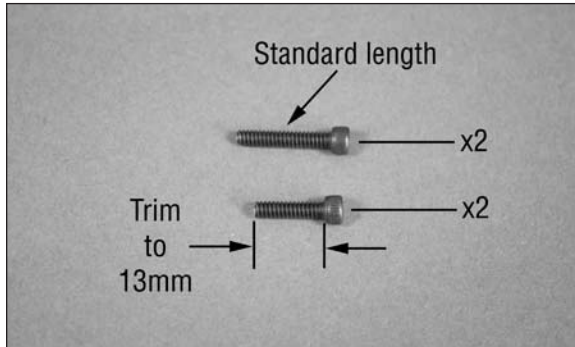

□ 8. Use the screws, washers and blind nuts included with the motor to mount the motor mount to the firewall. The two screws that were trimmed in the previous step will be the bottom two screws.



□ 9. Use a hobby knife and #11 blade to remove the material so the lead for the battery and receiver can be routed inside the fuselage.

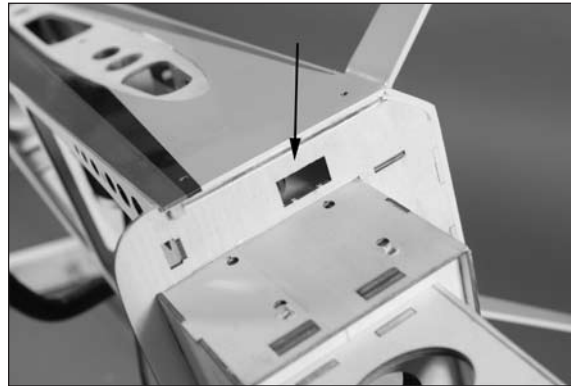

□ 10. Use hook and loop tape and tie wraps to secure the speed control to the side of the fuselage as shown. Route the connector for the battery and the lead for the receiver through the hole made in the previous step. Connect the leads from the speed control and motor, routing them so they don't interfere with the operation of the motor or the installation of the cowling.



➔ *The spacing of the laser-cut holes are wider on the left side of the fuselage to accommodate a larger speed control. The holes on the left side are closer together and more suitable for a smaller 60-amp speed controller.*

□ 11. Use a 9-inch (228mm) servo extension to connect the speed control to the receiver using string or dental floss. Make sure to secure the extension to the lead from the speed control so it doesn't disconnect accidentally. Mount the switch inside the fuselage using hook and loop tape or two-sided tape.



□ 12. Secure the motor battery in the fuselage using hook and loop straps (not included). To keep the battery from sliding on the battery tray, use hook and loop tape (not included) between the battery and battery tray.





## Glow Engine Installation

### Required Parts

Fuselage assembly	Plywood motor template
M3 flat washer (8)	M4 flat washer (4)
M4 blind nut (4)	M3 lock nut (4)
Nylon engine mount (2)	150mm pushrod housing
Engine with hardware	Plywood tank disk
1.5mm x 300mm Z-bend pushrod	
M4 x 20 socket head screw (4)	
M3 x 25 socket head screw (4)	
Pushrod connector with setscrew	

- 1. Locate the items for this section of the manual.

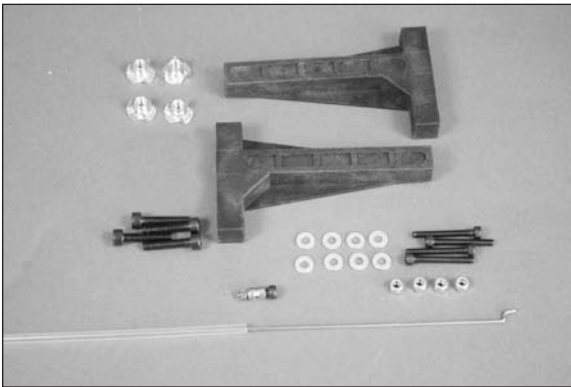

- 2. Position the appropriate plywood engine template so it fits in the opening. It may be necessary to lightly sand the edges of the template. Use a drill and 1/16-inch (1.5mm) drill bit to drill the four guide holes in through the template and into the firewall.



- 3. Remove the template. Use a drill and 11/64-inch (4.5mm) drill bit to enlarge the holes in the firewall.



- 4. Use a drill and 9/64-inch (3.5mm) drill bit to drill the hole for the throttle pushrod.

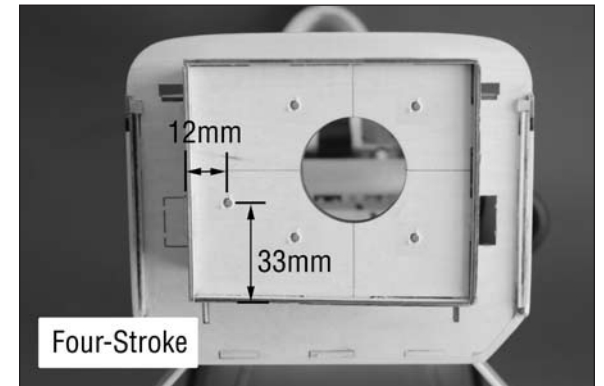
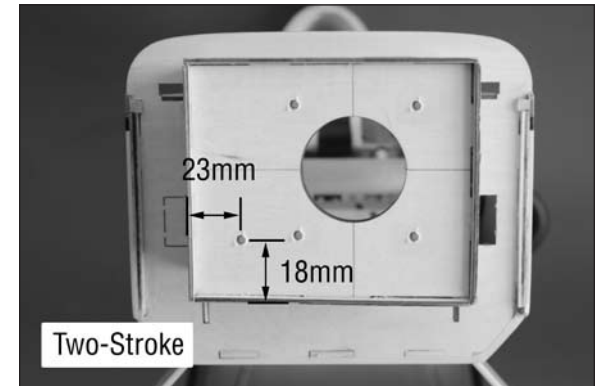

- 5. Locate the plywood tank disk. Use medium CA to glue the disk into the opening in the firewall as shown.

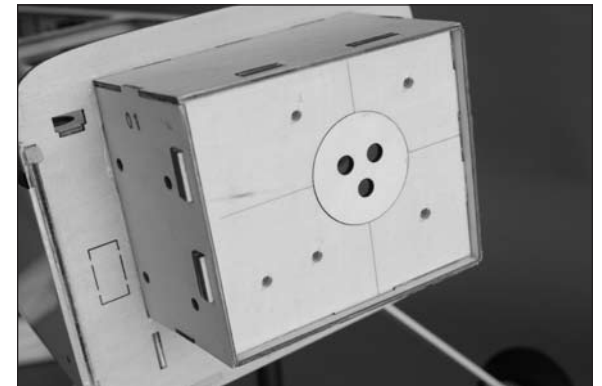

□ 6. Mix 1/2 ounce (15mL) of 30-minute epoxy. Thin the epoxy using isopropyl alcohol so it can be applied to the exposed wood at the front of the fuselage using an epoxy brush. This will fuel-proof the wood to prevent it from soaking up fuel from the engine, which will weaken the wood.



□ 7. Attach the engine mount rails to the firewall using four M4 x 20 socket head screws and four M4 blind nuts. Use a 3mm hex wrench to tighten the hardware, drawing the prongs of the blind nuts into the back side of the firewall.

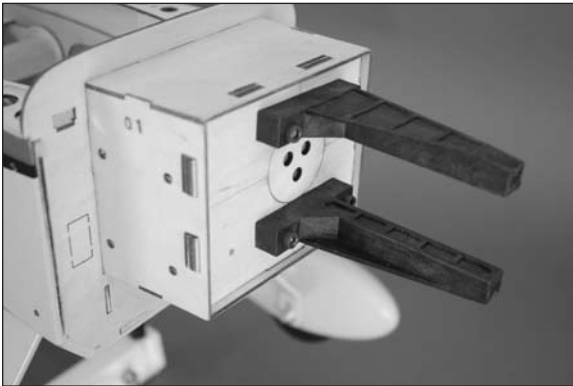

□ 8. Place the engine between the engine mount rails. Position the engine so the face of the drive washer is  $4^{15}/_{16}$ -inch (125mm) forward of the firewall as shown. Use a small clamp to secure the position of the engine at this time.

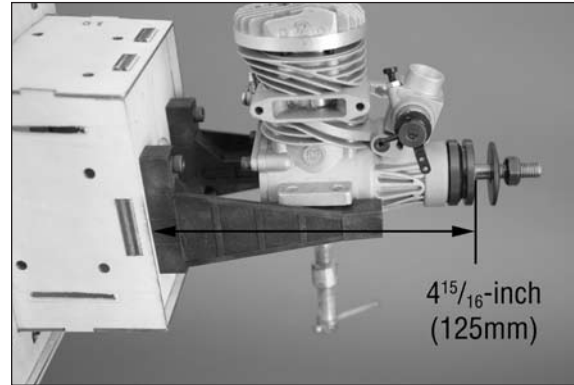

□ 9. Use a pencil to transfer the location for the four engine mounting screws to the engine mount.



□ 10. Remove the engine from the mount. Use a drill and 1/8-inch (3mm) drill bit to drill the holes for the engine mounting bolts.

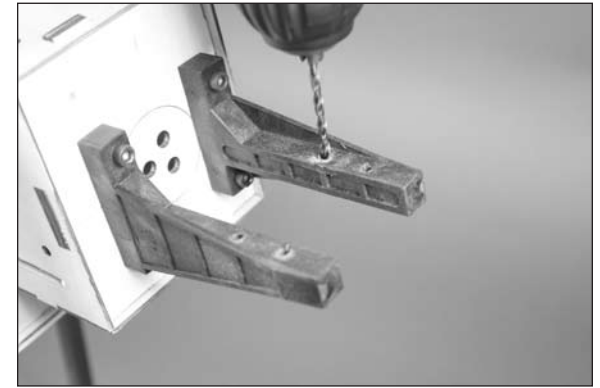

→ We recommend using a drill press to drill the holes in the engine mounting rails to guarantee they are drilled straight.

□ 11. Use medium grit sandpaper to roughen the first 1-inch (25mm) on each end of the throttle pushrod guide tube so the glue will adhere properly.

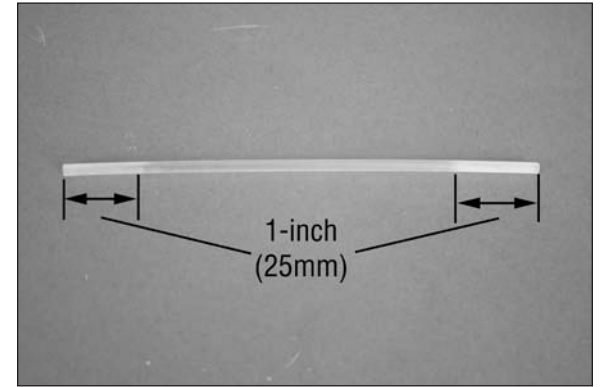

- 12. Slide the tube into the fuselage. Leave 3/4-inch (19mm) of the tube exposed forward of the firewall. Use medium CA to glue the tube to the firewall.

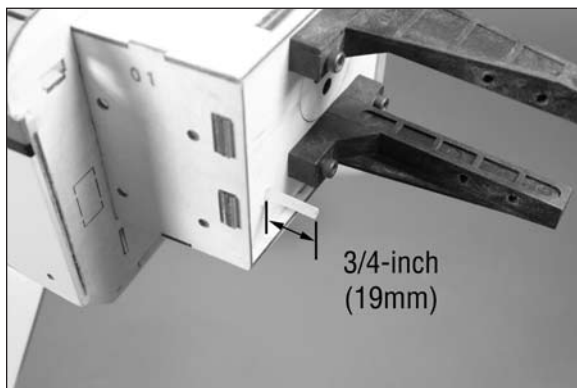

→ When installing the pushrod tube for a four-stroke, position the tube flush with the firewall before gluing it into position.

- 13. Insert the Z-bend of the pushrod into the carburetor arm as shown.

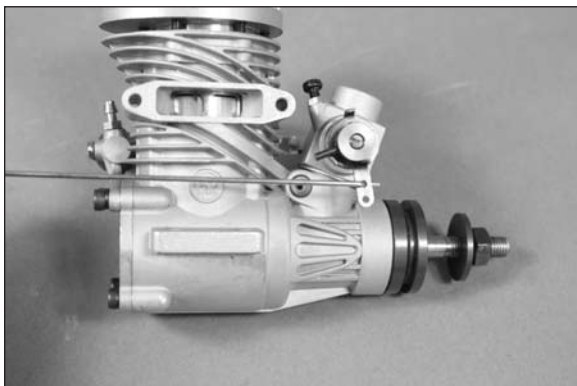

- 14. Reposition the engine between the mounting rails, guiding the pushrod into the pushrod tube. Secure the engine using four M3 x 25 socket head screws, eight M3 washers and four M3 lock nuts. Place the washers between the head of the screw and engine mounting lugs, as well as between the engine mount and M3 lock nuts. Tighten the hardware using a 2.5mm hex wrench and a 5.5mm nut driver.

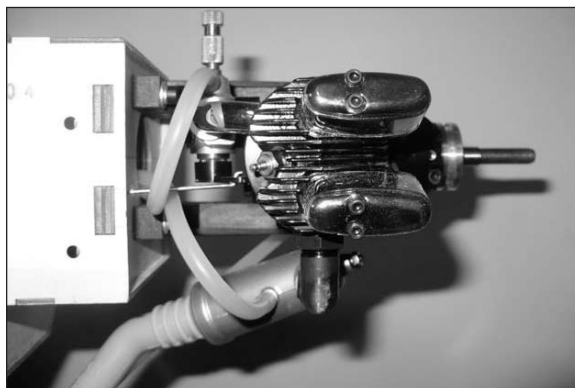
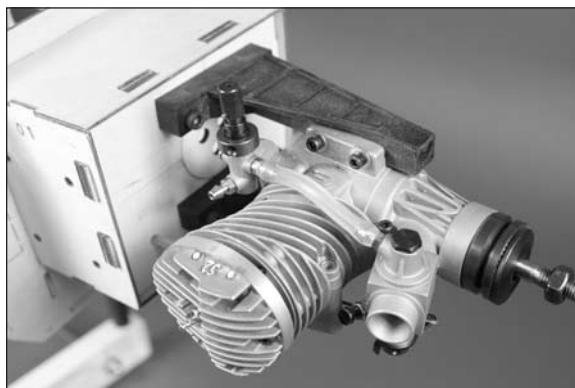

- 15. Use a #1 Phillips screwdriver to thread a servo mounting screw into each of the holes to cut threads in the surrounding wood. Remove the screw before moving to the next step. Apply 2–3 drops of thin CA in each of the holes to harden the surrounding wood. This will harden the threads so the screws do not easily strip the surrounding wood. Remove the servo horn from the servo using a #1 Phillips screwdriver. Install the throttle servo using a #1 Phillips screwdriver and the four mounting screws provided with the servo. The output shaft on the servo will face toward the front of the fuselage. Slide the plywood pushrod support on the pushrod tube.



- 16. Use side cutters to remove the arms from the servo horn. Use a pin vise and 5/64-inch (2mm) drill bit to enlarge the hole 1/2-inch (12mm) from the center of the servo horn. Insert the pushrod connector in the servo horn as shown, making sure it can move freely in the arm. Use the M2 washer and M2 knurled nut to secure the connector to the servo horn. The washers will be located between the nut and arm, as well as between the connector and arm. Make sure to use threadlock or the connector will vibrate loose. Double-check that the connector can move freely in the servo arm.

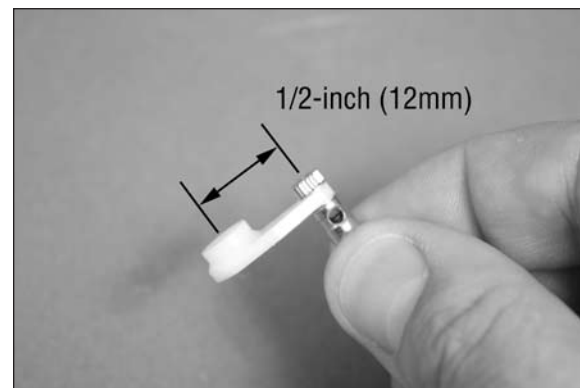

□ 17. Install the servo horn by sliding the connector over the pushrod wire. Center the throttle stick and trim and install the servo horn perpendicular to the servo center line. Move the throttle stick to the closed position and move the carburetor to closed. Use a 2.5mm hex wrench to tighten the screw that secures the throttle pushrod wire. Use threadlock on the screw so it does not vibrate loose. After trimming the plywood pushrod support to align with the servo, use medium CA to glue the pushrod support in position.



## Fuel Tank Assembly and Installation

### Required Parts

Fuselage assembly	380cc fuel tank
Clunk	Rubber glow stopper
M3 x 20 screw	Fuel tank metal plate (2)
100mm surgical tubing	4mm plywood hooks (4)
Rubber bands (4)	
3mm x 50mm aluminum tubing (3)	

□ 1. Locate the items for this section of the manual.

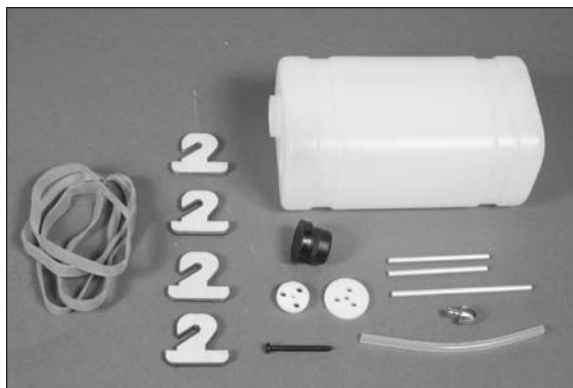

→ *The stopper and silicone tubing included are not compatible with gas engine installations.*

□ 2. Remove the material so two of the three holes in the stopper pass completely through. Use a hobby knife and #11 blade for this procedure.



□ 3. Carefully bend one of the aluminum tubes to a 45-degree angle as shown. Use care not to kink the tubing while bending.

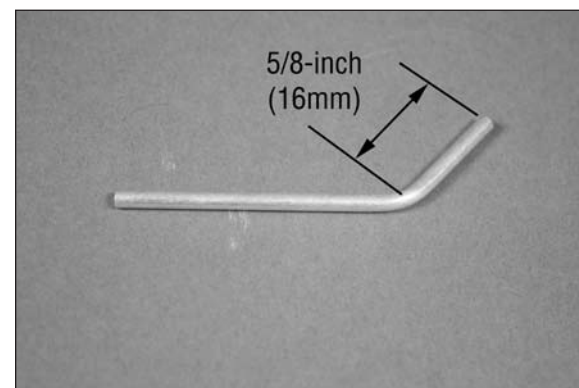

→ *Use a tubing bender to avoid kinking the tubing while bending.*

□ 4. Slide the bent tube in the previous step through the smaller stopper plate. The tube is then inserted in the stopper from the smaller, or back, of the stopper. Leave 5/8-inch (16mm) of the tube forward of the stopper.

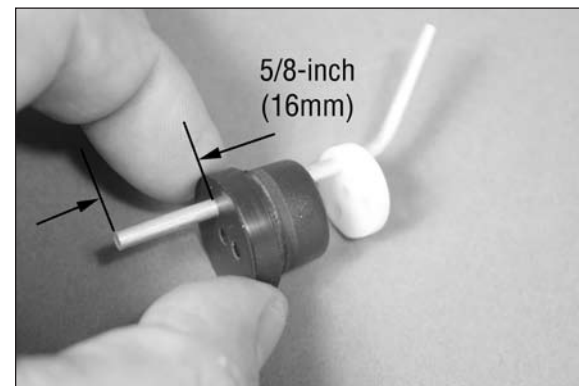

- 5. Slide an aluminum tube through the stopper. Position the front of the tube even with the bent tube as shown.

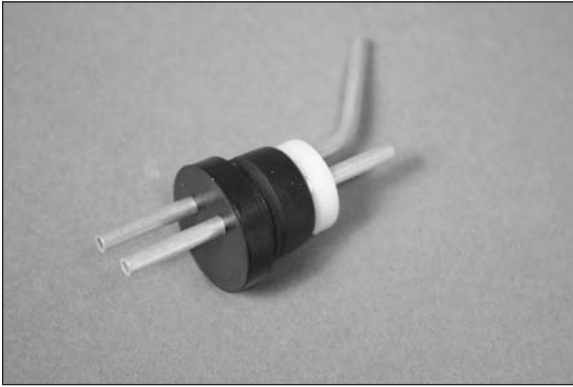

- 6. Slide the larger stopper plate over the tubing at the front. Start the M3 x 20 screw using a #1 Phillips screwdriver. The screw only needs to be in far enough to keep the large stopper plate from falling off. Slide the fuel tubing on the straight piece of aluminum tubing. The clunk will be placed on the opposite end of the fuel tubing.

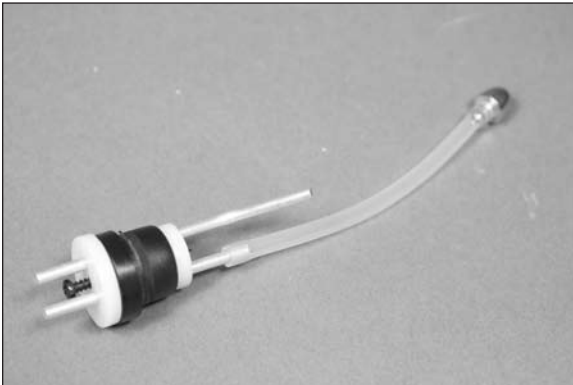

- ➔ *If you are assembling the fuel tank for use with a gas engine, you will need to use solder and a soldering iron to create a small barb for the fuel lines before they are installed. This is necessary as the tubing will need to be wired on to prevent it from sliding loose.*

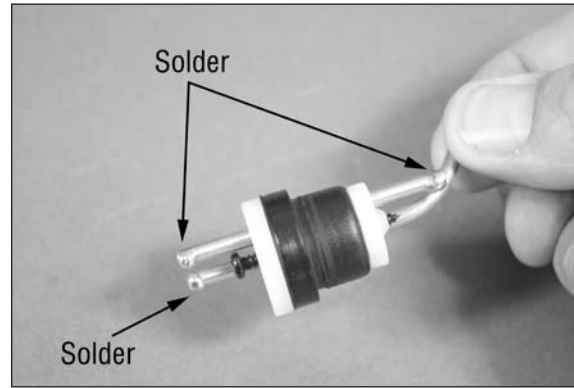

- 7. Insert the stopper assembly into the fuel tank. Make sure the vent line faces the top of the tank as shown.

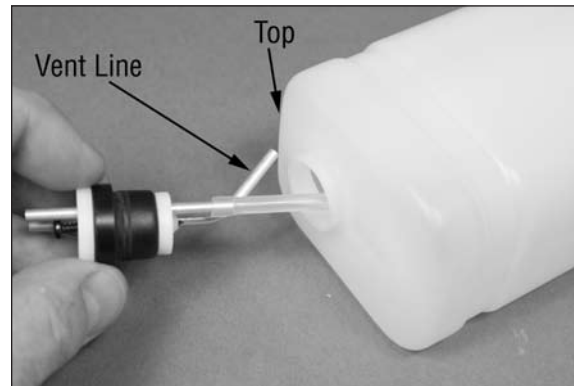

- 8. Use a #1 Phillips screwdriver to tighten the M3 x 20 screw that secures the stopper in the tank. Don't over-tighten the screw as you could damage the fuel tank. It needs to be tight enough to create a seal between the tank and stopper. Slide the fuel tubing on the tubes outside the tank.



- ➔ *We recommend using red and green fuel lines for your model. Slide the red line on the vent line and the green line on the line from the clunk.*

- ➔ *If you will be using a gas engine, secure the fuel line to the tubes so they don't slip off in flight by using a small wiretie or safety wire.*

- 9. Use medium CA to glue the four plywood hooks in the slots inside the fuselage. The hooks are installed by inserting them at an angle through the slots, then rotating them into position.



□ 10. Place the fuel tank into the fuselage, making sure that the top of the fuel tank is facing toward the top of the fuselage. Guide the lines from the tank through the hole in the firewall. Use rubber bands at the front and rear to secure the tank in the fuselage. Loop the rubber band over-and-back to secure the tank.



➔ *If you are installing a gas engine, simply route the vent line to the bottom of the fuselage.*

## Cowl, Propeller and Spinner Installation

### Required Parts

Fuselage assembly	Cowling
Propeller	Muffler
Canopy hatch	M3 black flat washer (4)
Fuel dot (not included)	
Spinner assembly with adapters	
M3 x 12 socket head screw (4)	

□ 1. Locate the items for this section of the manual.



□ 2. Place the canopy hatch on the fuselage. Use card stock and low-tack tape to locate the positions for the cowl mounting screws and the needle valve and any other items that may need to be accessed through the cowl.

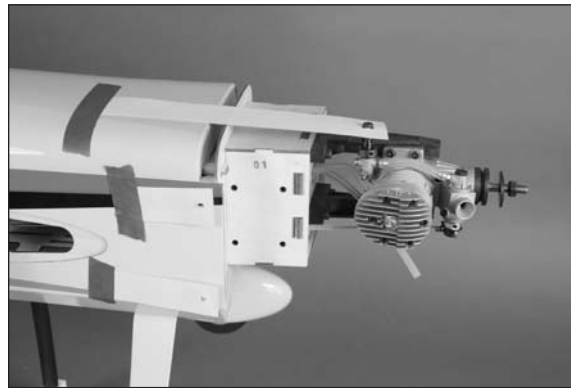

□ 3. Slide the cowl into position, making sure the card stock is on the outside of the cowl. Install the busing(s) in the spinner backplate. Place the spinner backplate and propeller on the engine shaft. Use the engine washer and adapter from the spinner to keep the backplate and propeller in place while positioning the cowl.



□ 4. Position the cowl so the spinner is centered in the opening at the front of the cowl. Leave a gap of 3/32-inch (2mm) between the backplate and cowl so the backplate won't rub on the cowl. Use low-tack tape to secure the cowl to the fuselage.

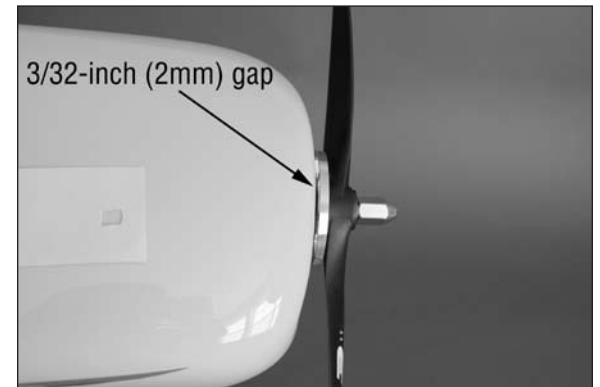

➔ *It may be necessary to remove the needle valve to center the cowl vertically.*

- 5. Once the cowl has been positioned, use a felt-tipped pen to mark the locations for the cowl mounting screws.

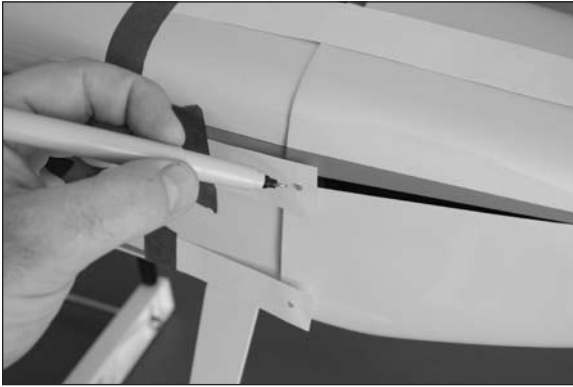

- 6. Remove the cowl from the fuselage. Use a pin vise and 1/8-inch (3mm) drill bit to drill the holes for the cowl mounting screws.



➔ *If you are building your model for electric power, you can skip to step 14 and secure the cowl to the fuselage.*

- 7. Once the mounting holes are drilled, temporarily attach the cowl using four M3 x 12 socket head screws and four M3 washers. Mark the additional locations for the needle valve and any other items that may protrude through the cowl. Don't forget to provide access for the glow plug as well.



- 8. Remove the cowl and make the openings for the needle valve and other items.

- 9. Use a rotary tool and cut-off wheel to shorten the muffler screws so they are 35mm in length.

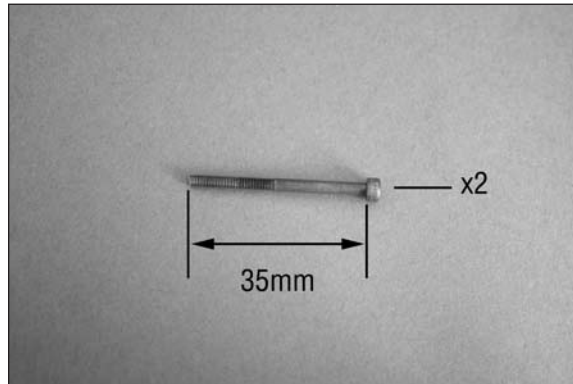

- 10. Attach the muffler to the engine. Connect the fuel line from the vent to the fitting on the muffler. Trim the length of the tubing so it won't interfere with the operation of the engine. Connect the T-fitting from the fuel dot to the carburetor and the line from the fuel tank that connects to the clunk. The final line will fit through the fuel dot mount on the cowling.

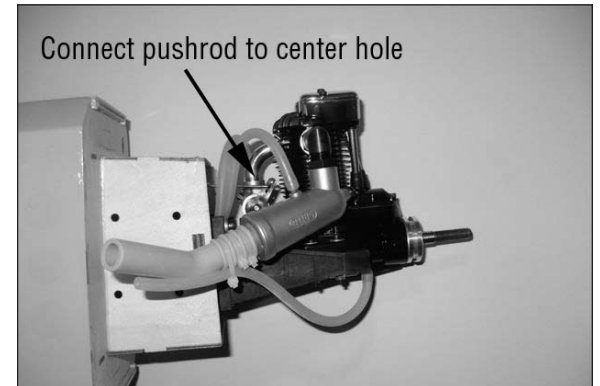
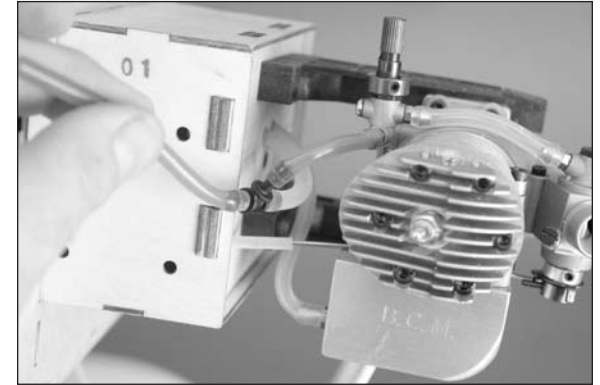

□ 11. Use a drill and 3/8-inch (9.5mm) drill bit to drill the hole in the cowl for the fuel dot. Make sure to locate the hole where the fuel lines will not interfere with the operation of the engine and will not become kinked. Mount the fuel dot to the cowl using the hardware included with the fuel dot.



□ 12. Trim the cowl to fit the muffler. The opening in the bottom of the cowl must be at least twice the size of the opening at the front to allow for air to pass over the engine for cooling. Guide the tubing for the fuel dot through the fitting in the cowl.

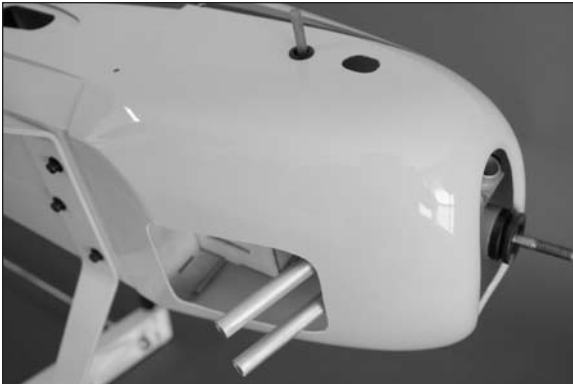

→ To keep the screws from vibrating loose, apply a drop of canopy glue on each screw before threading them into position. You can also use a short 1/8-inch (3mm) piece of fuel tubing between the cowl and washer on each screw.

□ 13. Secure the cowl to the fuselage using four M3 x 12 socket head screws and four M3 washers. Use a 2.5mm hex wrench to tighten the screws. Insert the fuel filler plug into the fuel tubing.



□ 14. Slide the spinner backplate and propeller back on the engine shaft. Tighten the adapter using a 12mm box wrench.



→ Do not use pliers or an adjustable wrench to tighten the propeller adapter. These tools will eventually round the edges of the nut, making it difficult to tighten or remove.

□ 15. Attach the spinner using the bolt supplied. Position the spinner so the openings do not contact the propeller. Use a 5/32-inch hex wrench to tighten the bolt.



→ Make sure the propeller is centered in the openings so the spinner does not rub against the prop blades, which could potentially cause them to fail.



## Optional Side Force Generator and Pilot Installation

### Required Parts

- Wing panel (right and left)
- M3 washer (4)
- Side force generator (2)
- Pilot (not included)
- M3 x 16 socket head cap screw (4)

### SFG Technology™ : Hangar 9's innovative Side Force Generators

□□ 1. Use a covering iron to remove any wrinkles in the covering of the side force generator. Ensure the side force generator lays flat during this process.

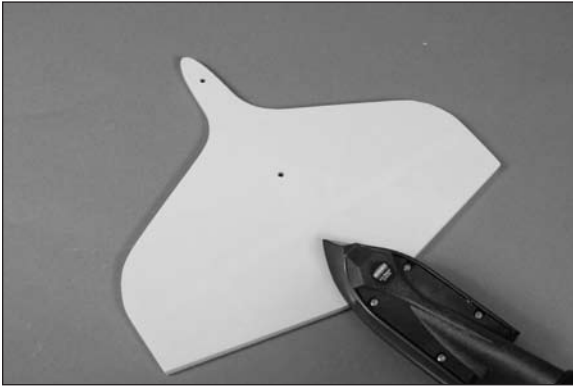

□□ 2. Use a hobby knife and #11 blade to remove the covering to expose the two blind nuts at the wing tip.

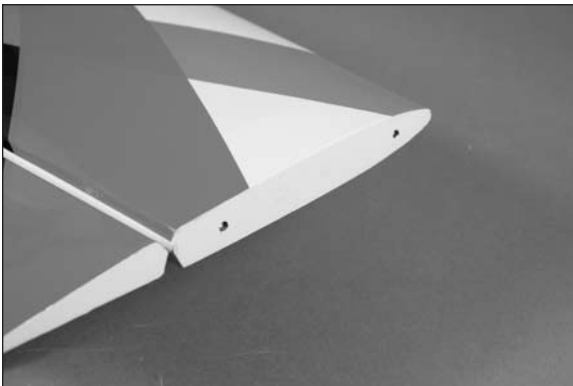

□□ 3. The side force generator is held in position using two M3 x 16 socket head cap screws and two M3 washers. Use a 2.5mm hex wrench to tighten the screws. Use threadlock on the screws to prevent them from vibrating loose.

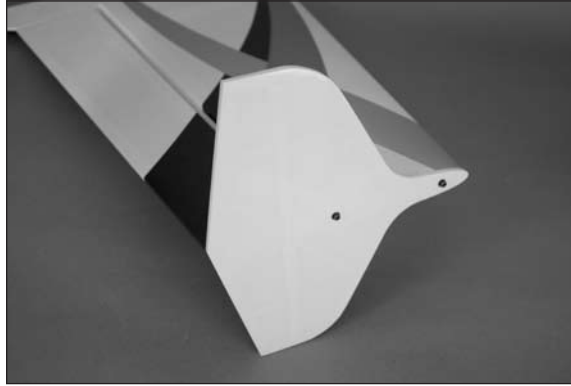

□□ 4. Repeat step 1 through 3 to install the remaining side force generator on the opposite wing panel.

□□ 5. Install the pilot in the cockpit using a brace under the pilot. Use medium CA to glue the pilot in the cockpit.



## Decal Installation

### Required Parts

Fuselage assembly      Wing assembly

□ 1. Apply the decals to your model using the photos located in this section of the manual and the box art from your model. Use a spray bottle and a drop of dish washing liquid sprayed in the location of the decal to allow repositioning. Use a paper towel as a squeegee to remove excess water from under the decal. Allow the model to rest overnight so the remaining water can evaporate.



## Center of Gravity

### Required Parts

Assembled wing      Assembled fuselage  
Nylon wing bolt (2)

An important part of preparing the aircraft for flight is properly balancing the model.

**⚠ CAUTION: Do not inadvertently skip this step!**

- 1. Attach the wing panels to the fuselage using the two nylon wing bolts. Make sure to connect the leads from the aileron to the appropriate leads from the receiver. Make sure the leads are not exposed outside the fuselage before tightening the wing bolts.
- 2. The recommended Center of Gravity (CG) location for your model is  $4\frac{1}{2}$  inches (114mm) back from the leading edge of the wing against the fuselage as shown. Mark the location of the CG on the top of the wing with a felt-tipped pen.

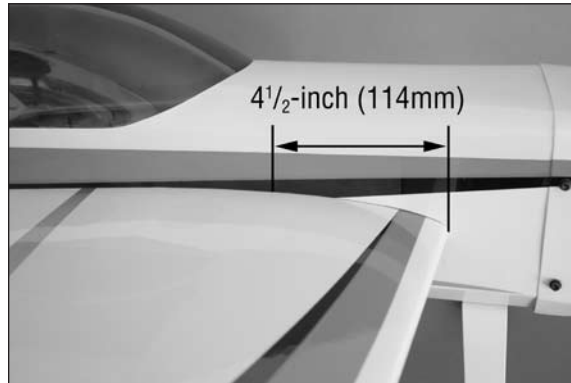

□ 3. When balancing your model, make sure it is assembled and ready for flight. Support the plane inverted at the marks made on the wing with your fingers or a commercially available balancing stand. This is the correct balance point for your model.

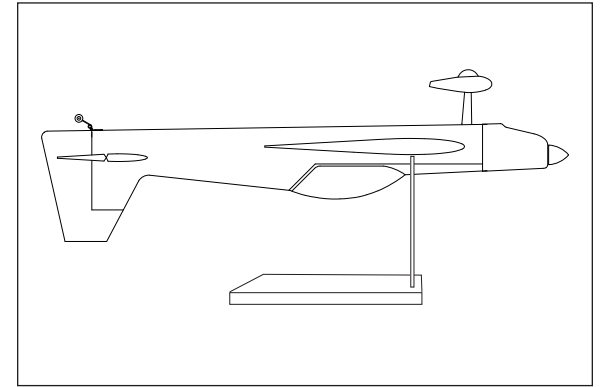

□ 4. You should find the CG to be very close with the components installed as shown in this manual. If the nose of your aircraft hangs low, add weight to the rear of the aircraft. If the tail hangs low, add weight to the nose of the aircraft. Self-stick weights (HAN3626) are available at your local hobby store and work well for this purpose.

After the first flights, the CG position can be adjusted for your personal preference. We have found the balance anywhere between  $4\frac{3}{8}$ – $4\frac{3}{4}$ -inch (111mm–120mm) while maintaining great flying characteristics.

## Control Throws

- 1. Turn on the transmitter and receiver of your model. Check the movement of the rudder using the transmitter. When the stick is moved to the right, the rudder should also move right. Reverse the direction of the servo at the transmitter if necessary.
- 2. Check the movement of the elevator with the radio system. Moving the elevator stick toward the bottom of the transmitter will make the airplane elevator move up.
- 3. Check the movement of the ailerons with the radio system. Moving the aileron stick to the right will make the right aileron move up and the left aileron move down.
- 4. Use a ruler to adjust the throw of the elevator, ailerons and rudder.

### Aileron:

#### High Rate:

Up:	2 <sup>11</sup> / <sub>16</sub> -inches	68mm
Down:	2 <sup>11</sup> / <sub>16</sub> -inches	68mm

#### Low Rate:

Up:	1 <sup>1</sup> / <sub>8</sub> -inches	29mm
Down:	1 <sup>1</sup> / <sub>8</sub> -inches	29mm

### Elevator:

#### High Rate:

Up:	3-inches	76mm
Down:	3-inches	76mm

#### Low Rate:

Up:	1 <sup>3</sup> / <sub>16</sub> -inches	30mm
Down:	1 <sup>3</sup> / <sub>16</sub> -inches	30mm

### Rudder:

#### High Rate:

Right:	2 <sup>9</sup> / <sub>16</sub> -inches	98mm
Left:	2 <sup>9</sup> / <sub>16</sub> -inches	98mm

#### Low Rate:

Right:	1 <sup>7</sup> / <sub>8</sub> -inches	65mm
Left:	1 <sup>7</sup> / <sub>8</sub> -inches	65mm

These are general guidelines measured from our own flight tests. You can experiment with higher rates to match your preferred style of flying.

→ *Travel Adjust and Sub-Trims are not listed and should be adjusted according to each individual model and preference. Always install the control horns 90 degrees to the servo centerline. Use sub-trim as a last resort to center the servos.*

→ *We highly recommend re-binding the radio system once all the control throws are set. This will keep the servos from moving to their endpoints until the transmitter and receiver connect.*

## Rates and Expos

Use Expo to soften the feel of the model. On high 3D rates, use quite a bit of expo. The goal on 3D rates is to get the model to feel the same around neutral as it does on low rates.

Use low rate settings for all flying except for 3D aerobatics. For precision flying or general sport hotdogging, the low rate throws are perfect, even for snap rolls. The only exception is rudder rates. Use 3D rudder rate when doing stall turns and rolling circles, since more rudder is better for these.

When doing 3D aerobatics, flip to 3D rates just before the maneuver. As soon as the maneuver is done, flip back down to low rate to avoid over-controlling the model.

## Preflight

### Check Your Radio

Before going to the field, ensure your batteries are fully charged per your radio's instructions. Charge the transmitter and motor battery for your airplane. Use the recommended charger supplied with your particular radio system, following the instructions provided with the radio. In most cases, the radio should be charged the night before going out flying.

Prior to each flying session, make sure to range check your radio. See your radio manual for the recommended range and instructions for your radio system. Each radio manufacturer specifies different procedures for their radio systems. Next, run the motor. With the model securely anchored, check the range again. The range test should not be significantly affected. If it is, don't attempt to fly! Have your radio equipment checked out by the manufacturer.

Double-check that all controls (aileron, elevator, rudder and throttle) move in the correct direction.

Check the radio installation and make sure all the control surfaces are moving correctly (i.e., the correct direction and with the recommended throws).

Check all the control horns, servo horns, and clevises to make sure they are secure and in good condition.

### Range Test Your Radio

Before each flying session, and especially with a new model, it is important to perform a range check. It is helpful to have another person available to assist during the range check. If you are using a Spektrum transmitter, please refer to your transmitter's manual for detailed instructions on the range check process.

## ***Safety Do's and Don'ts for Pilots***

- Consult local laws and ordinances before choosing a location to fly your aircraft.
- Check all control surfaces prior to each takeoff.
- Do not fly your model near spectators, parking areas or any other area that could result in injury to people or damage of property.
- Do not fly during adverse weather conditions. Poor visibility can cause disorientation and loss of control of your aircraft. Strong winds can cause similar problems.
- Do not take chances. If at any time during flight you observe any erratic or abnormal operation, land immediately and do not resume flight until the cause of the problem has been ascertained and corrected. Safety can never be taken lightly.
- Do not fly near power lines.

## ***Daily Flight Checks***

- 1. Check the battery voltage of the transmitter battery. Do not fly below the manufacturer's recommended voltage. To do so can crash your aircraft.

**When you check these batteries, ensure you have the polarities correct on your expanded scale voltmeter.**

- 2. Check all hardware (linkages, screws, nuts, and bolts) prior to each day's flight. Ensure that binding does not occur and that all parts are properly secured.
- 3. Ensure all surfaces are moving in the proper manner.
- 4. Perform a ground range check before each day's flying session.
- 5. Prior to starting your aircraft, turn off your transmitter, then turn it back on. Do this each time you start your aircraft. If any critical switches are on without your knowledge, the transmitter alarm will sound a warning.
- 6. Check that all trim levers are in the proper location.
- 7. All servo pigtails and switch harness plugs should be secured in the receiver. Make sure the switch harness moves freely in both directions.

## ***Limited Warranty***

### ***WHAT THIS WARRANTY COVERS***

Horizon Hobby, Inc. ("Horizon") warrants to the original purchaser that the product purchased (the "Product") will be free from defects in materials and workmanship at the date of purchase.

### ***WHAT IS NOT COVERED***

This warranty is not transferable and does not cover (i) cosmetic damage, (ii) damage due to acts of God, accident, misuse, abuse, negligence, commercial use, or due to improper use, installation, operation or maintenance, (iii) modification of or to any part of the Product, (iv) attempted service by anyone other than a Horizon Hobby authorized service center, or (v) Products not purchased from an authorized Horizon dealer.

OTHER THAN THE EXPRESS WARRANTY ABOVE, HORIZON MAKES NO OTHER WARRANTY OR REPRESENTATION, AND HEREBY DISCLAIMS ANY AND ALL IMPLIED WARRANTIES, INCLUDING, WITHOUT LIMITATION, THE IMPLIED WARRANTIES OF NON-INFRINGEMENT, MERCHANTABILITY AND FITNESS FOR A PARTICULAR PURPOSE. THE PURCHASER ACKNOWLEDGES THAT THEY ALONE HAVE DETERMINED THAT THE PRODUCT WILL SUITABLY MEET THE REQUIREMENTS OF THE PURCHASER'S INTENDED USE.

### ***PURCHASER'S REMEDY***

Horizon's sole obligation and purchaser's sole and exclusive remedy shall be that Horizon will, at its option, either (i) service, or (ii) replace, any Product determined by Horizon to be defective. Horizon reserves the right to inspect any and all Product(s) involved in a warranty claim. Service or replacement decisions are at the sole discretion of Horizon. Proof of purchase is required for all warranty claims. SERVICE OR REPLACEMENT AS PROVIDED UNDER THIS WARRANTY IS THE PURCHASER'S SOLE AND EXCLUSIVE REMEDY.

## ***LIMITATION OF LIABILITY***

HORIZON SHALL NOT BE LIABLE FOR SPECIAL, INDIRECT, INCIDENTAL OR CONSEQUENTIAL DAMAGES, LOSS OF PROFITS OR PRODUCTION OR COMMERCIAL LOSS IN ANY WAY, REGARDLESS OF WHETHER SUCH CLAIM IS BASED IN CONTRACT, WARRANTY, TORT, NEGLIGENCE, STRICT LIABILITY OR ANY OTHER THEORY OF LIABILITY, EVEN IF HORIZON HAS BEEN ADVISED OF THE POSSIBILITY OF SUCH DAMAGES. Further, in no event shall the liability of Horizon exceed the individual price of the Product on which liability is asserted. As Horizon has no control over use, setup, final assembly, modification or misuse, no liability shall be assumed nor accepted for any resulting damage or injury. By the act of use, setup or assembly, the user accepts all resulting liability. If you as the purchaser or user are not prepared to accept the liability associated with the use of the Product, purchaser is advised to return the Product immediately in new and unused condition to the place of purchase.

### ***LAW***

These terms are governed by Illinois law (without regard to conflict of law principals). This warranty gives you specific legal rights, and you may also have other rights which vary from state to state. Horizon reserves the right to change or modify this warranty at any time without notice.

## Warranty Services

### QUESTIONS, ASSISTANCE, AND SERVICES

Your local hobby store and/or place of purchase cannot provide warranty support or service. Once assembly, setup or use of the Product has been started, you must contact Horizon directly. This will enable Horizon to better answer your questions and service you in the event that you may need any assistance. For questions or assistance, please direct your email to [productsupport@horizonhobby.com](mailto:productsupport@horizonhobby.com), or call 877.504.0233 toll free to speak to a Product Support representative. You may also find information on our website at [www.horizonhobby.com](http://www.horizonhobby.com).

### INSPECTION OR SERVICES

If this Product needs to be inspected or serviced, please use the Horizon Online Service Request submission process found on our website or call Horizon to obtain a Return Merchandise Authorization (RMA) number. Pack the Product securely using a shipping carton. Please note that original boxes may be included, but are not designed to withstand the rigors of shipping without additional protection. Ship via a carrier that provides tracking and insurance for lost or damaged parcels, as Horizon is not responsible for merchandise until it arrives and is accepted at our facility. An Online Service Request is available at <http://www.horizonhobby.com> under the Support tab. If you do not have internet access, please contact Horizon Product Support to obtain a RMA number along with instructions for submitting your product for service. When calling Horizon, you will be asked to provide your complete name, street address, email address and phone number where you can be reached during business hours. When sending product into Horizon, please include your RMA number, a list of the included items, and a brief summary of the problem. A copy of your original sales receipt must be included for warranty consideration. Be sure your name, address, and RMA number are clearly written on the outside of the shipping carton.

**Notice: Do not ship LiPo batteries to Horizon. If you have any issue with a LiPo battery, please contact the appropriate Horizon Product Support office.**

### WARRANTY REQUIREMENTS

**For Warranty consideration, you must include your original sales receipt verifying the proof-of-purchase date.** Provided warranty conditions have been met, your Product will be serviced or replaced free of charge. Service or replacement decisions are at the sole discretion of Horizon.

### NON-WARRANTY SERVICE

**Should your service not be covered by warranty service will be completed and payment will be required without notification or estimate of the expense unless the expense exceeds 50% of the retail purchase cost.** By submitting the item for service you are agreeing to payment of the service without notification. Service estimates are available upon request. You must include this request with your item submitted for service. Non-warranty service estimates will be billed a minimum of ½ hour of labor. In addition you will be billed for return freight. Horizon accepts money orders and cashiers checks, as well as Visa, MasterCard, American Express, and Discover cards. By submitting any item to Horizon for service, you are agreeing to Horizon's Terms and Conditions found on our website <http://www.horizonhobby.com/Service/Request>.

### UNITED STATES

*(Electronics and engines)*

Horizon Service Center  
4105 Fieldstone Rd  
Champaign, Illinois  
61822 USA

[productsupport@horizonhobby.com](mailto:productsupport@horizonhobby.com)  
877-504-0233  
Online Repair Request visit:  
[www.horizonhobby.com/service](http://www.horizonhobby.com/service)

*(All other products)*

Horizon Product Support  
4105 Fieldstone Rd  
Champaign, Illinois  
61822 USA  
[productsupport@horizonhobby.com](mailto:productsupport@horizonhobby.com)  
877-504-0233

### UNITED KINGDOM

Horizon Hobby Limited  
Units 1-4 Ployters Rd  
Staple Tye  
Harlow, Essex  
CM18 7NS  
United Kingdom  
[sales@horizonhobby.co.uk](mailto:sales@horizonhobby.co.uk)  
+44 (0) 1279 641 097

### GERMANY

Horizon Technischer Service  
Hamburger Str. 10  
25335 Elmshorn  
Germany  
[service@horizonhobby.de](mailto:service@horizonhobby.de)  
+49 4121 46199 66

### FRANCE

Horizon Hobby SAS  
14 Rue Gustave Eiffel  
Zone d'Activité du Réveil Matin  
91230 Montgeron  
+33 (0) 1 60 47 44 70

## Compliance Information for the European Union



### INSTRUCTIONS FOR DISPOSAL OF WEEE BY USERS IN THE EUROPEAN UNION

This product must not be disposed of with other waste. Instead, it is the user's responsibility to dispose of their waste equipment by handing it over to a designated collection point for the recycling of waste electrical and electronic equipment. The separate collection and recycling of your waste equipment at the time of disposal will help to conserve natural resources and ensure that it is recycled in a manner that protects human health and the environment. For more information about where you can drop off your waste equipment for recycling, please contact your local city office, your household waste disposal service or where you purchased the product.

# Academy of Model Aeronautics National Model Aircraft Safety Code

Effective January 1, 2011

## A. GENERAL

A model aircraft is a non-human-carrying aircraft capable of sustained flight in the atmosphere. It may not exceed limitations of this code and is intended exclusively for sport, recreation and/or competition. All model flights must be conducted in accordance with this safety code and any additional rules specific to the flying site.

1. Model aircraft will not be flown:
  - (a) In a careless or reckless manner.
  - (b) At a location where model aircraft activities are prohibited.
2. Model aircraft pilots will:
  - (a) Yield the right of way to all man carrying aircraft.
  - (b) See and avoid all aircraft and a spotter must be used when appropriate. (AMA Document #540-D-See and Avoid Guidance.)
  - (c) Not fly higher than approximately 400 feet above ground level within three (3) miles of an airport, without notifying the airport operator.
  - (d) Not interfere with operations and traffic patterns at any airport, heliport or seaplane base except where there is a mixed use agreement.
  - (e) Not exceed a takeoff weight, including fuel, of 55 pounds unless in compliance with the AMA Large Model Aircraft program. (AMA Document 520-A)
  - (f) Ensure the aircraft is identified with the name and address or AMA number of the owner on the inside or affixed to the outside of the model aircraft. (This does not apply to model aircraft flown indoors).
  - (g) Not operate aircraft with metal-blade propellers or with gaseous boosts except for helicopters operated under the provisions of AMA Document #555.
  - (h) Not operate model aircraft while under the influence of alcohol or while using any drug which could adversely affect the pilot's ability to safely control the model.
  - (i) Not operate model aircraft carrying pyrotechnic devices which explode or burn, or any device which propels a projectile or drops any object that creates a hazard to persons or property.

Exceptions:

- Free Flight fuses or devices that burn producing smoke and are securely attached to the model aircraft during flight.

- Rocket motors (using solid propellant) up to a G-series size may be used provided they remain attached to the model during flight. Model rockets may be flown in accordance with the National Model Rocketry Safety Code but may not be launched from model aircraft.
- Officially designated AMA Air Show Teams (AST) are authorized to use devices and practices as defined within the Team AMA Program Document (AMA Document #718).
  - (j) Not operate a turbine-powered aircraft, unless in compliance with the AMA turbine regulations. (AMA Document #510-A).
- 3. Model aircraft will not be flown in AMA sanctioned events, air shows or model demonstrations unless:
  - (a) The aircraft, control system and pilot skills have successfully demonstrated all maneuvers intended or anticipated prior to the specific event.
  - (b) An inexperienced pilot is assisted by an experienced pilot.
- 4. When and where required by rule, helmets must be properly worn and fastened. They must be OSHA, DOT, ANSI, SNELL or NOCSAE approved or comply with comparable standards.

## B. RADIO CONTROL (RC)

1. All pilots shall avoid flying directly over unprotected people, vessels, vehicles or structures and shall avoid endangerment of life and property of others.
2. A successful radio equipment ground-range check in accordance with manufacturer's recommendations will be completed before the first flight of a new or repaired model aircraft.
3. At all flying sites a safety line(s) must be established in front of which all flying takes place (AMA Document #706-Recommended Field Layout):
  - (a) Only personnel associated with flying the model aircraft are allowed at or in front of the safety line.
  - (b) At air shows or demonstrations, a straight safety line must be established.
  - (c) An area away from the safety line must be maintained for spectators.
  - (d) Intentional flying behind the safety line is prohibited.
4. RC model aircraft must use the radio-control frequencies currently allowed by the Federal Communications Commission (FCC). Only individuals properly licensed by the FCC are authorized to operate equipment on Amateur Band frequencies.
5. RC model aircraft will not operate within three (3) miles of any pre-existing flying site without a frequency-management agreement (AMA Documents #922- Testing for RF Interference; #923- Frequency Management Agreement)

6. With the exception of events flown under official AMA Competition Regulations, excluding takeoff and landing, no powered model may be flown outdoors closer than 25 feet to any individual, except for the pilot and the pilot's helper(s) located at the flight line.
7. Under no circumstances may a pilot or other person touch a model aircraft in flight while it is still under power, except to divert it from striking an individual. This does not apply to model aircraft flown indoors.
8. RC night flying requires a lighting system providing the pilot with a clear view of the model's attitude and orientation at all times.
9. The pilot of a RC model aircraft shall:
  - (a) Maintain control during the entire flight, maintaining visual contact without enhancement other than by corrective lenses prescribed for the pilot.
  - (b) Fly using the assistance of a camera or First-Person View (FPV) only in accordance with the procedures outlined in AMA Document #550.

## C. FREE FLIGHT

1. Must be at least 100 feet downwind of spectators and automobile parking when the model aircraft is launched.
2. Launch area must be clear of all individuals except mechanics, officials, and other fliers.
3. An effective device will be used to extinguish any fuse on the model aircraft after the fuse has completed its function.

## D. CONTROL LINE

1. The complete control system (including the safety thong where applicable) must have an inspection and pull test prior to flying.
2. The pull test will be in accordance with the current Competition Regulations for the applicable model aircraft category.
3. Model aircraft not fitting a specific category shall use those pull-test requirements as indicated for Control Line Precision Aerobatics.
4. The flying area must be clear of all utility wires or poles and a model aircraft will not be flown closer than 50 feet to any above-ground electric utility lines.
5. The flying area must be clear of all nonessential participants and spectators before the engine is started.





© 2011 Horizon Hobby, Inc.  
horizonhobby.com  
Hangar9.com

Hangar 9, Evolution, JR, DSM2, DSMX, Side Force Generators, PowerPro and the Horizon Hobby logo are trademarks or registered trademarks of Horizon Hobby, Inc.

The Spektrum trademark is used with permission of Bachmann Industries, Inc.

Saito is a trademark of Saito Seisakusho Co. Ltd, Japan.

All other trademarks, service marks and logos are the property of their respective owners.