



INSTRUCTION MANUAL



Specification:

- Length/530mm
- Width/420mm
- Height/215mm
- Ground Clearance/75mm
- Wheelbase/370~375mm
- Track/F/R:330~360mm
- Gear Ratio/C:58/13T, F/R 38/11T
- Weight/4100g



1/8 Scale Radio Controlled Gas Powered Off Road 4WD Racing Truggy

INDEX

Required Equipment for Operation.....	3
Before You Start.....	4
Operation Guide.....	5
Step By Step from A to Z.....	6-16
Assembly Steps.....	17-24
Troubleshooting Guide.....	25
Exploded View with Key Numbers.....	26-27
Set-up Sheet/Blank Set-up Sheet.....	28-29
XUT Key No. List.....	30-32
XUT Spare Part List.....	32-34
Warranty.....	35
XUT Option Parts.....	36
GS Racing Latest News.....	37-39
Company Info.....	40



This radio controlled racing car is not a toy!
This high-performance R/C model is recommended for ages 14 and older.

Contents



Congratulations on your purchase of the new GS Racing XUT RTR 1/8 scale off-road truggy.

Please read this manual thoroughly, before you attempt to start or drive your XUT RTR. This manual contains step-by-step instructions to help you complete, prepare for startup, and fine-tune your truggy. Updates, setups, and product news will be posted on our website, so check often.

As always, if you should ever have any questions or need help with your XUT RTR, please feel free to contact our official GS Racing dealers and distributors, as they will be glad to help you. You may also contact us at any time for the most up to date information and support.

Good luck and good racing!

- GS RACING -



Required Equipment for Operation

1. Tools Required for Building and Maintenance:

- Precision Ruler or Caliper



- Hobby Knife

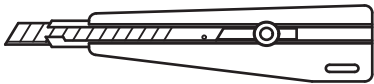

- Needle Nose Pliers

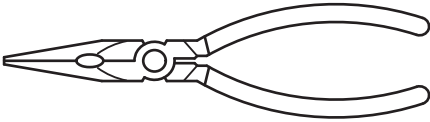

- Phillips Screwdriver (#0,#1,#2)

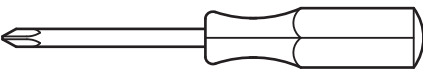

- Flathead Screwdriver

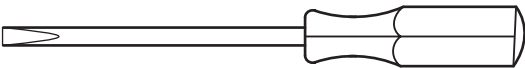

- Hobby Scissors

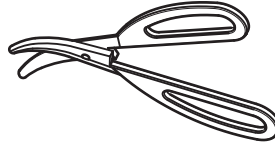

- Wire Cutters

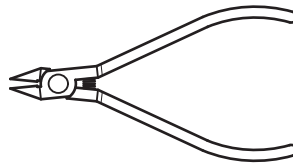

- Thread Locking Compound

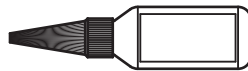

- CA Glue and Rubber Cement



- Silicone Type of Grease

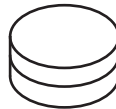

Tools Included:

- Hex Wrench

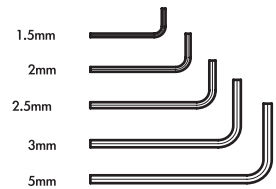

- Cross Wrench

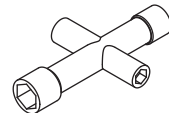
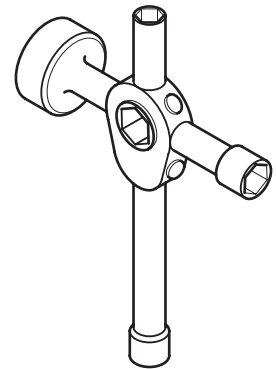

WARNING!

Do not use a power screwdriver to install screws into nylon or plastic materials. The fast rotation speed can heat up the screws being installed. They can then break the molded parts or strip the threads during installation.

2. Additional Items Required:

- 8 AA size Batteries (For Transmitter)
- 4 AA size Batteries (For Receiver)
- 1AA size Battery (For Igniter)
- One 6-Cell 7.2-Volt Battery Packs for Drill Starter Unit (Drill Starter Kits only)
- Glow Fuel (20-30%)

3. Suggested Items:

- Ni-Cd/Ni-MH Battery Pack (5-Cell Hump Type)
- High Speed/High Torque Servos
- Differential, Shock, Air Filter Oils and Model Grease

Before You Start

1. If you find any problems regarding parts or packaging, please contact your local dealer or your GS Racing Distributor. If you ever have any questions, please feel free to contact your GS Racing distributor.
2. We are constantly updating parts to improve our products. These changes, if any, will be noted in supplementary sheets located in a parts bag or inside the box. Check the box before you start and each bag as it is opened. When a supplement is found, attach it to the appropriate section of the manual.
3. The circled numbers in the drawings are key numbers. These numbers are to be used to quickly find the part name and item (part) number in the back of the manual.
4. When we refer to left and right sides, we are referring to the driver's point of view from inside the truggy.
5. Experienced racers pay special attention to small details. Two such details are making sure all parts are bind-free and making sure all screws are clean of manufacturing oil. As you build the car you will be asked to make sure parts "rotate freely" or "move freely". This is very important and should not be overlooked. Nearly all the screws supplied with this and most other r/c cars have a very thin coat of oil on them. Often, this oil can cause a screw to come loose prematurely. Take time to wipe clean all screws. You may also use a lighter or other flame (use caution, minors use adult supervision) to burn off this oil.



Operation Guide

Safety Precautions

This is a high performance radio controlled model which needs to be operated with caution and common sense. Failure to operate your model in a safe and responsible manner could result in personal injury and/or property damage. It is your responsibility to read and follow all safety precautions. The XUT RTR is not intended for children under the age of 14 without adult supervision. GS Racing shall not be held liable for any loss or damages, whether direct, indirect, act of nature, arising from the abuse or misuse of this product or any other product required while operating this model.

- Fuel can be dangerous if improperly handled. Follow all of the manufacturer's suggestions.
- Always keep fuel in a cool area and never use near flame, sparks, or while smoking.
- Keep fuel, and all other flammables, out of the reach of children.
- Always run your model in a well ventilated area outdoors. Never run your model indoors.
- All parts of the engine and exhaust can become extremely hot during, and after use. Be careful not to touch these parts especially when refueling, or making repairs.
- This model creates high levels of noise. Use ear protection if you find noise objectionable.
- This model is controlled by a radio frequency that is vulnerable to interference from many outside sources. This interference can cause a loss of control so it is necessary to operate this model in an open area to avoid personal, or property damage. Always ensure no one is using your frequency before turning on your radio or model.
- Keep all the product included in the package out of reach of children.
- This model contains many fast rotating parts. Never touch them during operation.
- Read, understand, and follow the instruction included with your radio gear.
- Never operate your model near people or property. The speed of this model has the potential for injury and or damage to people and or property.
- Always use original GS Racing and GS approved spare and option parts.
- Never point the radio antenna at a person's face.
- Always ensure the truck is in proper working condition before use.
- Always exercise caution when using any and all tools.

Never use anything other than model car fuel.

Never operate the model with a low battery. If the response becomes slow, stop immediately and replace batteries. Always use correct batteries and never reverse polarity. Follow manufacturer's instructions for proper battery disposal.

Never run the model without a clean and properly installed air cleaner.

Never run the model lean or allow the engine to overheat.



Step By Step from A to Z

Follow these steps to finish, prepare, break in, and run your XUT RTR. Performing the following steps will ensure your XUT RTR operates properly. If you are new to R/C or have limited Nitro experience, these instructions should help you get running quickly and with minimal problems.

A: Remove the XUT RTR and all other contents from the box. Identify and familiarize yourself with the following items:

- 1) XUT RTR with body (body and wheels included in your kit may differ from those shown in photos). Remove the truggy from the packaging board.



- 2) Antenna Tube. This tube houses the receiver antenna wire. You will install this antenna tube shortly.



- 3) Shock Spring Spacers. These spacers fit onto the shocks and are used to raise (or lower) the height of the car (ride height). You may need to install these onto the shock shortly.



Step By Step from A to Z

- 5) Tools. Your XUT RTR includes a set of hex wrenches and a 4 way cross wrench. You will use these tools for the various adjustments and maintenance of your XUT RTR.



- 6) Fuel Bottle. The fuel bottle is used to transfer fuel from your fuel container to the fuel tank in your truggy.



- 7) Window Sticker Sheet. These stickers will be applied shortly. XUT RTR Sticker Sheet. You may apply these to the body shortly.



- 8) Glow Igniter. The glow igniter attaches to the glow plug during engine start up. Inside the igniter is a gold spring. Unscrew the end cap of the igniter, locate the spring now and set aside along with igniter.



Step By Step from A to Z

- 10) Radio Control with antenna (control included in your kit may differ from that shown in photo). The radio control is used to drive the truggy and control the various functions (brake, etc.). The radio control unit also contains several knobs and switches, which are used to adjust the servo units in the truggy.



- 11) Power Start Unit with driveshaft (drill start kits only). The Power Start is a hand held unit which is used to start the engine. The shaft is inserted into the coupler in the rear of the engine and when powered, turns the engine over until it starts (much like the starters in F1 or Indy cars).



- 12) Radio Instruction Manual. This manual contains the detailed info for the various functions of the radio.

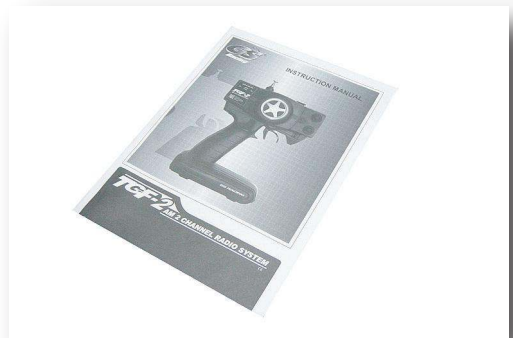

- B: Remove the body from the XUT RTR by removing the 4 body clips and gently pulling the body away from the truggy. Check the truggy over for loose screws and linkages. Also check the wheel nuts to ensure they are tight. Nitro vehicles produce a high amount of vibration, and even through shipping, screws can come loose. If you find any loose screws, tighten them now. Due to pressure variances during shipping, some oil may leak out of the diffs and shocks. This is normal, and in no way harmful to the performance of the truggy. If you find any leaks, simply wipe them clean with a rag.



Step By Step from A to Z

C: Check the tires to make sure they are fully glued to the wheels. Gently peel the tire away from the wheel, and if you find any spots where there is a gap between the tire and wheel, apply a small amount of CA glue.



D: Remove the bottom cover of the radio control and install eight AA size batteries. Always use fresh, fully charged batteries. Read all the 'Safety Precautions' in the radio manual before operating your buggy. Replace the cover.



E: Remove the plastic cap from the antenna tube, unwrap the receiver antenna wire and feed it through the antenna tube. Allow about 1" of the wire to stick out of the tube and place the cap over the tube and wire. Feed the extra receiver wire back through the hole back into the radio box.

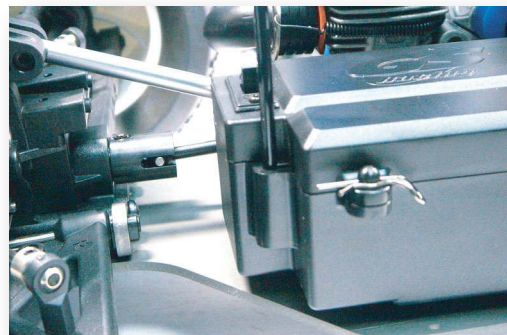

Step By Step from A to Z

F: Remove the radio box cover by removing the small clip and lifting the cover out. Remove the battery tray from the box and install four AA size batteries. Again, always use fresh, fully charged batteries. Place the battery tray back in the box and replace the cover and clip.



G: Check and adjust the ride height. Ride height is the height of the truggy at rest. Your XUT RTR is factory built to the correct ride height. However, through shipping the shock springs settle and the ride height can change. The proper ride height is front and rear arms parallel (level) with flat ground. For very smooth surfaces (i.e. paved track) you can run the truggy lower, and for very rough surfaces (i.e. rutted track) you can run the truggy a little higher. To check the ride height, place the truggy on a flat surface and press the front and rear of the truggy down several times in rapid succession. Allow the truggy to rise and rest. Look at the front and rear of the truggy at ground level. If the lower suspension arms are parallel with the ground, do nothing (as shown). If the arms are lower (inside of the arms lower than the outside), then add spacers (as shown) to raise the truggy so that the arms are level. Make sure you install the same amount of spacers to the left and right shocks, and adjust the front and rear independently.

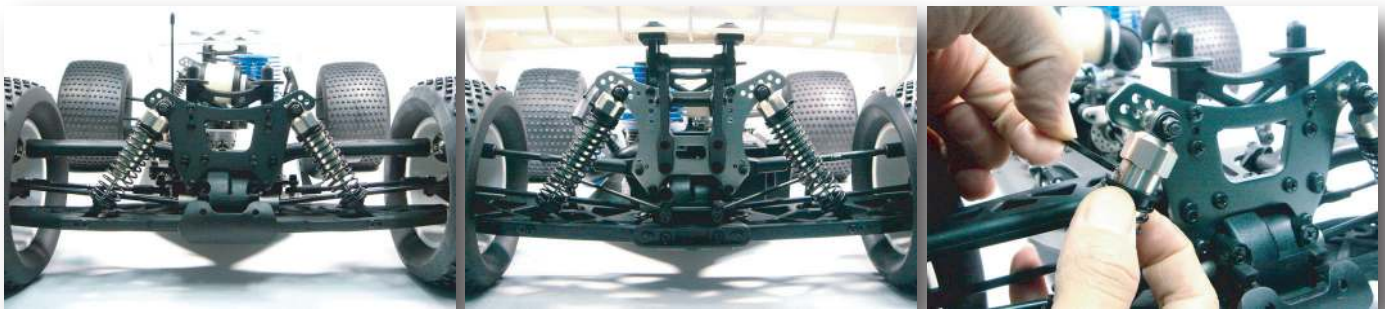

H: Now it's time to check the radio and servo settings. Install the radio antenna in the radio control unit. Turn on the radio control followed by the receiver switch in the truggy. Pull the trigger on the radio. The throttle servo (the servo closer to the rear of the truggy) should turn counter-clockwise. If the servo rotates in the opposite direction, slide the 'TH' servo reverse switch to the opposite setting. Repeat this process for the steering, by rotating the steering wheel left and right and adjusting the 'ST' switch accordingly.



Step By Step from A to Z

I: Now check the neutral 'trim' settings. With the steering wheel and trigger in the neutral position (hands off), the wheels should be pointing straight ahead, and the throttle servo horn should be pointing straight back and forth with the carburetor in the neutral (closed) position. If either servo is not centered, rotate the steering and throttle trim knobs accordingly to place both servos in the correct neutral position.

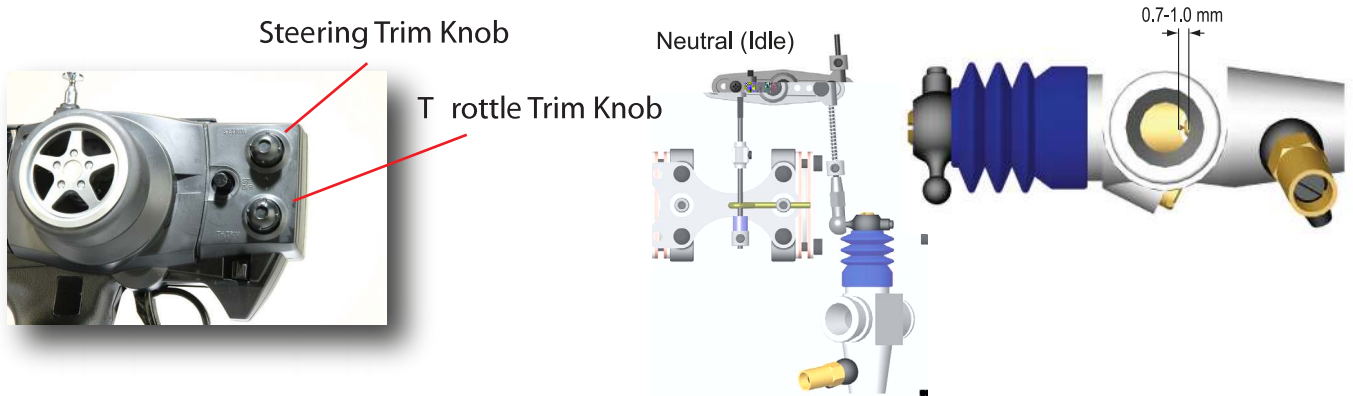

Set the steering dual rate. Dual rate is the amount of maximum steering, left and right. It is controlled by the thumb activated knob directly below the steering wheel. Rotate the knob so that the white mark is centered. Rotating the knob to the right will increase the amount of steering (smaller turning radius), and turning the knob to the left will decrease the amount of steering (bigger turning radius). We suggest keeping the white mark in the center position.

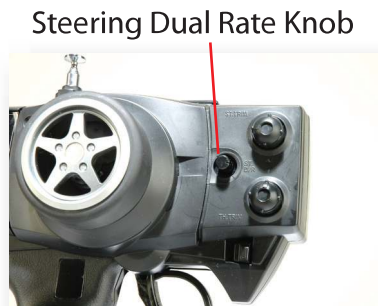

Now check the brake bias. The front and rear brakes are activated by the brake cams located in the center diff mount and can be adjusted independently. We suggest an equal brake bias front and rear. Push the trigger to activate the brakes. On a smooth paved surface, pick the rear of the truggy off the ground and push the truggy forward, with the brakes engaged. The front wheels should barely rotate as you apply pressure. Now pick up the front of the truggy and push the truggy backwards. The rear tires should have the same amount of resistance. If one end has more brake bias than the other, adjust accordingly by rotating the brake rods as shown below. You can also increase or decrease the total amount of front and rear brake using these knobs. Turn off the receiver switch and the radio switch and set aside for now.

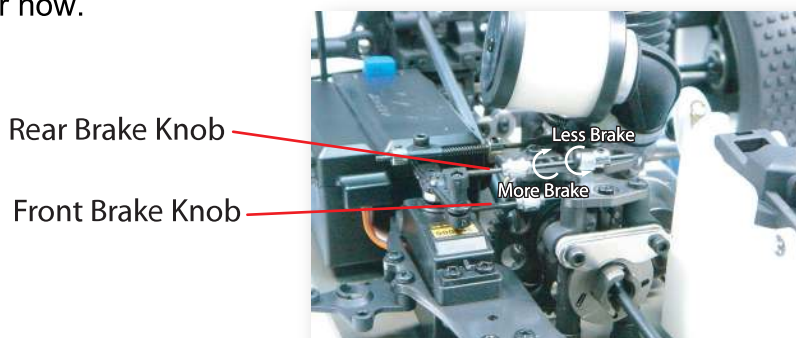

Step By Step from A to Z

J: The air filter is pre-oiled at the factory. However, it is a good idea to make sure it is well oiled before each and every run. Gently squeeze the foam of the filter. If it does not leave a residue on your fingers, apply a light coat of model air filter oil to the entire surface of the filter foam and remove excess oil with a clean rag.



K: Fill your fuel bottle with brand name 20% model car glow fuel. Lift the lid of the fuel tank, place the tube of the fuel bottle over the opening, and full with fuel. Be careful not to spill fuel on the truggy.



L: Install a fully charged 6 cell 7.2V battery into the Power Start Unit (drill start kits only). Install the battery plug into the unit. If you have not done so yet, insert the driveshaft into the unit now.



M: Install an AA size battery into the glow igniter as shown. Replace the spring and end cap and tighten fully. After usage, always remove the battery from the igniter. More powerful aftermarket rechargeable igniters are available at your local hobby shop.



Step By Step from A to Z

N: The adjustment needles (adjustment screws) on the engine carburetor are preset at the factory for engine break-in. These needles control the fuel/air mixture of the engine, and are used to tune the engine during and after break-in, and during the use of the engine. These needle settings may need minor tuning as ambient temperature, brand and nitro content of fuel, atmospheric pressure, type of surface driven on, and other factors, all have an effect on the engine idle, tune, and temperature. Tightening the needles will 'lean' the engine, making the speed faster. Loosening the needles will 'richen' the engine, making the speed slower. The factory presets, along with the information in this manual should help you properly and easily start, break-in, and tune the engine. If you are unsure about your ability to properly break-in and tune the engine, or encounter difficulty, please seek help from your local hobby shop or GS distributor. Nearly all engine problems are directly related to poor break-in procedure and improper adjustments. The following guidelines are for the GS R25MT engine only, follow them carefully!

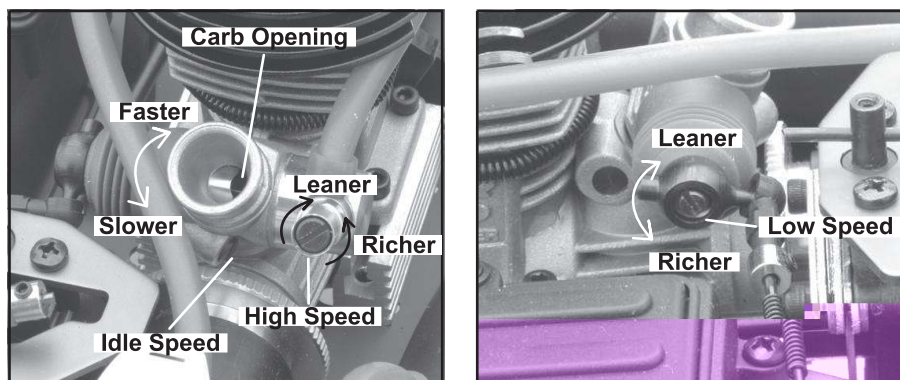

The engine will have a sticker placed over the cooling head. Remove this sticker and record the batch number and needle settings below for future reference. The High-Speed (also known as the Main or Top end) needle controls the high end rpm's of the engine. This needle is located in the brass tube directly next to the air filter. The Low-Speed (also known as the bottom end) needle control the low end rpm's of the engine. This needle is located inside the rubber boot, directly next to the ball linkage. Should you lose the baseline settings, you can easily re-tune the motor to the proper starting point by tightening (turn clockwise) the needle slowly until you begin to feel resistance. Stop, and loosen (turn counterclockwise) the needle the said number of turns. The idle screw, located just above the flywheel, does not control the fuel mixture, but instead is used to raise or lower the idle rpm by physically limiting the carburetor opening while the throttle is in the neutral or brake position. The gap in the carburetor (remove the air filter assembly to view) should be 0.8~1mm

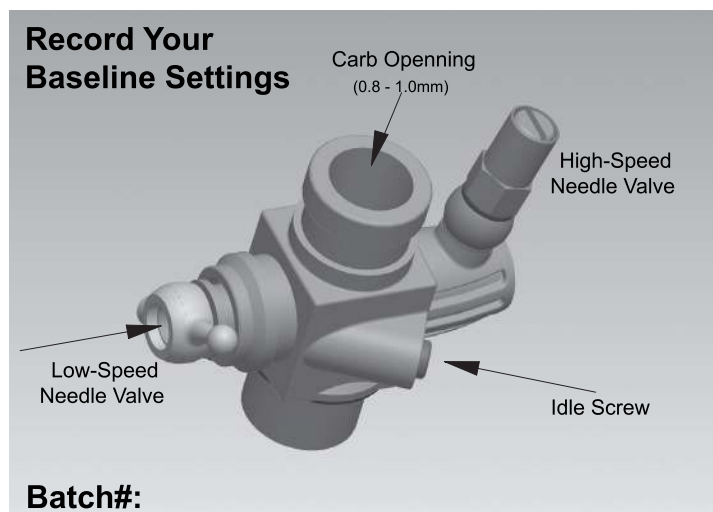

Step By Step from A to Z

N: Before starting the engine, familiarize yourself with a few ways to safely shut off the engine. The easiest way is to allow the fuel to run out. To expedite the process, you can draw the fuel out of the fuel tank with your fuel bottle. A second method is to pinch the fuel line as shown. Carefully pinch the fuel line (the tubing from the fuel tank to the engine) until the engine stops. Be careful not to cut or damage the tubing. A third way is to press the tip of a screwdriver or other tool against the flywheel, as shown. A fourth method is to cover the exhaust outlet. Do not use your bare fingers, as the exhaust gets extremely hot during use. Instead, use a thick rag and cover the outlet until the engine stops.



O: Now it's time to start the engine and begin the break in process. Turn on the radio followed by the receiver switch. Make sure the throttle servo is in the neutral position and the carburetor is in the closed position. Place the car on a block, so that the wheels are off the ground. Place a rag over the exhaust pipe outlet, pull the engine starter 3-4 times. This will force fuel into the carburetor. Remove the rag, and attach the glow igniter to the glow plug in the engine, and press the button until the engine starts. If the engine does not start within 5 seconds, stop, wait, and try again. To help aid the engine start up, you may apply a small amount of throttle during the first few seconds after it fires. If the engine does not start at all, refer to the engine troubleshooting page. If the engine starts, but shuts off due to a low idle speed, tighten (clockwise) the idle screw $\frac{1}{2}$ turn. If the engine runs for 10-30 seconds and shuts off, tighten (lean/clockwise) the low speed needle $\frac{1}{4}$ turn, and/or leave the igniter on the glow plug to keep the plug 'lit'. Since the engine runs 'rich' during break-in, keeping the glow plug 'lit' helps keep the engine from flooding and shutting off. If the engine starts but the idle is very high, loosen the idle screw $\frac{1}{2}$ turn and/or make sure the throttle is in neutral/brake and the carburetor is in the closed position.



12:00

7

9:00

3:00



Step By Step from A to Z

W: Your XUT RTR is built and setup to our Factory Team Specs. The stock setup will work well on most tracks. The only major setup change you might make is tires. The stock tires will work on a variety of surfaces and tracks, but ask the locals for the best tire for your specific track. We suggest Pro Line tires, as they are available in a wide variety of patterns and compounds. Otherwise, refer to the setup sheet in the back of the manual should you need to replace the shock or diff oils, or replace broken parts, for the correct settings. Your XUT RTR does offer a wide variety of adjustments, so experiment to fine tune to your track needs, or contact us for setup tips. We have won many races with our XUT Pro series truggies over the years, and your XUT is a capable race truggy.

X: A full line of GS option parts is available; contact us for details and/or check the back of this manual for parts listing. Fioroni also offers a full line of XUT RTR option parts, as do several other companies.

Y: Maintenance is important on any RC model. Even though your XUT RTR is an RTR, it still requires basic cleaning and maintenance. Always check for loose screws before each run. After each race weekend, disassemble the truggy (use this manual for reference) and check for bent or broken parts. Worn out or bent parts will cause other parts to bend or break. Shock and differential oils need to be replaced regularly. Clutch shoes and springs have a limited life span, so replace when performance drops. The servos in your XUT RTR also have a limited life span. Even the most expensive servos do not last forever. Your engine, if properly tuned and cared for, can last through several gallons of fuel. Always draw out all the fuel out of the tank, apply after-run oil to the engine, and remove batteries before storing the XUT RTR away.

Z: Warranty: Your XUT RTR warranty covers workmanship and manufacturing defects of the original and unmodified parts. Warranty claims resulting from crashes, abuse, improper operation, improper mounting, improper adjustment or lack of maintenance will not be honored. Ready to run does not mean maintenance free, nor does it imply that the truggy or any parts of it are impervious to wear and tear or even unexpected breakage. The GS-R25MT engine and supplied Power Start unit are only warranted against factory defects in material and/or workmanship. Under no circumstances will the engines be considered under warranty if they have been disassembled, operated on anything other than r/c car model glow fuel, run with lean needle settings, without a proper functioning air filter, or used for any purpose other than that which the engine was designed and manufactured for. In other words, if you redline the engine, or run it with a dirty air filter, or tighten the needles too far, it's not covered.



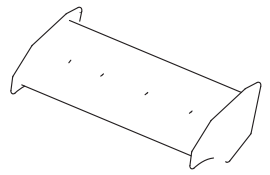

2

2

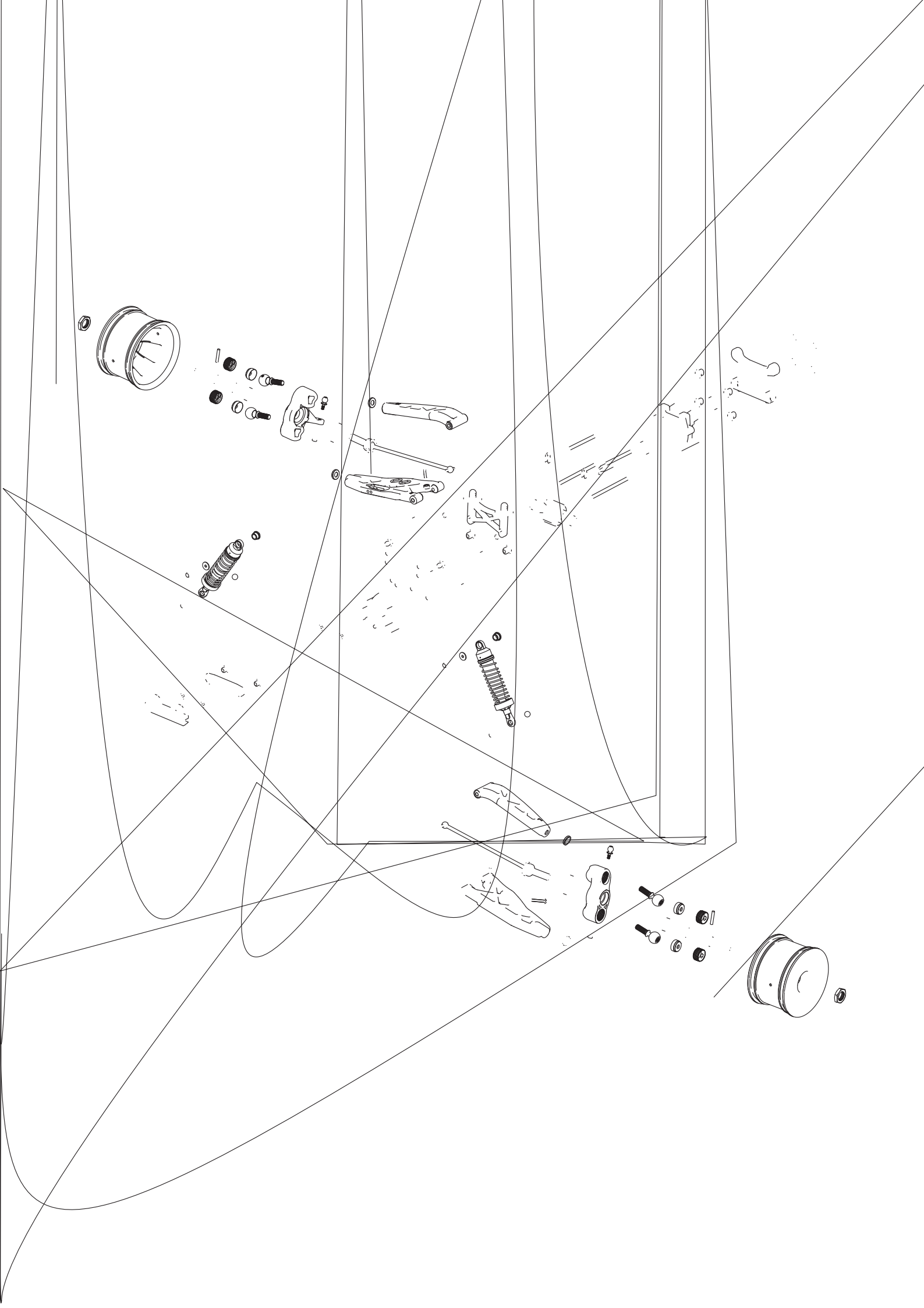

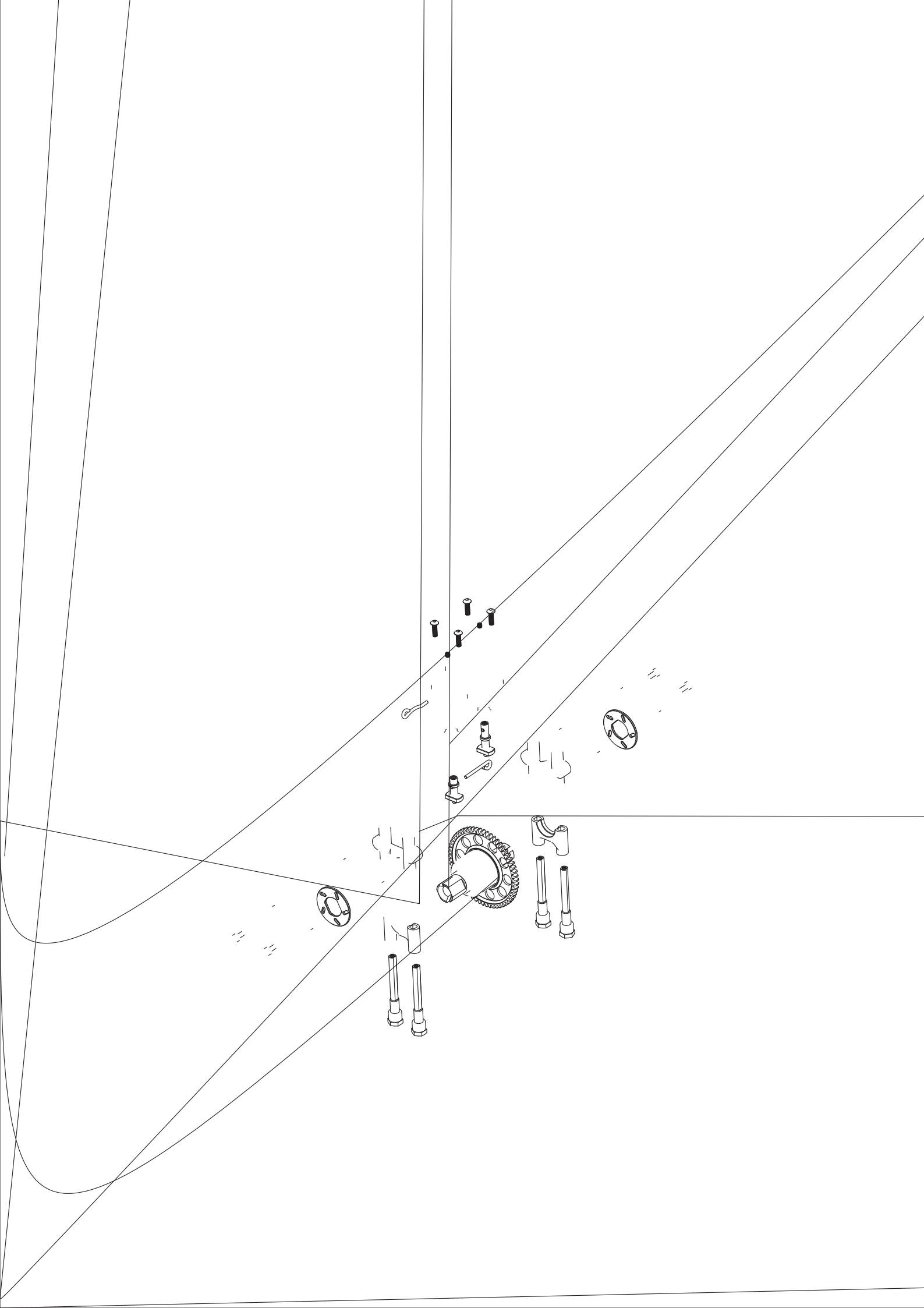



13

Shock System Assembly

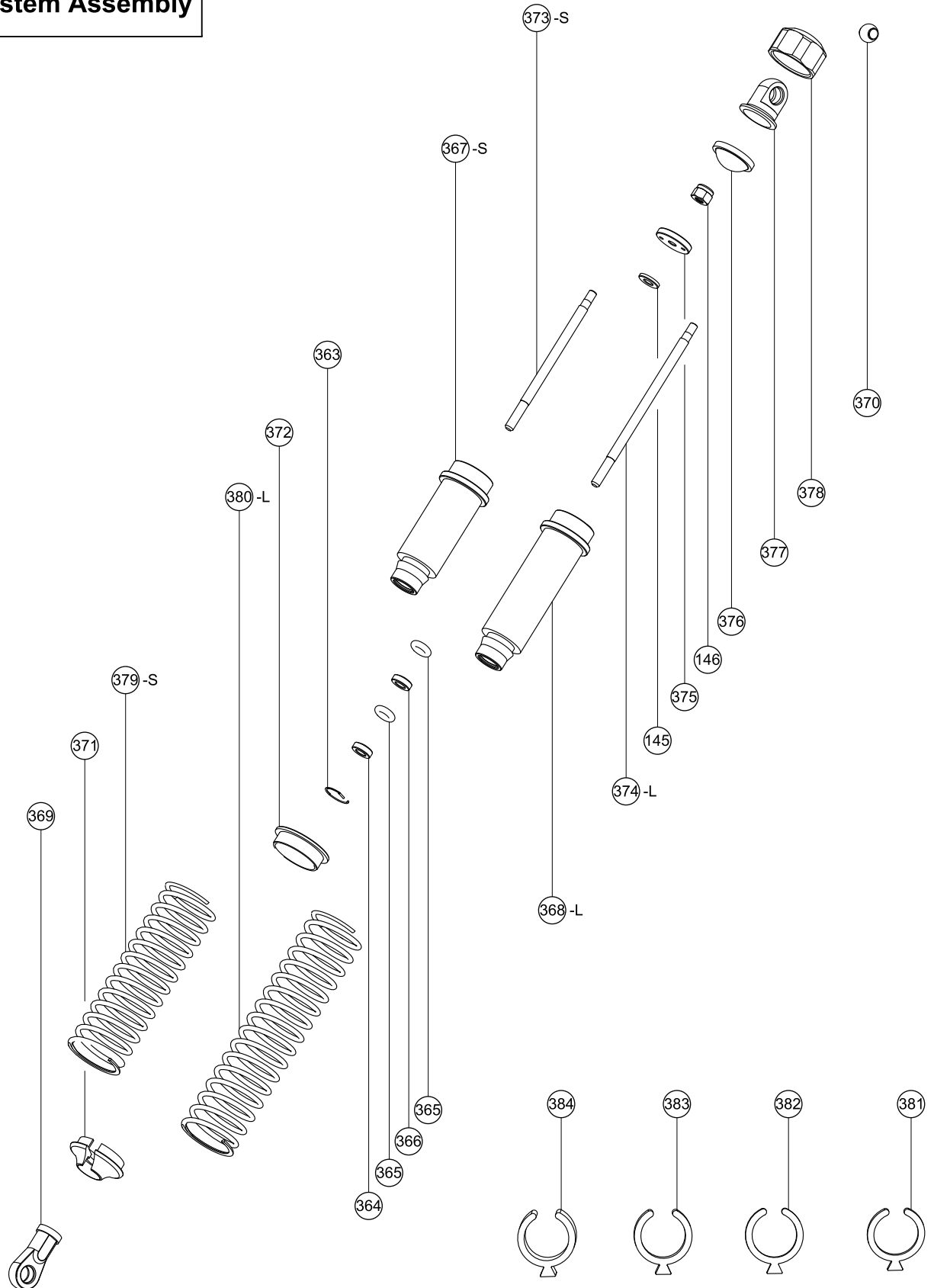

Shock Body/Piston: You will build 2 front (short) and 2 rear (long) shocks. Slide a 2.6mm washer over the stepped end of a shock shaft. Place a piston over the shaft and secure with 2.5mm locknut. You may hold the shaft with pliers, holding the pliers just above the threads at the opposite end of the shaft. Apply a drop of shock oil to the o-rings. Place an o-ring, followed by a 2mm plastic washer, a second o-ring, and 1mm plastic washer into the bottom of the shock body. Gently press the 1mm washer to seat the parts and expose the small groove in the body. Carefully place the G-ring in the shock body and snap into the groove. Apply a drop of oil to the threads of the shock shaft and carefully insert through the shock body. Tighten ball ends onto shafts until the threads of the shafts are covered. Install ball studs in ball ends, making sure they rotate freely. Keep any extra hardware as spares.

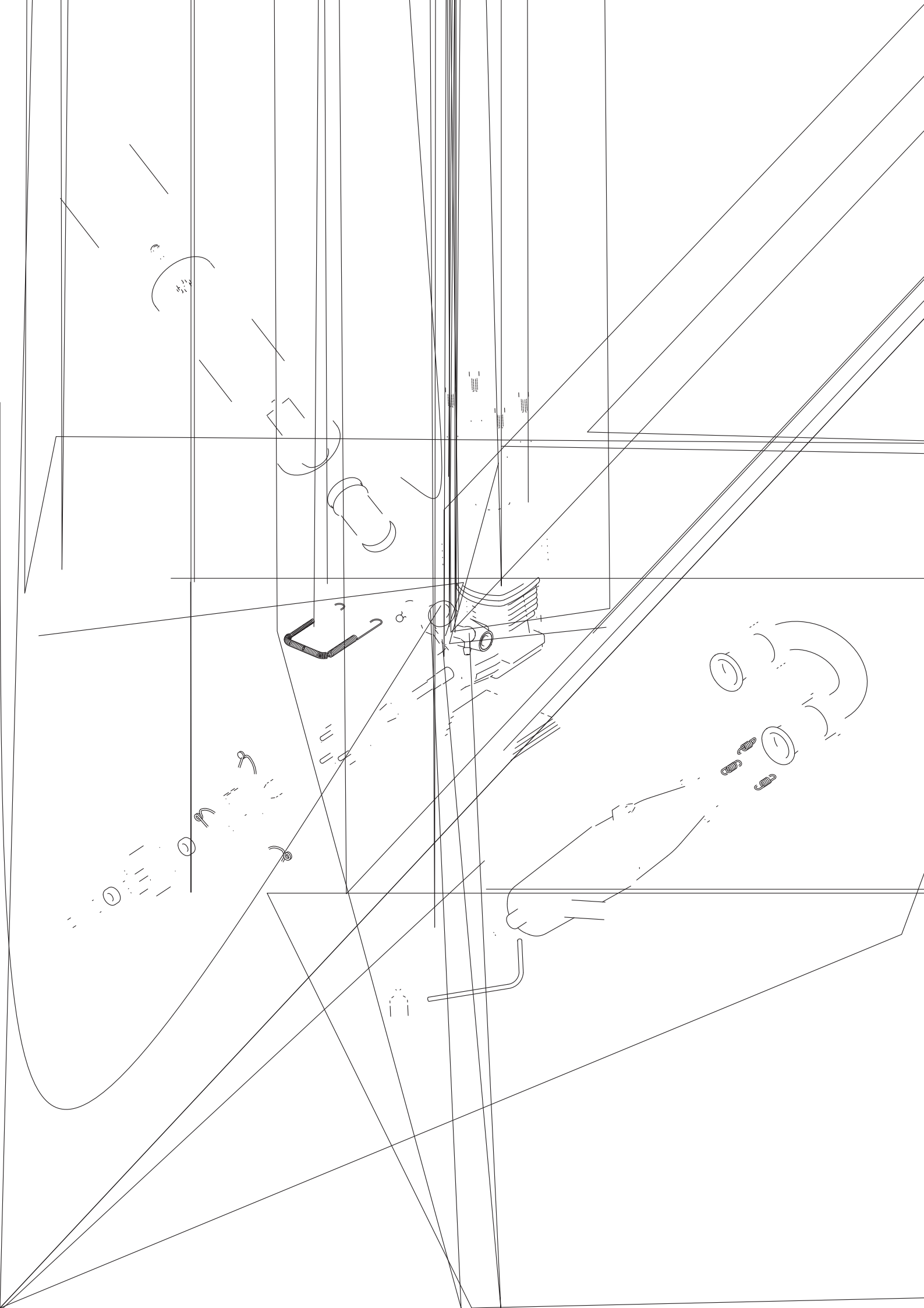

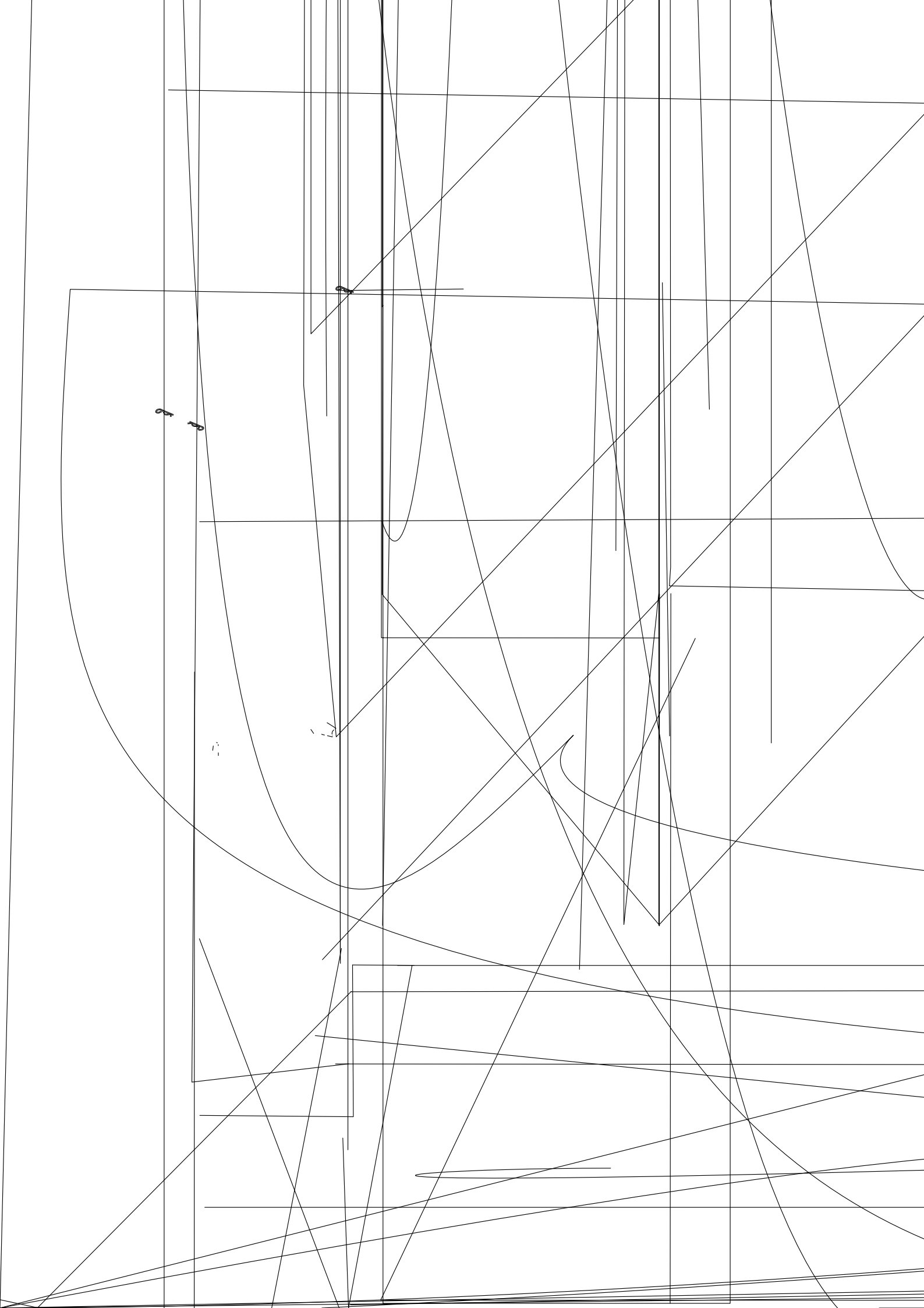

Problem	Things To Check	Solution
Engine won't start	<ol style="list-style-type: none"> 1. Fuel tank is empty. 2. Bad glowplug or dead igniter battery. 3. Fuel lines, air cleaner, or muffler is clogged. 4. Engine is flooded due to over-priming. 5. Carburetor is not adjusted properly. 	<ol style="list-style-type: none"> 1. Fill fuel tank with fuel. 2. Replace glowplug or recharge/replace igniter battery. 3. Clean or replace clogged parts. 4. Remove glowplug, turn car over to discharge fuel from cylinder. Test glowplug and replace if defective. 5. Set idle and full/slow needle adjusting screw to standard starting position.
Engine won't turn over	<ol style="list-style-type: none"> 1. Fuel tank is empty. 2. Fuel lines, fuel filter, air cleaner, or muffler is clogged. 3. Carburetor is not adjusted properly. 4. Engine has overheated. 	<ol style="list-style-type: none"> 1. Fill fuel tank with fuel. 2. Clean or replace clogged parts. 3. Re-adjust idle and full/slow needle adjusting screw. 4. Allow engine to thoroughly cool down and open main needle adjusting screw turn richer (CCW).
Bad reaction and response from engine	<ol style="list-style-type: none"> 1. Carburetor is not adjusted properly. 2. Fuel lines, air cleaner, or muffler is clogged 3. Low fuel pressure from muffler. 	<ol style="list-style-type: none"> 1. Re-adjust full/slow needle adjusting screw. 2. Clean or replace clogged parts. 3. Properly install pressure line between muffler and fuel tank.
Car isn't easy to control	<ol style="list-style-type: none"> 1. Weak transmitter and /or receiver batteries. 2. Low reception from radio antennas. 3. Servo linkages not adjusted properly. 	<ol style="list-style-type: none"> 1. Recharge or replace batteries 2. Fully extend transmitter and receiver antennas 3. Move servo to neutral then re-adjust linkage(s).
Steering does not work properly	<ol style="list-style-type: none"> 1. Weak transmitter and/or receiver batteries. 2. Bent linkages or driveshafts. 3. Loose steering components. 4. Drivetrain damage. 	<ol style="list-style-type: none"> 1. Recharge or replace batteries. 2. Check tightness of steering components and tighten if necessary. 3. Replace damaged parts.
Handling problems	<ol style="list-style-type: none"> 1. Shocks are not working properly. 2. Suspension is binding. 3. Improper tires. 	<ol style="list-style-type: none"> 1. Rebuild the shocks and replace worn or broken parts. 2. Make sure suspension moves freely. Replace worn or broken parts. 3. Use different tires.
Steering feels sluggish or vague	<ol style="list-style-type: none"> 1. Suspension is binding. 2. Damaged steering ser 	<ol style="list-style-type: none"> 1. Recharge or replace batteries. 2. Check tightness of steering components and tighten if necessary. 3. Replace damaged parts.

Name: _____
 Date: _____
 Track: _____

Track Conditions

Size: Open Med. Tight
 Traction: High Med. Low
 Surface: Smooth Med. Bumpy

Diff. Oil

Front: # _____
 Center: # _____
 Rear: # _____

Engine

Type: _____
 Gasket: _____ mm Muffler: _____
 Plug: _____ Fuel: _____

Tire

Front Type: _____ Rear Type: _____
 Foam: _____ Foam: _____

Clutch

Clutch shoes: _____
 Spring: _____ mm
 Clutch bell / Spur gear: _____

Front Suspension

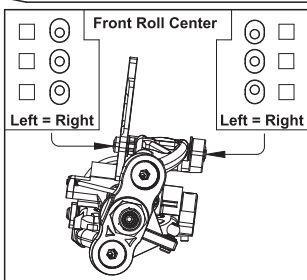

Front in-Board Toe

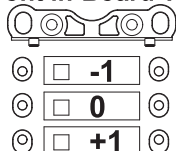

Caster angle

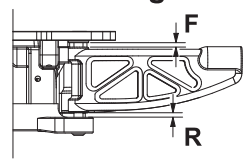

Track width _____ mm
 Camber angle Upper _____ mm
 Lower _____ mm
 Caster angle F _____ mm
 R _____ mm

Toe angle _____

Sway bar Use _____ mm
 None

Steering Ackerman 1 _____ mm
 2 _____ mm

Notes: _____

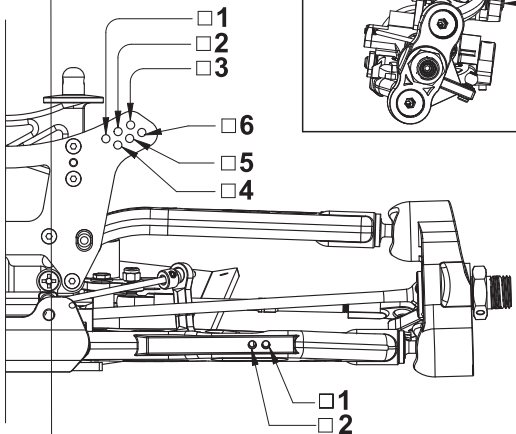

Front Shocks

Oil: _____
 Pistons: _____
 Spring: _____
 Spacer: _____ mm

Rear Suspension

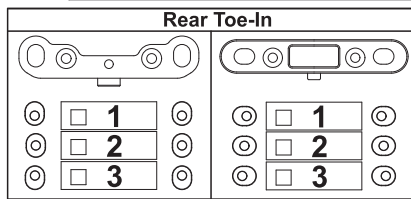

Upper arm position

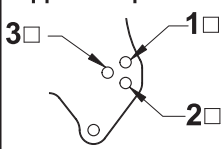

Wing Position

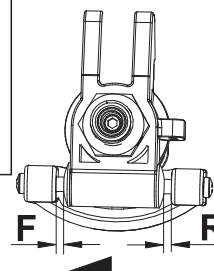
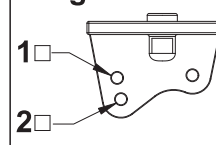

Camber angle _____ mm F _____ mm R _____ mm

Wheelbase adjustment F _____ mm Front
 R _____ mm

Sway bar Use _____ mm
 None

Rear Shocks

Oil: _____
 Pistons: _____
 Spring: _____
 Spacer: _____ mm

Notes: _____

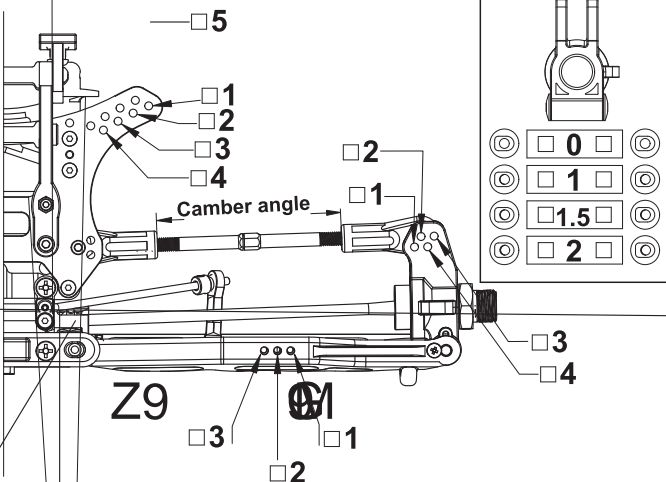
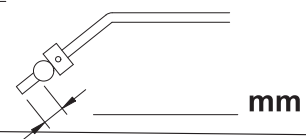

XUT RTR Key No. List

Pro RTR Key No.	Part Name	Q'ty in Use	Item No.
1	Ball Bearing 8X16X5	14	GSC-690003A
2	Diff. Gasket	3	GSC-AV006
3	Diff. Case Set	3	GSC-CL004
5	4x4mm SET Screw	4	GSC-610020
6	Diff. Large Bevel Gear	6	GSC-AV004
7	Diff. Small Bevel Gear	12	GSC-AV004
8	Pin 2.5x10.8mm	6	GSC-AV094
9	O-ring (1.75x9mm) AS009	6	GSC-ST067
10	Bevel Gear Shaft	6	GSC-AV095
14	Front/Rear Diff. Outdrive	4	GSC-CL008
16	Center Diff. Outdrives	2	GSC-CL009
17	Differential Bulkhead Set (F)	2	GSC-CL005
18	Differential Bulkhead Set (R)	2	GSC-CL005
19	Sway Bar Plate	2	GSC-CL006
20	Steering Knuckle (L)	1	GSC-CL010
21	Steering Knuckle (R)	1	GSC-CL011
22	14mm Pivot Ball Cup (5)	4	GSC-AV026
27	Front Bumper	1	GSC-CL007
28	Front Lower Arm Holder	1	GSC-CL014
29	Front Upper Arm Holder	1	GSC-CL014
31	CL-1 Caster Insert Set 1°	10	GSC-CL015
32	CL-1 Caster Insert Set 0°	10	GSC-CL015
33	CL-1 Camber, Caster Insert Set	4	GSC-CL015
34	CL-1 Camber Insert Set 0°	4	GSC-CL015
35	CL-1 Camber Insert Set 1°	4	GSC-CL015
36	CL-1 Camber Insert Set 1.5°	4	GSC-CL015
37	CL-1 Camber Insert Set 2°	4	GSC-CL015
39	Caster Insert Set 1mm	4	GSC-CL028
40	Caster Insert Set 3mm	4	GSC-CL028
49	Knuckle Pivot Ball Washer	4	GSC-AV024
50	Knuckle Pivot Ball Nut	4	GSC-AV025
53	Wheel Hub	4	GSC-STP20
54	Wheel Hub Nut	4	GSC-STP042
55	Front/Rear Lower Arm Hinge Pin	4	GSC-CL016
56	Front Upper Arm Hinge Pin	2	GSC-CL017
57	3x3mm SET Screw	10	GSC-610000
58	3x4mm SET Screw	4	GSC-610001
59	4x10mm SET Screw	4	GSC-610025
60	5x4 mm SET Screw	6	GSC-610039
61	3x8x0.5 mm Washer	4	GSC-AV099
62	12x8.2x t0.5 mm Washer	4	GSC-AV098
63	13.4x16xt0.2mm Washer	12	GSC-ST082
64	M3 Lock Nut	20	GSC-603007
65	Pin 3x16.8mm	4	GSC-602008

Team Kit Key No.	Part Name	Q'ty in Use	Item No.
66	3x10xt0.8mm Washer	4	GSC-601023
67	Ball Bearing 24x15x5mm	4	GSC-AV088
69	3.5x25mm FH/ST Screw	6	GSC-650065
70	3.5x35mm FH/ST Screw	2	GSC-650069
71	4x16mm FH HEX Screw	2	GSC-620224
72	4x18mm FH/ST HEX Screw	8	GSC-650211
73	3x16mm CAP Screw	5	GSC-611026
74	3x23mm CAP Screw	6	GSC-611030
76	Wing support	2	GSC-CL020
77	Wing Mount	2	GSC-CL020
78	Wing joint	3	GSC-CL020
79	Washer	2	GSC-CL020
80	Rear Suspension Mount	1	GSC-CL021
83	Rear Hub Carriers (L)	1	GSC-CL023
84	Rear Hub Carriers (R)	1	GSC-CL023
87	Rear Upper Sus. Arm Ball Ends Set	4	GSC-CL024
88	Rear Chassis Brace Mount	1	GSC-CL026
90	Rear Sway Bar 2.8mm	1	GSC-CL032
94	Rear Hub Carriers Hinge Pin	2	GSC-CL031
95	Rear Upper Sus. Arm Ball Stud (8.8xL9mm)	2	GSC-CL030
96	Rear Upper Sus. Arm Ball Stud (8.8xL10mm)	2	GSC-CL030
98	M3x14 Cap Screw (Half tooth)	4	GSC-611024A
101	O-ring 2.8x6.6mm TBL	2	GSC-SH-8BL
103	Steering Bellcranks (A)	1	GSC-CL036
104	Steering Bellcranks (B)	1	GSC-CL036
105	Steering Bellcranks (C)	1	GSC-CL036
106	6.8mm Steering Linkage Ball End	4	GSC-CL041
108	Servo Saver Adjustable Pipe	1	GSC-CL038
109	Servo Saver Nut	1	GSC-CL038
110	Servo Saver Spring	1	GSC-CL038
111	Servo Saver Shafts	2	GSC-CL037
115	3x10mm OH/ST HEX Screw	1	GSC-613203
117	Ball Bearing 6x10x3mm	4	GSC-690005
118	6.8mm Steering Linkage Ball Stud	5	GSC-CL042
119	Servo Saver Steering Plate Screws	2	GSC-CL039A
120	Servo Saver Steering Plate bushings	2	GSC-CL039A
122	Center Diff . Mount Set A	2	GSC-AV008
123	Center Diff . Mount Set B	2	GSC-AV008
128	Brake Calipers A	2	GSC-CL035
129	Brake Calipers C	2	GSC-CL035
133	Brake Cam Long	1	GSC-CL034
134	Brake Cam Short	1	GSC-CL033
136	Brake Lever	1	GSC-CL033
137	Shock Body (S)	2	GSC-25076

XUT RTR Key No. List

Pro RTR Key No.	Part Name	Q'ty in Use	Item No.
138	Shock Body (L)	2	GSC-25077
145	2.6x6x t0.5mm Washer	6	GSC-ST105
146	M2.5 Lock Nut	4	GSC-ST105
161	Pilot Nut #117	1	GSC-ST032
162	Exhaust Gasket For .21 Engine	2	GSC-E21TBL
163	Manifold stay #144	1	GSC-ST071
164	Clutch Bell 13T (N1-CHB13B)	1	GSC-ST001
166	Clutch Spring (B11-001)	3	GSC-ST003
167	Manifold Holder Spring	2	GSC-ST078
168	Ball Bearing 5x10x4mm	2	GSC-581814
170	Cone Collar	1	GSC-ST002A
172	3X6mm CAP Screw	1	GSC-611020
173	3x8x1mm Washer	4	GSC-601008
174	5x7x0.2mm Washer	2	GSC-ST065
175	M3X12 CAP	5	GSC-611023
176	M3 Spring Washer	4	GSC-601005
177	4x8mm I-Head Screw	4	GSC-615001
181	Fuel Tank Posts-A (ST2-126)	1	GSC-AV092
182	Fuel Tank Posts-B (ST2-127)	1	GSC-AV092
183	Silicone Fuel Tubing 2.4x5.5mm/3ft (BL)	2	GSC-24553TBL
184	Air Filter Foam	1	GSC-701017-1
186	Air Filter Adapter	1	GSC-701017
187	Air Filter base	1	GSC-701017
188	Air Filter End Cap	1	GSC-701017
189	Zip tide 5X120	2	GSC-701017
192	Radio Box-A	1	GSC-AV069
193	Radio Box-B	1	GSC-AV069
194	Radio Tray Post (A)	1	GSC-CL047
195	Radio Tray Post (B)	1	GSC-CL047
196	Radio Tray Post (C)	1	GSC-CL047
197	Servo Mount	2	GSC-AV072
198	Brake Rod Support-Up	1	GSC-AV072
199	Brake Rod Support-Lower	1	GSC-AV072
200	Throttle Rod Support	1	GSC-AV072
201	Transponder Mount	1	GSC-AV089
202	Throttle Ball End	1	GSC-AV072
203	Steering Servo Linkage Ball End	2	GSC-CL049
204	Servo Horn Adapter,Black (KO,Sanwa,Air)	2	GSC-900007BK
205	Servo Horn Adapter,Black (J)	2	GSC-900007BK
206	Servo Horn Adapter,Black (F)	2	GSC-900007BK
207	Servo Horn Adapter,Black (H)	2	GSC-900007BK
208	Servo Horn (BK)	2	GSC-900007BK
209	Silicone Switch Cover	1	GSC-COV001TBL
210	Turnbuckle 3x40mm	1	GSC-250147C

Team Kit Key No.	Part Name	Q'ty in Use	Item No.
211	5.8mm ball stud	2	GSC-CL049
212	Stoper (CU2)	4	GSC-AV072
213	Linkage Rod 2x55mm	3	GSC-AV072
214	Adjuster Knob #137	2	GSC-AV072
217	FH3x14mm	2	GSC-620028
218	Body Pin (R4)	2	GSC-60004A
219	M2X15 RH	1	GSC-AV072
220	M2X33 BH	2	GSC-AV069
223	Tube Cap	1	GSC-AV091
225	Body Pin (R8)	8	GSC-80006
226	CL-1 Wing (WH)	1	GSC-CL050WH
231	Cross Wrench-7/8/10/17mm	1	GSC-706051
232	BH3x8mm	4	GSC-640022
233	Cross Wrench-4/5/5.5/7mm	1	GSC-706006
234	HEX Wrench (5mm)	1	GSC-706009
240	M3x14mm CAP SCREW	4	GSC-611024
245	Linkage spring	1	GSC-AV072
250	M6.1x17.5xT0.3mm Steel Shim for Diff	6	GSC-CLP033
253	RTR Crown Gear 38T	2	GSC-CLR001
254	RTR Pinion Gear 11T	2	GSC-CLR002
255	Drive Joint	2	GSC-ST029
259	Rear Wheel Axle	2	GSC-AV044
264	Servo Saver Bushing, Pastic, 6x10mm	4	GSC-CLR006
265	Brake Cam Bushing, Flanged	2	GSC-AV104
266	Disc Brake	2	GSC-AV061
267	CL-1 RTR Engine Mount	2	GSC-CLR008
268	RTR Fly Wheel	1	GSC-ST002
275	Manifold Spring Holder	1	GSC-ST078A
276	Muffler	1	GSC-ST081
277	Manifold	1	GSC-ST079
299	Silicone Coupler	1	GSC-CMS-8TBL
300	RTR Antenna	1	GSC-ST076
301	3x10mm FH CRO_Tp3X10	18	GSC-650024
302	FH CRO_Tp3X8	6	GSC-650023
304	BH CRO_M3X18	4	GSC-640029
305	BH CRO_3X16	4	GSC-640028
306	BH CRO_Tp3X12	5	GSC-670024
307	BH CRO_M3X10	9	GSC-640023
309	FH CRO_M4X10	7	GSC-620079
310	FH CRO M3X10	7	GSC-620025
311	FH CRO_Tp3X12	22	GSC-650025
312	BH CRO_Tp3X18	4	GSC-670029
313	FH CRO_3X20	4	GSC-620034
314	BH CRO_Tp3X15	4	GSC-670027

XUT RTR Key No. List

Pro RTR Key No.	Part Name	Q'ty in Use	Item No.
315	BH CRO_M3X12	1	GSC-640024
321	M4*15TP BH	2	GSC-670080
352	CL/XUT RTR Rear Anti Square	1	GSC-CLR013
354	CL-1 RTR Front Lower Suspension Plate	1	GSC-CLR015
355	14mm Pivot Set For CL-1 RTR	4	GSC-CLR016
363	C-ring	4	GSC-600026
364	Shock Collar, Thin	4	GSC-80007
365	Silicone O-ring, P3	8	GSC-30005
366	Shock Collar, Thick	4	GSC-80007
367	Shock Body, Front	2	GSC-ST072A
368	Shock Body, Rear	2	GSC-ST073A
369	Ball End, 5.8 mm	4	GSC-ST084
370	5.8mm Pivot Ball for Storm Shocks	8	GSC-250106
371	Spring Collar	4	GSC-ST084
372	Spring Cup	4	GSC-ST084
373	Shock Shaft, 52 mm	2	GSC-ST072B
374	Shock Shaft, 61 mm	2	GSC-25072
375	Shock Piston	4	GSC-ST084
376	Silicone Shock Bladder	4	GSC-SH-8TBL
377	Shock End Cap	4	GSC-ST084
378	Shock Sealed End Cup	4	GSC-250033
379	Shock Spring Set, Short	2	GSC-ST086
380	Shock Spring Set, Long	2	GSC-ST086
381	Spring Adjuster, 1 mm	8	GSC-ST083
382	Spring Adjuster, 2 mm	8	GSC-ST083
383	Spring Adjuster, 5 mm	4	GSC-ST083
384	Spring Adjuster, 10 mm	4	GSC-ST083
385	Shock Bushing	4	GSC-ST085
404	XUT Body Mount	2	GSC-XT002
407	XUT Rear Lower Suspension Arms (L)	1	GSC-XT003
408	XUT Rear Lower Suspension Arms (R)	1	GSC-XT003
409	5.8xmm Bar Stud Mount	4	GSC-ST046
410	Sway Bar Ball End (L)	4	GSC-ST046
411	3X12 SET	4	GSC-ST046
412	5.8xmm Bar Stud	4	GSC-ST046
413	Sway Bar Ball End (S)	4	GSC-ST046

Team Kit Key No.	Part Name	Q'ty in Use	Item No.
414	Rear Upper Suspension Arm	2	GSC-XT010
415	XUT CVD Drive Shaft	2	GSC-XT004
416	XUT Front Lower Suspension Arms (L)	1	GSC-XT005
417	XUT Front Lower Suspension Arms (R)	1	GSC-XT005
418	XUT Front Upper Suspension Arms (L)	1	GSC-XT006
419	XUT Front Upper Suspension Arms (R)	1	GSC-XT006
420	XUT Front Chassis Brace Mount	1	GSC-XT007
421	XUT Front Chassis Brace	1	GSC-XT008
422	XUT Chassis Brace Ball End	2	GSC-XT008
423	XUT Chassis Brace Ball Stud	2	GSC-XT008
424	XUT Steering Linkage Turnbuckles	2	GSC-XT009
425	Center Diff Support Plate	1	GSC-XT012
426	XUT Rear Brake Lever	1	GSC-XT013
427	XUT Center Diff. Mount Posts	4	GSC-XT014
428	GS R25MT Pull Starter Engine	1	GSC-890067
429	GS R25MT Drill Starter Engine	1	GSC-890067D
430	XUT Muffler Stay Wire	1	GSC-XT015
431	Heavy Duty Clutch Shoe	3	GSC-110004
432	XUT Fuel Tank 150CC	1	GSC-XT016
433	XUT Radio tray	1	GSC-XT017
434	Servo Spacer 6mm	2	GSC-XT018
435	XUT Dish Wheel	4	GSC-110036WH
436	XUT Rear Chassis Brace	1	GSC-XT019
438	XUT RTR Body Decal	1	GSC-XT020
439	XUT Cubic Tire	4	GSC-XT021
440	XUT Tire Insert	4	GSC-XT021
441	CL Series Front Support Plate	1	GSC-XT022
443	XUT RTR Chassis	1	GSC-XT011
444	XUT RTR 58T Spur Gear	1	GSC-XTR001
445	XUT RTR Front Shock Tower	1	GSC-XTR002
446	XUT RTR Rear Shock Tower	1	GSC-XTR003
447	XUT RTR Center Drive Shaft 116mm	1	GSC-XTR004
448	XUT RTR Center Drive Shaft 132mm	1	GSC-XTR005
449	XUT RTR Rear Drive Shaft	2	GSC-XTR006
450	XUT RTR Prepainted Body	1	GSC-150034A
451	XUT RTR Manual	1	GSC-XTR007

XUT RTR Spare Part List

Item No.	Part Name
GSC-XTR001	XUT RTR 58T Spur Gear
GSC-XTR002	XUT RTR Front Shock Tower
GSC-XTR003	XUT RTR Rear Shock Tower
GSC-XTR004	XUT RTR Center Drive Shaft 116mm

Item No.	Part Name
GSC-XTR005	XUT RTR Center Drive Shaft 132mm
GSC-XTR006	XUT RTR Rear Drive Shaft
GSC-XTR007	XUT RTR Manual
GSC-XT002	XUT Body Mount

XUT RTR Spare Part List

Item No.	Part Name
GSC-XT003	XUT Rear Lower Suspension Arms
GSC-XT004	XUT CVD Drive Shaft
GSC-XT005	XUT Front Lower Suspension Arms
GSC-XT006	XUT Front Upper Suspension Arms
GSC-XT007	XUT Front Chassis Brace Mount
GSC-XT008	XUT Front Chassis Brace Set
GSC-XT009	XUT Steering Linkage Set
GSC-XT010	XUT Rear Upper Suspension Arm Set
GSC-XT011	XUT RTR Chassis
GSC-XT012	Center Diff Support Plate
GSC-XT013	XUT Rear Brake Lever
GSC-XT014	XUT Center Diff. Mount Posts
GSC-XT015	XUT Muffler Stay Wire
GSC-XT016	XUT Fuel Tank 150CC
GSC-XT017	XUT Radio tray
GSC-XT018	Servo Spacer 6mm
GSC-XT019	XUT Rear Chassis Brace
GSC-XT020	XUT RTR Body Decal
GSC-XT021	XUT Cubic Tire
GSC-XT022	CL Series Front Support Plate
GSC-CL001	44T Spur Gear
GSC-CL004	Diff. Case Set
GSC-CL005	Differential Bulkhead Set
GSC-CL006	Sway Bar Plate
GSC-CL007	Front Bumper
GSC-CL008	Front/Rear Diff. Outdrive(2)
GSC-CL009	Center Diff. Outdrives (2)
GSC-CL010	Steering Knuckle (L)
GSC-CL011	Steering Knuckle (R)
GSC-CL014	Front Upper Arm Holder
GSC-CL015	CL-1 Camber, Caster Insert Set (2 Set)
GSC-CL016	Front/Rear Lower Hinge Pin (4)
GSC-CL017	Front Upper Arm Hinge Pin (2)
GSC-CL020	Wing Stay Set
GSC-CL021	Rear Suspension Mount
GSC-CL023	Rear Hub Carriers (R)
GSC-CL024	Rear Upper Sus. Arm Ball Ends Set
GSC-CL026	Rear Chassis Brace Mount
GSC-CL028	Caster Insert Set
GSC-CL030	Rear Upper Sus. Arm Ball Stud Set
GSC-CL031	Rear Hub Carriers Hinge Pin (2)
GSC-CL032	Rear Sway Bar 2.8mm
GSC-CL033	Brake Cam Short
GSC-CL034	Brake Cam Long

Item No.	Part Name
GSC-CL035	Brake Calipers
GSC-CL036	Steering Bellcranks (A/B/C)
GSC-CL037	Servo Saver Shafts
GSC-CL038	Servo Saver Nut/Spring
GSC-CL039A	Servo Saver Steering Plate bushings
GSC-CL041	6.8mm Steering Linkage Ball End (5)
GSC-CL042	6.8mm Steering Linkage Ball Stud (5)
GSC-CL047	Radio Tray Post Set (A/B/C)
GSC-CL049	CL-1 Steering Servo Linkage Set
GSC-CL050WH	CL-1 Eagle Wing Set (WH) (w/Sticker)
GSC-CLP033	M6.1x17.5xT0.3mm Steel Shim for Diff
GSC-CLR001	RTR Crown Gear 38T
GSC-CLR002	RTR Pinion Gear 11T
GSC-CLR006	Servo Saver Bushing, Pastic, 6x10mm
GSC-CLR008	CL-1 RTR Engine Mount
GSC-CLR013	CL/XUT RTR Rear Anti Square
GSC-CLR015	CL/XUT RTR Front Lower Suspension Plate
GSC-CLR016	14mm Pivot Set For CL-1 RTR
GSC-110004	Heavy Duty Clutch Shoe
GSC-AV004	Diff. Bevel Gear Set
GSC-AV006	Diff. Gasket (3)
GSC-AV008	Center Diff. Mount Set
GSC-AV024	Knuckle Pivot Ball Washer (5)
GSC-AV025	Knuckle Pivot Ball Nut (5)
GSC-AV026	14mm Pivot Ball Cup (5)
GSC-AV044	Rear Wheel Axle (2)
GSC-AV061	Disc Brake
GSC-AV069	Radio Box Set
GSC-AV072	Throttle Linkage Set
GSC-AV088	Ball Bearing 15x24x5mm (4)
GSC-AV089	Transponder Mount
GSC-AV091	Pro Antenna (Black) (2)
GSC-AV092	Fuel Tank Post Set (A/B)
GSC-AV094	Pin 2.5x10.8mm
GSC-AV095	Bevel Gear Shaft
GSC-AV098	Washer 12x8.2x0.5mm
GSC-AV099	Washer 3x8x0.5mm
GSC-AV104	Brake Cam Bushing, Flanged (Plastic)
GSC-ST001	Cluth Bell ,13T
GSC-ST002	Flywheel & Collet
GSC-ST002A	Cone Collar
GSC-ST003	Clutch Spring
GSC-ST029	Drive Joint (2)
GSC-ST032	Pilot Nut

XUT RTR Spare Part List

Item No.	Part Name
GSC-ST046	Sway Bar Ball End (S)
GSC-ST065	Clutch Shim, 5X7X0.3mm (10)
GSC-ST067	O-Ring, AS009 (6)
GSC-ST071	Muffler Holder Set
GSC-ST072A	Shock Body, Front
GSC-ST072B	Shock Shaft, 52 mm
GSC-ST073A	Shock Body, Rear
GSC-ST076	RTR Antenna
GSC-ST078	Manifold Spring Holder Set
GSC-ST078A	Manifold Holder Spring (2)
GSC-ST079	Manifold Set
GSC-ST081	GS Muffler
GSC-ST082	13.4x16x0.2mm Shim (10)
GSC-ST083	Shock Preload Spacers
GSC-ST084	Shock Spring Retainers & RTR Pistons
GSC-ST085	Shock Bushing
GSC-ST086	Shock Spring Set
GSC-ST105	Storm/ SUT 2.5mm Shock Locknut kit (10 pcs)
GSC-STP042	Hard Anodized Wheel Nut (4)
GSC-STP20	Hard Anodized Wheel Hub & Nut Set (2)
GSC-110036WH	XUT Dish Wheel (WH) (2PC)
GSC-150034A	XUT RTR Prepainted Body
GSC-24553TBL	Silicone Fuel Tubing 2.4x5.5mm/3ft (BL)
GSC-250033	Shock Sealed End Cup
GSC-250106	5.8mm Pivot Ball for Storm Shocks
GSC-250147C	Turnbuckle Rod-3x40mm (2)
GSC-25072	Shock Shaft, 61 mm
GSC-25076	Shock Body (S)
GSC-25077	Shock Body (L)
GSC-30005	Silicone O-ring, P3
GSC-581814	Ball Bearing 5x10x4mm
GSC-600026	C-ring
GSC-60004A	Body Pin (R4)
GSC-601005	M3 Spring Washer (10)
GSC-601008	Washer, 3x8x1mm (10)
GSC-601023	3x10xt0.8mm Shim (10)
GSC-602008	Pin 3x16.8mm
GSC-603007	M3 Nylon Nut (10)
GSC-610000	M3x3 set screw (10)
GSC-610001	M3x4 set screw (10)
GSC-610020	M4x4 set screw (10)
GSC-610025	M4x10mm Set Screw (10)
GSC-610039	M5x4 set screw (10)
GSC-611020	3X6 Cap Screw (10)
GSC-611023	M3X12 Cap Screw (10)

Item No.	Part Name
GSC-611024	M3x14mm Cap Screw (10)
GSC-611024A	M3x14 Cap Screw (Half Thread) (10)
GSC-611026	M3x16 Cap Screw (10)
GSC-611030	M3x23 Cap Screw (10)
GSC-613203	3x10mm OH/ST HEX Screw
GSC-615001	M4x8 B/H Hex Screw (10Pcs)
GSC-620025	M3X10 FH Screw (10)
GSC-620028	M3x14mm FH Screw (10)
GSC-620034	M3X20 FH Screw (10)
GSC-620079	M4X10 FH Screw (10)
GSC-620224	4x16mm FH HEX Screw
GSC-640022	BH M3x8mm (10)
GSC-640023	BH M3x10mm (10)
GSC-640024	BH M3x12mm (10)
GSC-640028	BH M3x16mm (10)
GSC-640029	BH M3x18mm (10)
GSC-650023	M3x8mm FH/ST Screw (10)
GSC-650024	M3x10mm FH/ST Screw (10)
GSC-650025	M3x12mm FH/ST Screw (10)
GSC-650065	3.5x25mm FH/ST Screw (10)
GSC-650069	3.5x35mm FH/ST Screw (10)
GSC-650211	4x18mm FH/ST HEX Screw (10)
GSC-670024	M3X12 BH/ST Screws (10)
GSC-670027	M3X15 BH/ST Screws (10)
GSC-670029	M3X18 BH/ST Screws (10)
GSC-670080	M4X15 BH/ST Screws (10)
GSC-670086	M3.5X32 BH/TP Screws (10)
GSC-690003A	Ball Bearing 8x16x5mm (6)
GSC-690005	Ball Bearing 6x10x3mm
GSC-701017	1/8 High Performance Air Filter Set
GSC-701017-1	1/8 High Performance Air Filter Set
GSC-706006	Cross Wrench-4/5/5.5/7mm
GSC-706009	HEX Wrench (5mm)
GSC-706051	Cross Wrench-7/8/10/17mm
GSC-80006	Body Pin (R8)
GSC-80007	Shock O-ring Retainer Kit (Storm RTR)
GSC-890067	GS R25MT Pull Starter Engine
GSC-890067D	GS R25MT Drill Starter Engine
GSC-900007BK	Servo Horn (BK)
GSC-CMS-8TBL	Silicone Coupler
GSC-COV001TBL	Silicone Switch Cover
GSC-E21TBL	Exhaust Gasket For .21 Engine
GSC-SH-8BL	O-ring 2.8x6.6mm TBL
GSC-SH-8TBL	Silicone Shock Bladder

Warranty



Warranty

Your XUT RTR warranty covers workmanship and manufacturing defects of the original and unmodified parts. Warranty claims resulting from crashes, abuse, improper operation, improper mounting, improper adjustment or lack of maintenance will not be honored.

Contact your local hobby shop or GS distributor for all claims and questions. Claims must be well documented. All Claims are subject to expert examination approval by **GS RACING**.

-GS RACING-



XUT RTR Option Parts



GSC-XTP001
7075 Front Shock Tower



GSC-XTP002
7075 Rear Shock Tower



GSC-XTP003
XUT Front Center CVD Drive Shaft



GSC-XTP004
XUT Rear Center CVD Drive Shaft



GSC-XTP005
XUT 56T Spur Gear



GSC-XTP006
XUT 17mm Hex Axle Adapter



GSC-CLP008
Aluminum Rear Anti-Squat Mount



GSC-CLP011
14mm Knuckle Pivot Ball (4)
(Aluminum Hard Anodized)



GSC-CLP013
7075 T6 Engine Mounts
(fits all .21/.25 engines)



GSC-CLP014
7075 T6 Front Lower
Suspension Plate (5mm)



GSC-CLP015
Aluminum CNC Front Lower
Arm Holder



GSC-CLP016
Aluminum CNC Front Upper
Arm Holder



GSC-CLP017
7075 T6 Rear Suspension
Mount



GSC-CLP024
CL-1 Aluminum Wing joint
Set

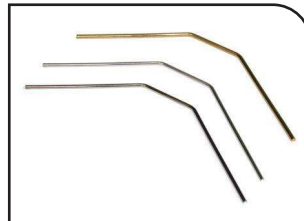

GSC-CLP026
Rear Sway bar Set
(2.6mm/2.8mm/3.0mm)



GSC-CLP029
Lightend Center Diff.
Outdrive (2)



GSC-CLP030
Lightend Front/Rear Diff.
Outdrive



GSC-CLP031
Cro-Moly 14mm Knuckle
Pivot Ball Turnbuckles (4)



GSC-AVP027
Aluminum Radio Tray Post C



GS-UT02
SUT Side Guard (L/R)

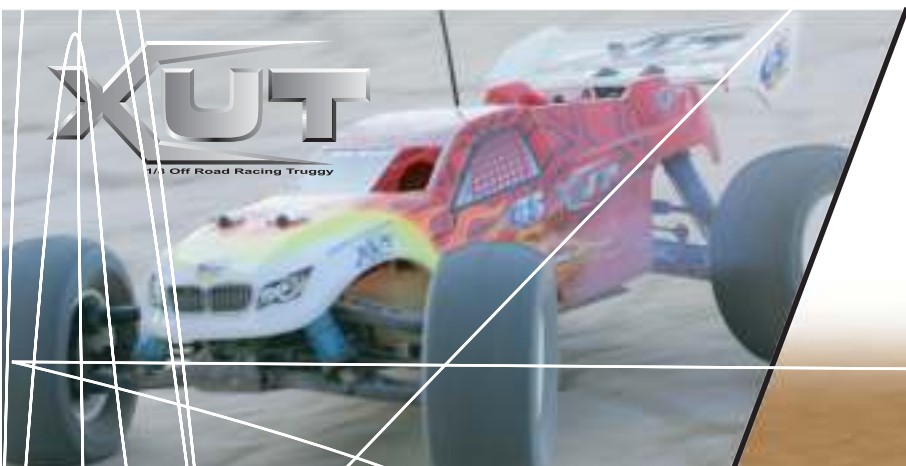

-
-
-



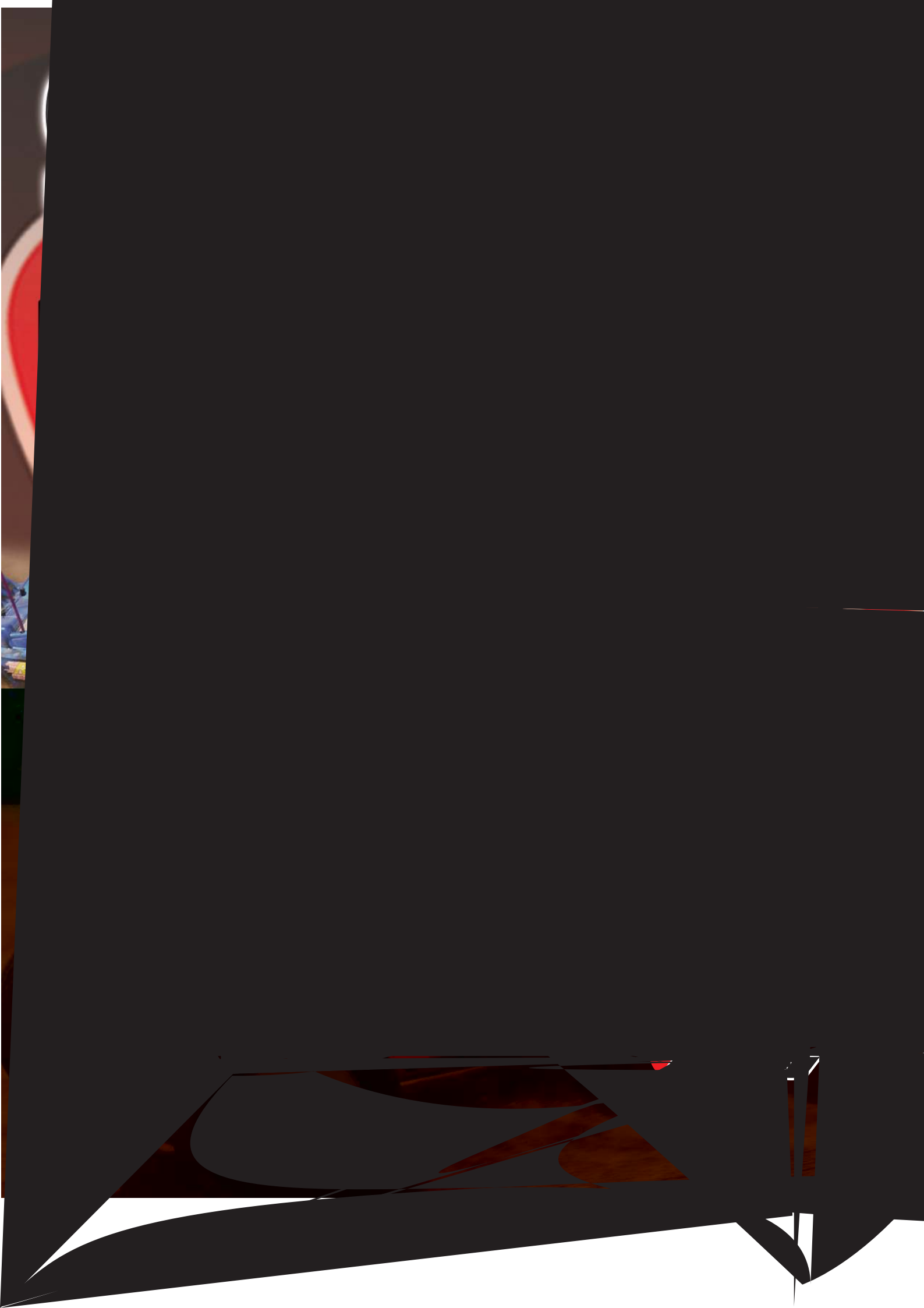

VISION RTR

The Vision RTR is based on the race winning high-performance design of the Vision Pro, GS Racing makes the Vision RTR a great choice for a first nitro R/C car. With the ease of an RTR in a high-performance platform, the Vision RTR has the best of both worlds, all at a good value. Features like an adjustable 2-speed automatic transmission, sealed radio box, oil-filled threaded shocks with adjustable pistons, sealed gear diffs, aluminum chassis, full precision ball bearings, then topped off with a professionally painted body and per-mounted rubber tires makes the Visions RTR a worthy contender at any club race.

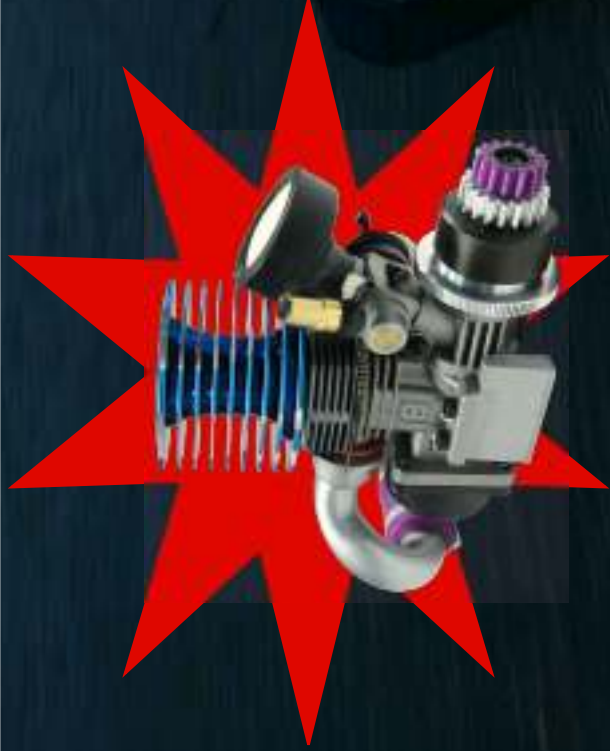

POWERS UP

Power Up, 3 cc race tuned engine, 1/10 ultimate racing machine !!!

Vision RTR Features:

- 3mm T6 aluminum countersunk chassis
- .18 rear exhaust engine
- Fully adjustable pivot-ball suspension
- Finished pre-mounted body
- GS Racing's camber clip system
- GS radio system include
- 2 speed transmission
- 75cc fuel tank with splash guard
- Threaded shock bodies with adjustable dampening
- Sealed radio box with transponder mount
- Adjustable 2 speed system

Vision RTR Plus Technical Data:

- Length/380 mm
- Width/198 mm
- Height/104 mm
- Ground Clearance/Front~Rear : 4.5~5.5 mm
- Wheelbase/260mm
- Gear Ratio/Low 7.55 : 1/High 5.82 : 1
- Track/172 mm
- Weight/1700 g
- Tank/75 cc



Available at your specialised GS dealer !!



www.GSRACING.com

