

TRAXXAS

OWNERS MANUAL



RUSTLER
MODEL 3708
VXL
BRUSHLESS



STAMPEDE
MODEL 3608
VXL
BRUSHLESS



BANDIT
MODEL 2408
VXL
BRUSHLESS

Velineon
EXTREME BRUSHLESS POWER SYSTEM

INTRODUCTION

- 3 BEFORE YOU PROCEED
- 4 SAFETY PRECAUTIONS
- 5 TOOLS, SUPPLIES AND REQUIRED EQUIPMENT
- 6 ANATOMY OF THE RUSTLER VXL
- 7 ANATOMY OF THE STAMPEDE VXL
- 8 ANATOMY OF THE BANDIT VXL
- 9 QUICK START: GETTING UP TO SPEED
- 10 GLUING TIRES AND DECORATING YOUR MODEL
- 11 THE TRAXXAS TQ RADIO AND VELINEON BRUSHLESS POWER SYSTEM
- 19 ADJUSTING THE ELECTRONIC SPEED CONTROL
- 21 DRIVING YOUR MODEL
- 22 BASIC TUNING ADJUSTMENTS
- 24 MAINTAINING YOUR MODEL
- 25 TROUBLESHOOTING
- 26 ADVANCED TUNING ADJUSTMENTS

Thank you for purchasing a Traxxas electric model equipped with the new Velineon™ Brushless Power System. This manual covers the Rustler® VXL Stadium race truck, the Bandit™ VXL buggy, and the Stampede® VXL monster truck. The Velineon Power System lets you experience the best that brushless motor technology has to offer. Incredible speed, efficient operation, long run times, and low-maintenance operation are just some of the benefits. No matter which model you have selected, we are confident you will be rewarded with high-speed performance in a durable, long-lasting product.

This manual contains the instructions you will need to operate, and maintain your model so that you can enjoy it for years to come. We want you to feel confident that you own one of the best-performing models in the market and that it is backed by a team of professionals who aim to provide the highest level of factory support possible. Traxxas models are about experiencing total performance and satisfaction, not just with your model, but also with the company that stands behind it.

We know you're excited about getting your new model on the road, but it's very important that you take some time to read through the Owners Manual. This manual contains all the necessary set-up and operating procedures that will allow you to unlock the performance potential that Traxxas engineers designed into your model. Also be sure to read and follow the precautions and warnings in this manual and on any labels or tags attached to your model. They are there to educate you on how to operate your model safely and also get maximum life and performance from your model.

Even if you are an experienced R/C enthusiast, it's important to read and follow the procedures in this manual.

Thank you again for going with Traxxas. We work hard every day to assure you receive the highest level of customer satisfaction possible. We truly want you to enjoy your new model!

Traxxas Support

Traxxas support is with you every step of the way. Refer to the next page to find out how to contact us and what your support options are.



Quick Start

This manual is designed with a Quick Start path that outlines the necessary procedures to get your model up and running in the shortest time possible. If you are an experienced R/C enthusiast you will find it helpful and fast. Be sure and read through the rest of the manual to learn about important safety, maintenance, and adjustment procedures. Turn to page 9 to begin.



BEFORE YOU PROCEED

Carefully read and follow all instructions in this and any accompanying materials to prevent serious damage to your model. Failure to follow these instructions will be considered abuse and/or neglect.

Before running your model, look over this entire manual and examine the model carefully. If for some reason you decide it is not what you wanted, then do not continue any further. **Your hobby dealer absolutely cannot accept a model for return or exchange after it has been run.**

WARNINGS, HELPFUL HINTS, & CROSS-REFERENCES

Throughout this manual, you'll notice warnings and helpful hints identified by the icons below. Be sure to read them!



An important warning about personal safety or avoiding damage to your model and related components.



Special advice from Traxxas to make things easier and more fun.



Refers you to a page with a related topic.

SUPPORT

If you have any questions about your model or its operation, call the Traxxas Technical Support line toll-free at: **1-888-TRAXXAS (1-888-872-9927)***

Technical support is available Monday through Friday from 8:30am to 9:00pm central time. Technical assistance is also available at www.Traxxas.com/support. You may also e-mail customer support with your question at support@Traxxas.com. Join thousands of registered members in our online community at Traxxas.com.

Traxxas offers a full-service, on-site repair facility to handle any of your Traxxas service needs. Maintenance and replacement parts may be purchased directly from Traxxas by phone or online at www.BuyTraxxas.com. You can save time, along with shipping and handling costs, by purchasing replacement parts from your local dealer.

Do not hesitate to contact us with any of your product support needs. We want you to be thoroughly satisfied with your new model!

Traxxas
1100 Klein Road
Plano, Texas 75074
Phone: 972-265-8000
Toll-free 1-888-TRAXXAS

Traxxas U.K.
P.O. Box 1128
Winterbourne, Bristol
BS36-2SH
England
Phone: 44-117-956-1002

Internet
www.Traxxas.com
E-mail: support@Traxxas.com

Entire contents ©2007 Traxxas. Traxxas, Ready-To-Race, Ready-To-Win, Rustler, Bandit, Stampede Velineon and ProGraphix are trademarks or registered trademarks of Traxxas. Other brand names and marks are the property of their respective holders and are used only for purposes of identification. No part of this manual may be reproduced or distributed in print or electronic media without the express written permission of Traxxas. Specifications are subject to change without notice.

SAFETY PRECAUTIONS



All instructions and precautions outlined in this manual should be strictly followed to ensure safe operation of your model.



This model is not intended for use by children under 8 years of age without the supervision of a responsible and knowledgeable adult. Gearing and battery choice (see *LiPo Batteries, right*) effect the skill level of the model. See chart below.



Gearing: Stock Pinion
Battery: 6-Cell NiMH
Voltage*: 7.2V
mAh: 3000+Mah



Gearing: Opt. Pinion
Battery: 7-Cell NiMH
Voltage*: 8.4V
mAh: 4000+Mah



Gearing: Opt. Gearing
Battery: 3S 20C LiPo
Voltage*: 11.1V
mAh: 4000+ mAh



Gearing: Opt. Gearing
Battery: 3S 20C LiPo
Voltage*: 11.1V
mAh: 8000 mAh

*Nominal

See the gearing chart on page 26 for more information.



All of us at Traxxas want you to safely enjoy your new model. Operate your model sensibly and with care, and it will be exciting, safe, and fun for you and those around you. Failure to operate your model in a safe and responsible manner may result in property damage and serious injury. The precautions outlined in this manual should be strictly followed to help ensure safe operation. You alone must see that the instructions are followed and the precautions are adhered to.

IMPORTANT POINTS TO REMEMBER

- ⚠ Your model is not intended for use on public roads or congested areas where its operation can conflict with or disrupt pedestrian or vehicular traffic.
- ⚠ Never, under any circumstances, operate the model in crowds of people. Your model is very fast and could cause injury if allowed to collide with anyone.
- ⚠ Because your model is controlled by radio, it is subject to radio interference from many sources that are beyond your control. Since radio interference can cause momentary losses of radio control, always allow a safety margin in all directions around the model in order to prevent collisions.
- ⚠ The motor, battery, and speed control can become hot during use. Be careful to avoid getting burned.
- ⚠ Don't operate your model at night, or anytime your line of sight to the model may be obstructed or impaired in any way.
- ⚠ **Most importantly, use good common sense at all times.**

BATTERIES AND BATTERY CHARGING

Your model uses rechargeable batteries that must be handled with care for safety and long battery life. Make sure to read and follow all instructions and precautions that were provided with your battery packs and your charger. It is your responsibility to charge and care for your battery packs properly. In addition to your battery and charger instructions, here are some more tips to keep in mind.

- ⚠ Never leave batteries to charge unattended.
- ⚠ Remove the batteries from the model while charging.
- ⚠ Always unplug the battery from the electronic speed control when the model is not in use and when it is being stored or transported.
- ⚠ Allow the battery packs to cool off between runs (before charging).
- ⚠ Do not use battery packs that have been damaged in any way.
- ⚠ Do not use battery packs that have damaged wiring, exposed wiring, or a damaged connector.
- ⚠ Children should have responsible adult supervision when charging and handling batteries.

LiPo Batteries

Lithium Polymer (LiPo) batteries are becoming popular for use in R/C models due to their compact size, high energy density, and high-current output. However, these types of batteries require special care and handling

procedures for long life and safe operation. **Warning:** LiPo batteries are intended only for advanced users that are educated on the risks associated with LiPo battery use. **Traxxas does not recommend that anyone under the age of 16 use or handle LiPo battery packs without the supervision of a knowledgeable and responsible adult.**

Your model is able to use LiPo batteries with nominal voltage not to exceed 11.1 volts (3S packs) volts. LiPo batteries have a minimum safe discharge voltage threshold that should not be exceeded. The Velineon VXL-3s electronic speed control is equipped with built-in Low-Voltage Detection that alerts the driver when LiPo batteries have reached their minimum voltage (discharge) threshold. **It is the driver's responsibility to stop immediately to prevent the battery pack from being discharged below its safe minimum threshold.**

Low-Voltage Detection on the speed control is just one part of a comprehensive plan for safe LiPo battery use. **It is critical for you, the user, to follow all other instructions supplied by the battery manufacturer and the charger manufacturer for proper charging, use, and storage of LiPo batteries. Make sure you understand how to use your LiPo batteries.** Be aware that Traxxas shall not be liable for any special, indirect, incidental, or consequential damages arising out of the installation and/or use of LiPo batteries in Traxxas models.

If you have questions about LiPo battery usage, please consult with your local hobby dealer or contact the battery manufacturer. As a reminder, all batteries should be recycled at the end of their useful life. Do not throw batteries away in the trash. Ask your hobby dealer for the location of the closest recycling center or go online to www.rbc.org (Rechargeable Battery Recycling Corporation) to find a recycling center near you.

SPEED CONTROL

- ⚠ Water and Electronics Do Not Mix: Do not operate the model in or around water. Never allow water, moisture, or other foreign materials to get inside the speed control.
- ⚠ Disconnect the Batteries: Always disconnect the battery pack from the speed control when not in use.
- ⚠ Transmitter on First: Switch on your transmitter first before switching on the speed control to prevent runaways and erratic performance.
- ⚠ Don't Get Burned: The heat sink can get extremely hot, so be careful not to touch it until it is cool. Supply adequate airflow for cooling.
- ⚠ Use Stock Connectors: If you decide to change the battery or motor connectors, only change one battery or motor connector at a time. This will prevent damage from accidentally mis-wiring the speed control. Please note that modified speed controls can be subject to a rewiring fee when returned for service. Removing the battery connector on the speed control or using the same-gender connectors on the speed control will void the product's warranty.
- ⚠ Insulate the Wires: Always insulate exposed or damaged wiring with heat shrink tubing to prevent short circuits

TOOLS, SUPPLIES AND REQUIRED EQUIPMENT

Your model comes with a set of specialty metric tools. You'll need to purchase other items, available from your hobby dealer, to operate and maintain your model.

SUPPLIED TOOLS AND EQUIPMENT



2.5mm "L" wrench



2.0mm "L" wrench



1.5mm "L" wrench



Turnbuckle wrench



U-joint wrench

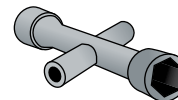

4-way wrench



Optional Pinion Gear *see page 26*

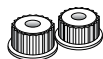

Aftermarket servo adapters



Pre-load spacers and shock pistons (on parts tree) *see page 22*



Body clips and body washers



Battery hold-down pad (to reduce battery vibration, if necessary)

REQUIRED TOOLS AND EQUIPMENT (SOLD SEPARATELY)



8 AA alkaline batteries



6 or 7-cell NiMH battery pack with Traxxas High-Current Connector



NiMH battery charger (peak detecting type recommended) *see sidebar*



Charging adapter - Traxxas part #3061 (if your battery charger has a Molex connector)



For more information on batteries, see *Use the Right Batteries* on page 15.



A peak-detecting charger is recommended for best performance and longest battery life. For more information, see *Use the Right Charger* on page 12.
Important: If you plan to use LiPo battery packs, you will need to purchase a charger specially made to charge Lithium Polymer batteries. See the warnings on page 4 about LiPo batteries.



Recommended Equipment

These items are not required for the operation of your model, but are a good idea to include in any R/C toolbox:

- Safety glasses
- Thin, hobby-quality cyanoacrylate instant tire glue (CA glue)
- Hobby knife
- Side cutters and/or needle nose pliers
- Philips screwdriver
- Soldering iron

ANATOMY OF THE RUSTLER VXL

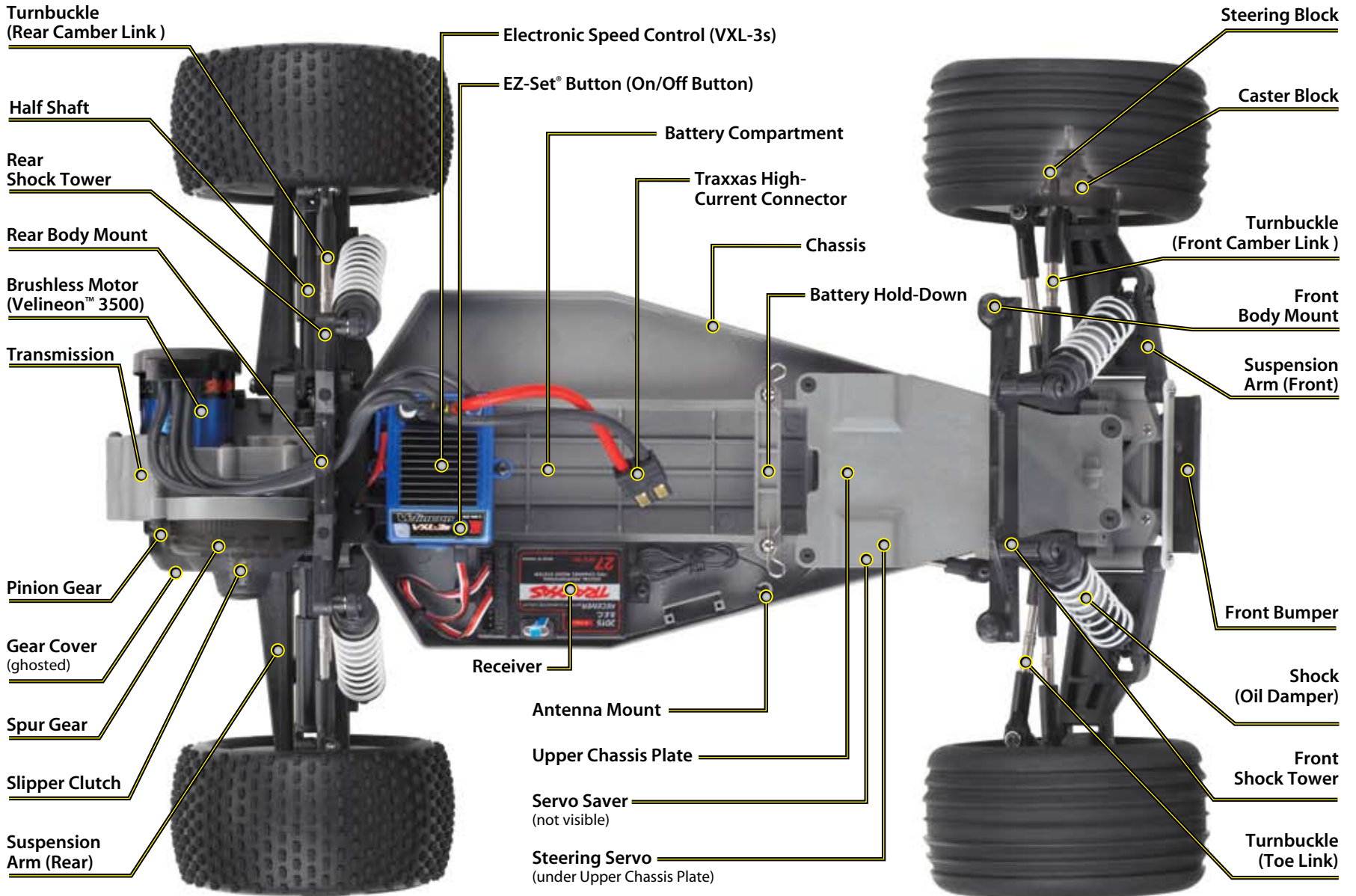

ANATOMY OF THE STAMPEDE

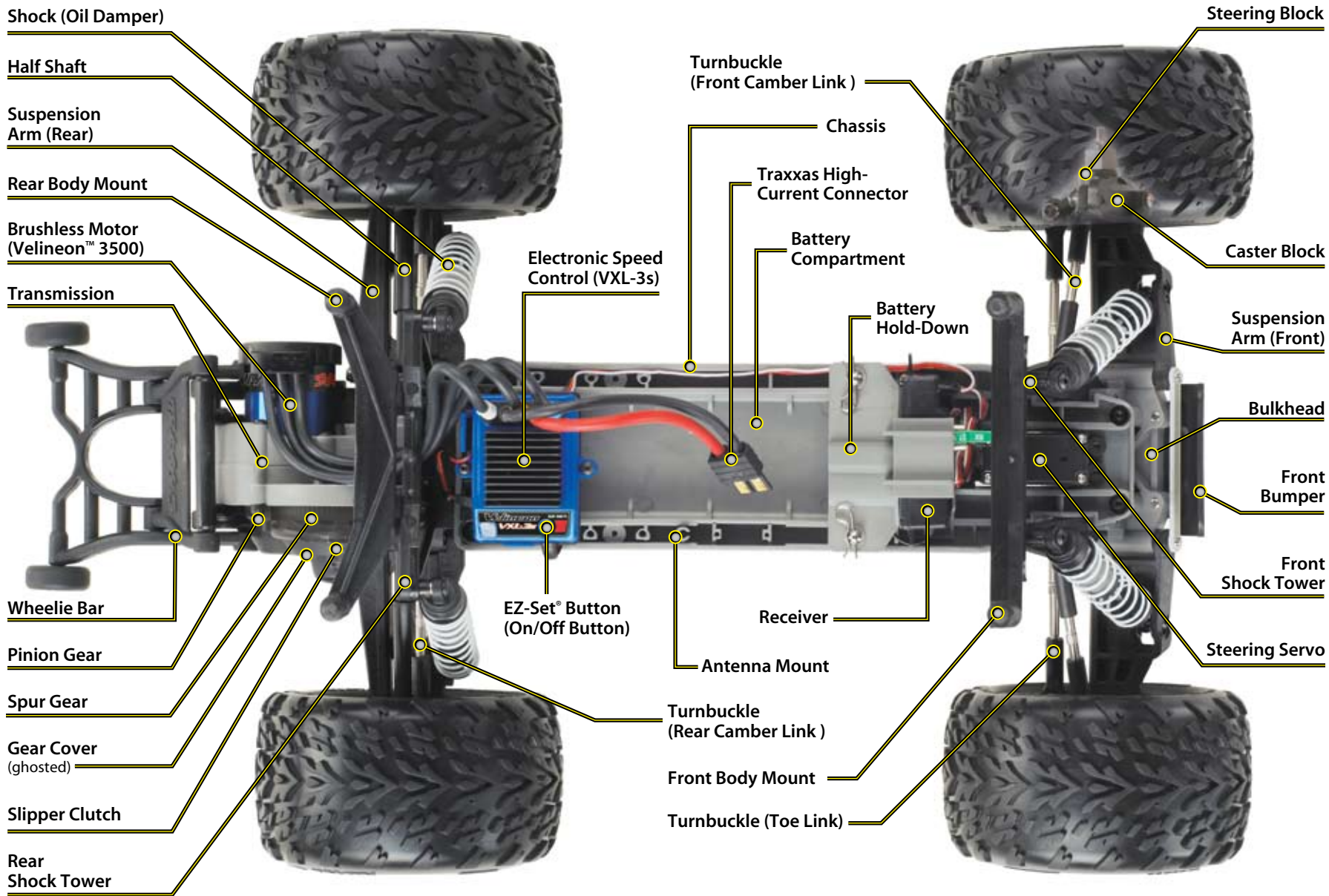

ANATOMY OF THE BANDIT

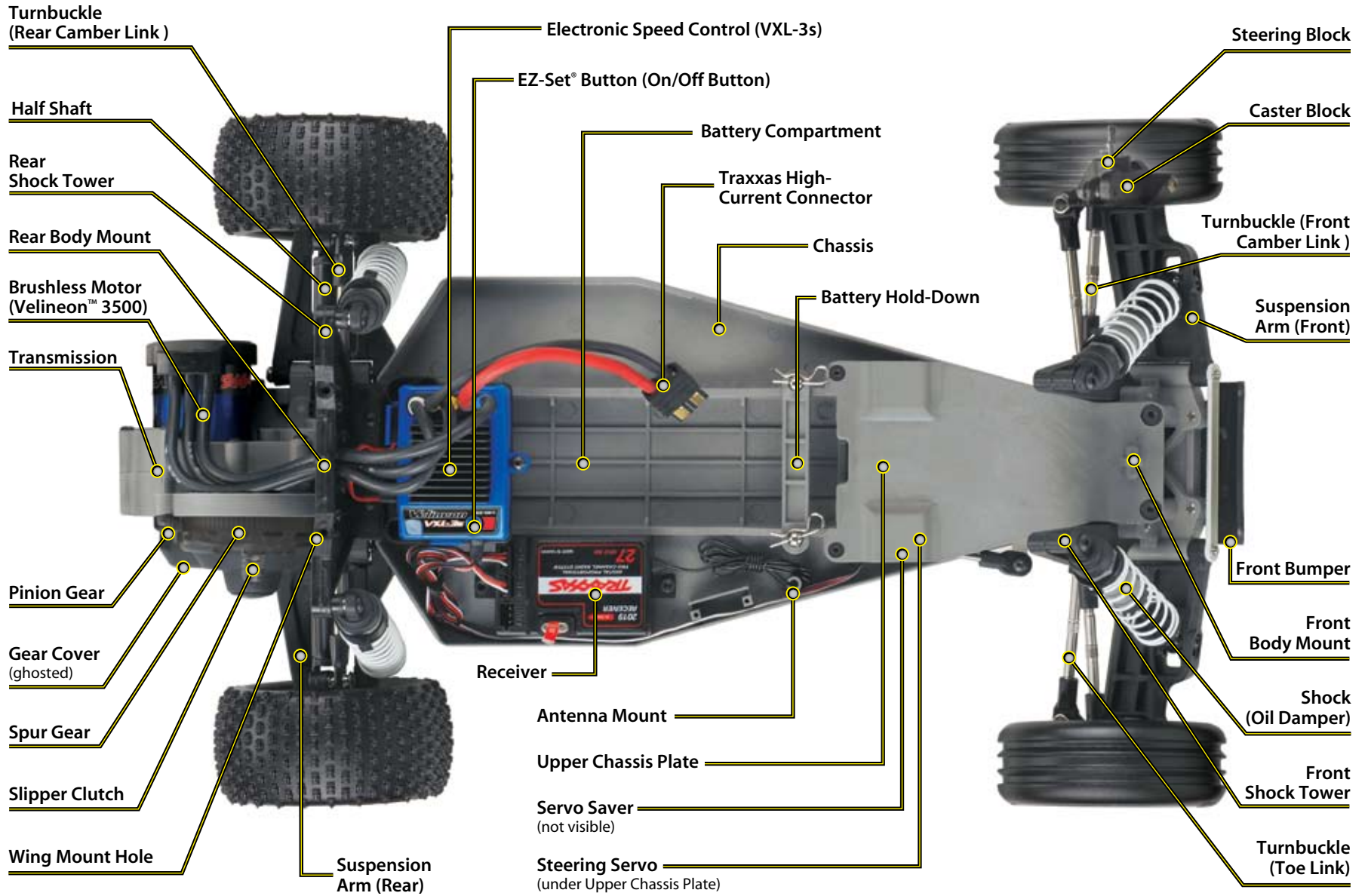

QUICK START: GETTING UP TO SPEED

The following guide is an overview of the procedures for getting your model running. Look for the Quick Start logo on the bottom corners of Quick Start pages.

1. Read the safety precautions on page 4

For your own safety, understand where carelessness and misuse could lead to personal injury.

9. Detail your model • See page 10

Apply other decals if desired.

2. Charge the battery pack • See sidebar, page 12

Fully charge a battery pack (not included). Charge your battery now so it will be ready when you finish the other setup procedures.

10. Drive your model • See page 21

Driving tips and adjustments for your model.

3. Install the antenna • See page 16

Install the antenna mast in the model.

11. Maintaining your model • See page 24

Follow these critical steps to maintain the performance of your model and keep it in excellent running condition.

4. Install batteries in the transmitter • See page 15

The transmitter requires 8 AA alkaline or rechargeable batteries.

5. Install the battery pack in the model • See page 15

Your model requires a fully charged battery pack (not included).

6. Turn on the radio system • See page 18

Make a habit of turning the transmitter on first, and off last.

7. Check servo operation • See page 18

Make sure the steering servo is working correctly.

8. Range test the radio system • See page 18

Follow this procedure to make sure your radio system works properly at a distance and that there is no interference from outside sources.



The Quick Start Guide is not intended to replace the full operating instructions available in this manual. Please read this entire manual for complete instructions on the proper use and maintenance of your model.

Look for the Quick Start logo at the bottom of Quick Start pages.



GLUING TIRES AND DECORATING YOUR MODEL

APPLYING THE DECALS

The main decals for your model have been applied at the factory. The decals are printed on self-adhesive clear mylar and are die-cut for easy removal. Use a hobby knife to lift the corner of a decal and lift it from the backing. To apply the decals, place one end down, hold the other end up, and gradually smooth the decal down with your finger as you go. This will prevent air bubbles. Placing both ends of the decal down and then trying to smooth it out will result in air pockets. Look at the photos on the box for typical decal placement.

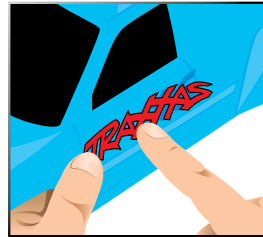

TIRE GLUING

The factory tires on your model are already glued to the rims. The tires must be glued to the rims to prevent the rims from spinning inside the tires. The instructions here are provided to show you how to glue replacement tires to the rims in the future. Use CA tire glue available from your local hobby dealer.

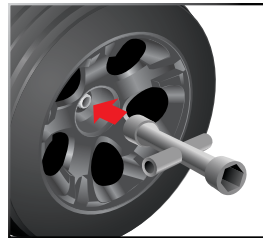

1. Remove a wheel from your model using the 4-way wrench.
2. Use your thumb to push the side of the tire away from the rim. Place one or two drops of CA glue into the opening and release the tire. Capillary action will draw the glue around the bead of the tire.
3. Repeat step two at four or five points around the rim, until the tire is completely secured to the rim. Turn the rim over and repeat the process for the inside of the rim/tire. Repeat for the other three wheels.
4. Reinstall the wheels. Make sure none of the axle pins have fallen out from behind the hex hubs.

INSTALLING THE BANDIT VXL WING

The Bandit VXL wing comes pre-installed. The instructions here are to show you how to install a replacement wing in the future.

1. Locate the wing, wing buttons, wing wire, and two 3mm set screws.
2. Use masking tape to protect the bottom of the painted wing from scratches when installing the wing wire. Cut a hole in the tape for the wing buttons and push the aluminum wing buttons through the holes.
3. Carefully insert the wing wire through the holes in the wing buttons. Secure the wing wire by installing the 3mm set screws into the wing buttons.
4. Make sure the ends of the wing wire are perpendicular to the bottom of the wing. If necessary, bend the wing wire so the ends are perpendicular to the bottom of the wing.
5. Insert the wing through the holes in the body and into the holes in the top of the shock tower. If the wing is loose, spread the ends of the wire out so that the wing fits tighter in the holes. Adjust the wing by bending it up or down, as required.

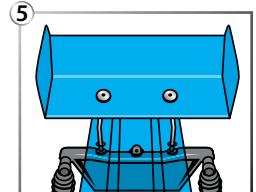
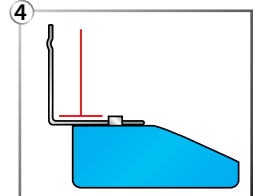
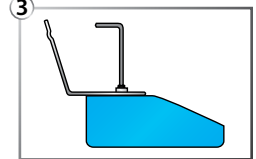
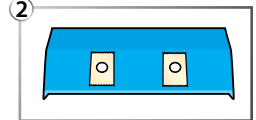
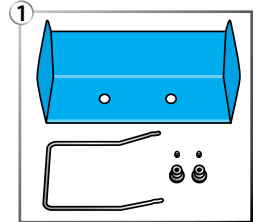

THE TRAXXAS TQ RADIO AND VELINEON BRUSHLESS POWER SYSTEM

Your model is equipped with the Traxxas TQ Radio System. The Traxxas TQ Radio System is a 2-channel system that provides high-power output up to a quarter mile. Your model uses one servo and an electronic speed control.

TQ TRANSMITTER

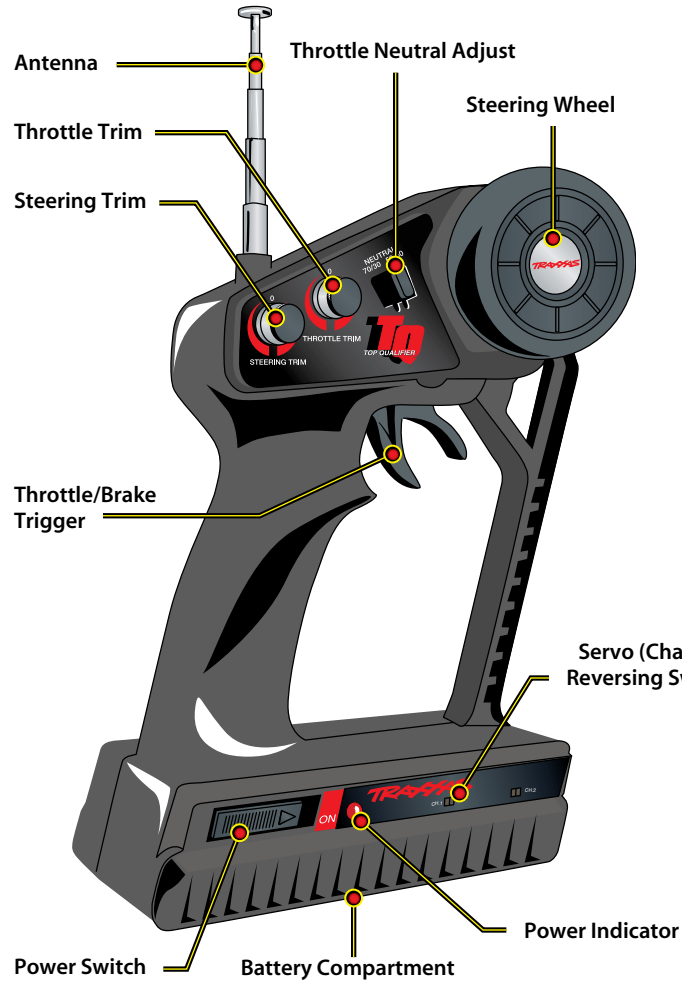

MODEL WIRING DIAGRAM

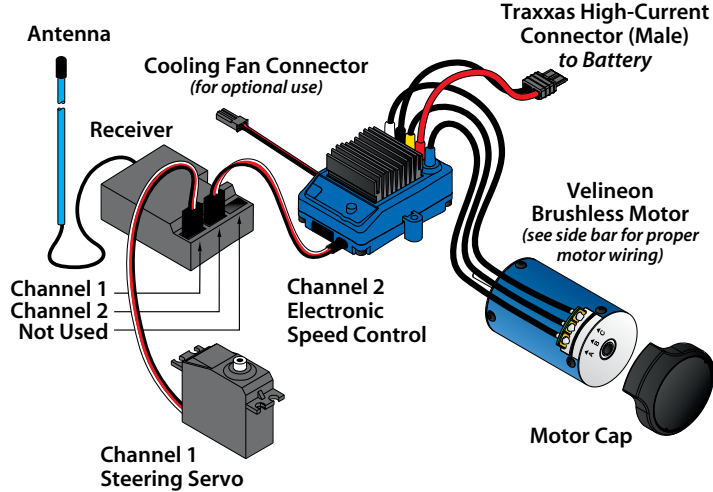

VXL-3S ELECTRONIC SPEED CONTROL

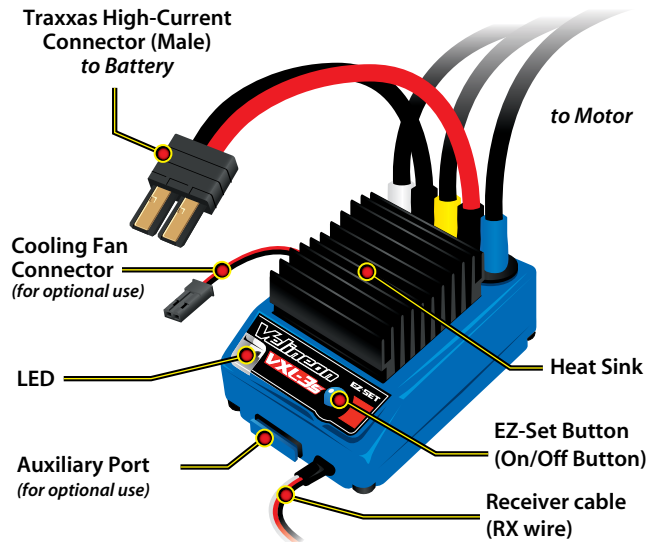

ESC/Motor Wiring Diagram

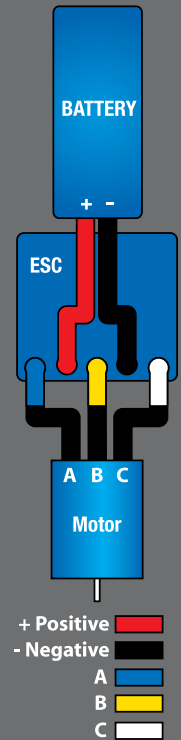



Use the Right Charger

The most convenient type of charger is an AC peak-detecting charger that plugs directly into an AC wall outlet. It contains special peak-detection circuitry that automatically shuts the charger off when the battery is fully charged.

If you're using a 15-minute timed charger, always fully discharge NiMH battery packs before each charge. Some high mAh battery packs (1500 mAh or higher) require more than the standard 15 minutes of charge time. If the battery pack is cold after 15 minutes of charging, add another 5 minutes of charge time. Closely monitor the battery pack and stop charging when it begins to feel warm to the touch. Never leave a battery charging unattended. Always follow charger manufacturer's instructions.

For Lithium Polymer batteries, only use a charger designed for LiPo batteries. See LiPo battery warnings on page 4.









RADIO AND POWER SYSTEM TERMINOLOGY

Please take a moment to familiarize yourself with these radio and power system terms. They will be used throughout this manual.

BEC (Battery Eliminator Circuit) - The BEC can either be in the receiver or in the ESC. This circuit allows the receiver and servos to be powered by the main battery pack in an electric model. This eliminates the need to carry a separate pack of 4 AA batteries to power the radio equipment.

Brushless Motor - A D/C brushless motor replaces the brushed motor's traditional commutator and brush arrangement with intelligent electronics that energize the electromagnetic windings in sequence to provide rotation. Opposite of a brushed motor, the brushless motor has its windings (coils) on the perimeter of the motor can and the magnets are mounted to the spinning rotor shaft.

Channel - The 27 MHz frequency band is divided into 6 channels so that up to six models can be operated simultaneously. Each channel is referred to by its flag color and channel number, as shown below.

CHANNEL	FREQUENCY BAND	FLAG COLOR	TRAXXAS PART NO.
 1	26.995	BROWN	2031
 2	27.045	RED	2032
 3	27.095	ORANGE	2033
 4	27.145	YELLOW	2034
 5	27.195	GREEN	2035
 6	27.255	BLUE	2036

Clearing your frequency - A routine, verbal check to make sure nobody else in your area is operating on the same channel. Always clear your frequency by calling out your channel number before operating your model. Wait or move to another area if your channel is already being used.

Cogging - Cogging is a condition sometimes associated with brushless motors. Typically it is a slight stutter noticed when accelerating from a stop. It happens for a very short period as the signals from the electronic speed control and the motor synch with each other. The VXL-3s electronic speed control is optimized to virtually eliminate cogging.

Crystal (X-tal) - The plug-in device that determines which channel the radio system will operate on. For each channel, there are two crystals, one for the receiver and one for the transmitter. Of those two crystals, the one marked with the lower number (.455 MHz lower) must be inserted into the receiver.

Current - Current is a measure of power flow through the electronics, usually measured in amps. If you look at wire like a garden hose, current is a measure of how much water is flowing through the hose.

ESC (Electronic Speed Control) - An electronic speed control is the electronic motor control inside the model. The VXL-3s electronic speed control uses advanced circuitry to provide precise, digital proportional throttle control. Electronic speed controls use power more efficiently than mechanical speed controls so that the batteries run longer. An electronic speed control also has circuitry that prevents loss of steering and throttle control as the batteries lose their charge.

Frequency band - The radio frequency used by the transmitter to send signals to your model. All Traxxas RTR models operate on a 27 MHz frequency band.

kV Rating - Brushless motors are often rated by their kV number. The kV rating equals no-load motor rpm with 1 volt applied. The kV increases as the number of wire turns in the motor decreases. As the kV increases, the current draw through the electronics also increases. The Velineon 3500 motor is a 10-turn, 3500 kV motor optimized for the best speed and efficiency in lightweight 1/10 scale models.

LiPo - Abbreviation for Lithium Polymer. Rechargeable LiPo battery packs are known for their special chemistry that allows extremely high energy density and current handling in a compact size. These are high performance batteries that require special care and handling. For advanced users only.

mAh - Abbreviation for milliamp hour. A measure of the capacity of the battery pack. The higher the number, the longer the battery will last between recharges.

Neutral position - The standing position that the servos seek when the transmitter controls are at the neutral setting.

NiCad - Abbreviation for nickel-cadmium. The original rechargeable hobby pack, NiCad batteries have very high current handling, high capacity, and can last up to 1000 charging cycles. Good charging procedures are required to reduce the possibility of developing a "memory" effect and shortened run times.

NiMH - Abbreviation for nickel-metal hydride. Rechargeable NiMH batteries offer high current handling, and much greater resistance to the "memory" effect. NiMH batteries generally allow higher capacity than NiCad batteries. They can last up to 500 charge cycles. A peak charger designed for NiMH batteries is required for optimal performance.

Receiver - The radio unit inside your model that receives signals from the transmitter and relays them to the servos.

Resistance - In an electrical sense, resistance is a measure of how an object resists or obstructs the flow of current through it. When flow is constricted, energy is converted to heat and is lost. The Velineon power system is optimized to reduce electrical resistance and the resulting power-robbing heat.

Rotor - The rotor is the main shaft of the brushless motor. In a brushless motor, the magnets are mounted to the rotor, and the electromagnetic windings are built into the motor housing.

Sensored - Sensored refers to a type of brushless motor that uses an internal sensor in the motor to communicate rotor position information back to the electronic speed control. The VXL-3s electronic speed control is able to use sensed motors when applications benefit from them (such as some sanctioned racing classes).

Sensorless - Sensorless refers to a brushless motor that uses advanced instructions from an electronic speed control to provide smooth operation. Additional motor sensors and wiring are not required. The VXL-3s electronic speed control is optimized for smooth sensorless control.

Servo - Small motor unit in your model that operates the steering mechanism.

Solder Tabs - Accessible, external contacts on the motor that allows for easy wire replacement. The Velineon 3500 is equipped with solder tabs.

Transmitter - The hand-held radio unit that sends throttle and steering instructions to your model.

Trim - The fine-tuning adjustment of the neutral position of the servos, made by adjusting the throttle and steering trim sliders on the face of the transmitter.

Thermal Shutdown Protection - Temperature sensing electronics used in the VXL-3s electronic speed control detect overloading and overheating of the transistor circuitry. If excessive temperature is detected, the unit automatically shuts down to prevent damage to the electronics.

2-channel radio system - The TQ radio system, consisting of the receiver, the transmitter, and the servos. The system uses two channels: one to operate the throttle and one to operate the steering.

Voltage - Voltage is a measure of the electrical potential difference between two points, such as between the positive battery terminal and ground. Using the analogy of the garden hose, while current is the quantity of water flow in the hose, voltage corresponds to the pressure that is forcing the water through the hose.



The following Traxxas High Current Connector packages are available from your hobby dealer. When using adapters, be careful not to exceed the current rating of the Molex connector.

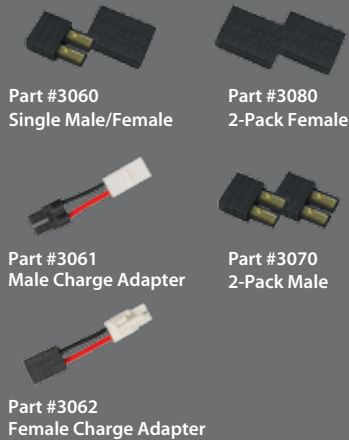

POWER SYSTEM BATTERIES

Your model is equipped with a state of the art, high-performance power system. It is designed to be able to flow large amounts of power with least amount of restriction. The benefits are drastically increased speed and acceleration. However, this places extra demands on the battery and electrical system connections.

The Traxxas High Current Connector

Your model is equipped with the Traxxas High-Current Connector. Standard connectors restrict current flow and are not capable of delivering the power needed to maximize the output of the Velineon Brushless Power system.



The Traxxas connector's gold-plated terminals with a large contact surfaces ensure positive current flow with the least amount of resistance. Secure, long-lasting, and easy to grip, the Traxxas connector is engineered to extract all the power your battery has to give.

To run this model, your batteries must be equipped with Traxxas High-Current Connectors. Batteries can either be purchased new with Traxxas connectors installed or Traxxas connectors can be purchased to install on battery packs you already own. See sidebar for packages available from your hobby dealer.

Battery Pack Construction

The Velineon Brushless Power System is designed to be able to flow large amounts of current from the battery in order to make the power and performance you expect. For best performance, your model requires the use of NiMH battery packs that have cells rated for high discharge and use high-quality, low-resistance assembly techniques. Cheaply made battery packs do not retain their performance characteristics after repeated uses in high-powered electric applications. They will lose their punch and run time and may require frequent replacement. In addition, poor-quality, high-resistance cell connectors could fail, requiring disassembly and repair. The main goal is to reduce all sources of high resistance in the pack. This includes the connector, the wire, and the bars attaching the cells together. High pack resistance will create additional heat and rob you of the full power the cells are capable of producing.

When choosing NiMH battery packs, look for the following:

Wire: The VXL-3s electronic speed control is equipped with 12-gauge wire. For optimum performance, the battery pack should also be equipped with 12-gauge wire. The minimum allowable wire size is 14-gauge. Look for flexible wiring to prevent the possibility of breakage, split insulation, and short circuits.

Construction: Battery construction is very important in achieving low pack resistance. The lowest resistance assembly method is the side-by-side cell configuration which uses thick copper bars soldered directly to the battery cells. Make sure these types of packs are fully encased in shrink wrap to prevent the danger of exposed battery terminals.

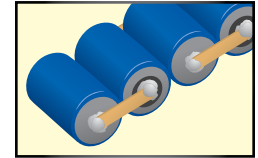

Side-by-side cells

Stick style packs (end-to-end cell configuration) are much more common. Stick packs typically use thin spot welded Nickel strips to connect the cells. Look for the thickest metal strips (about the thickness of a business card) and many spot welds at each connection.

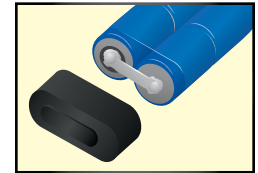

Stick pack (end cap removed)

For 7-cell hump style packs make sure that the 7th cell is connected with 12 or 14-gauge wire or thick copper battery bars. If the 7th cell is connected using the thin Nickel strips, there will be too much resistance and the pack may fail due to high current flow.

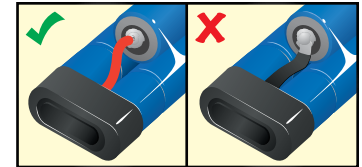

12-gauge wire

Nickel bar (ribbon wire)

Connector: The typical Molex style connector is inadequate for use in your model. It creates resistance that becomes a bottleneck to current flow. **If your battery pack is equipped with a Molex connector, it must be replaced with a Traxxas High-Current Connector to mate with the VXL-3s electronic speed control.**



Molex connector

INSTALLING TRANSMITTER BATTERIES

Your TQ transmitter uses 8 AA batteries. The battery compartment is located in the base of the transmitter.

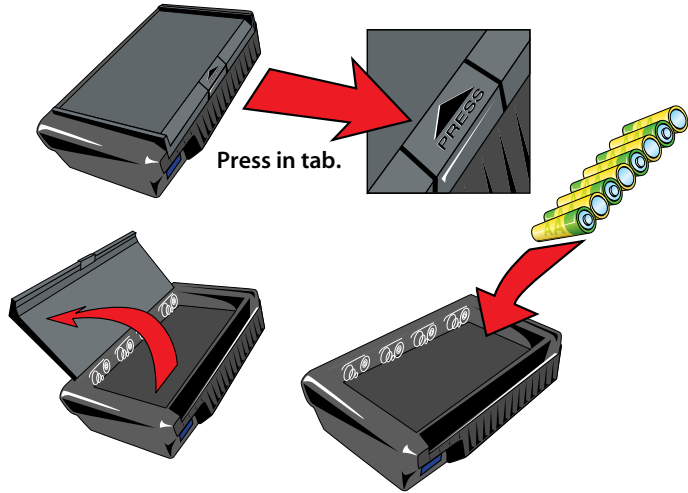

1. Remove the battery compartment door by pressing the tab and lifting the door up.
2. Install the batteries in the correct orientation as indicated in the battery compartment.
3. Reinstall the battery door and snap it closed.
4. Turn on the transmitter and check the power indicator for a solid red light.

If the power indicator light flashes, then the transmitter batteries are weak, discharged or possibly installed incorrectly. Replace with new or freshly charged batteries. The power indicator light does not indicate the charge level of the battery pack installed in the model.

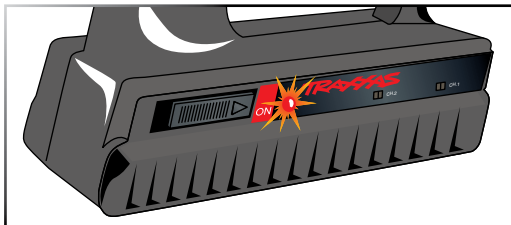

Installing the Battery Pack

Place the battery pack into the battery compartment of the model and then place the battery hold-down over the posts. Secure the battery hold-down with body clips in the holes in the posts. Do not connect the battery pack yet. **Note:** A piece of foam is installed in the back of the battery compartment to keep smaller battery packs secure. The foam may be removed to accommodate larger battery packs. **Stampede note:** The battery wire should route under the hump in the battery hold-down. Make sure the receiver is secured by the battery hold-down.

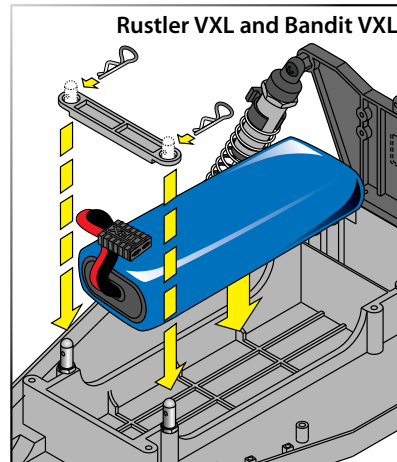
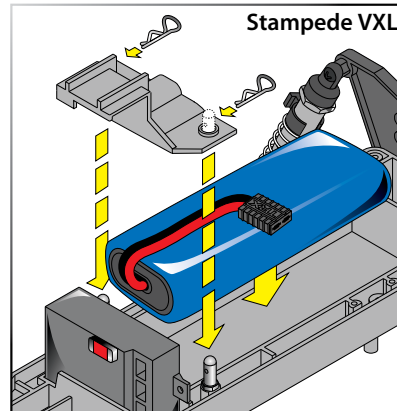

Use the Right Batteries

Your transmitter uses AA batteries. Use new alkaline batteries, or rechargeable batteries such as NiMH (Nickel Metal Hydride) batteries in your transmitter. Make sure rechargeable batteries are fully charged according to the manufacturer's instructions.

If you use rechargeable batteries in your transmitter, be aware that when they begin to lose their charge, they lose power more quickly than regular alkaline batteries.

Caution: Discontinue running your model at the first sign of weak batteries (flashing red light on the transmitter) to avoid losing control.



If the power indicator doesn't light red, check the polarity of the batteries. Check rechargeable batteries for a full charge.



Use hump packs for 7-cell installation (see your hobby dealer)



Spray a little window cleaner on the antenna wire to make it easier to push through the antenna tube.



If there are any kinks in the black antenna wire, it will be more difficult to push through the antenna tube. Pull the wire straight by sandwiching it between your thumb and index finger and running your fingers along the length of the wire (with medium pressure).



Don't shorten the length of the antenna wire. Its length is tuned to the frequency band; cutting it could severely shorten the radio system's range.



Don't push the transmitter antenna down from the top. Pull it down from the bottom, one segment at a time, to prevent binding and kinking the antenna mast.



Stampede VXL

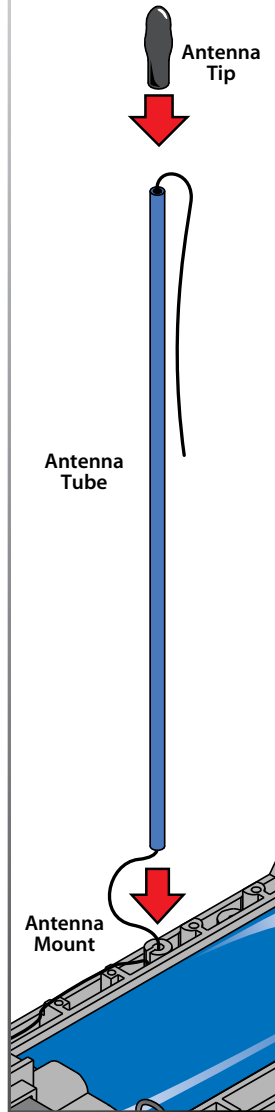

SETTING UP THE ANTENNA

You must install the antenna mast (tube) before you operate your model. You'll find the plastic antenna tube and tip in the bag with your manuals and documentation.

1. Locate the black antenna wire that exits the receiver.
2. Pull the wire straight with your fingers several times until it is straight (no kinks or bends) and then insert the end of the wire into one end of the antenna tube. Push the wire all the way through the antenna tube.
3. Pull the remaining wire through the antenna tube, and then insert the base of the antenna tube into the molded post on the chassis.
4. Fold the remaining antenna wire over the top of the tube and secure it with the antenna tip.
5. On the transmitter, always fully extend the telescoping antenna when running your model. Make a habit of holding the transmitter so that the antenna points straight up.

Rustler VXL and Bandit VXL

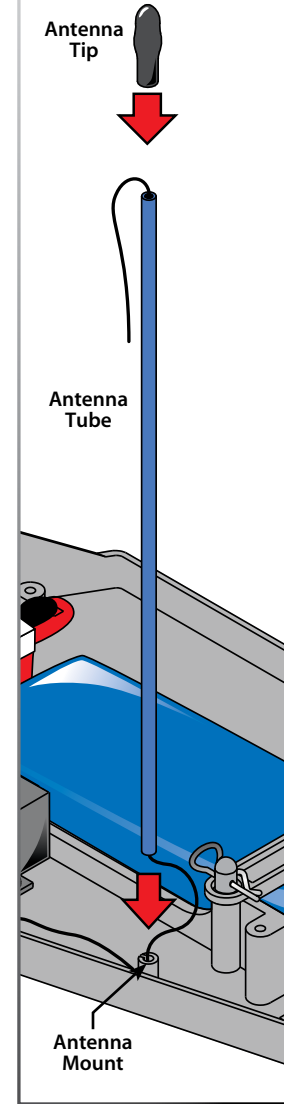

TQ RADIO SYSTEM CONTROLS



TQ RADIO SYSTEM ADJUSTMENTS

In addition to the electronic throttle and steering trim controls, your radio system features throttle neutral adjustment and servo reversing switches. **These are preset at the factory and should not require further adjustment.**

Throttle Neutral Adjustment

The throttle neutral adjustment is located on the transmitter face and controls the forward/reverse travel of the throttle trigger. Change the adjustment by pressing the button and sliding it to the desired position.

There are two settings available:
50/50: Allows equal travel for both acceleration and reverse (default).
70/30: Allows more throttle travel (70%) and less reverse/brake travel (30%).

Note: If you change throttle travel, you will need to reprogram the electronic speed control.

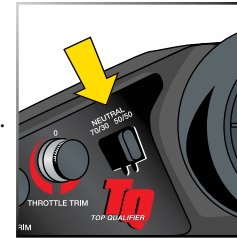

Electronic Throttle Trim

The electronic throttle trim located on the face of the transmitter adjusts the neutral (center) point of the electronic speed control. This control has been preset for you at the factory.

Electronic Steering Trim

The electronic steering trim located on the face of the transmitter adjusts the neutral (center) point of the steering servo when the servo is at rest. Adjust this control to make the model drive straight with no steering input at the wheel.

Servo Reversing Switches

The servo reversing switches are located on the front of the transmitter, next to the on/off switch. Moving a switch reverses the direction of the corresponding servo.

Each switch corresponds to a channel, as shown below. For example, if you turn the steering wheel to the right and your wheels turn left, you would move the Channel 1 switch to correct the servo direction. It may be necessary to adjust the corresponding trim control after moving a switch.

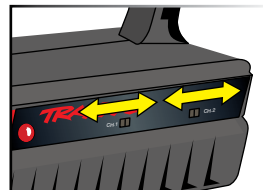

Channel	Servo
1	Steering
2	Throttle

Default Setting



Using Reverse: While driving, move the throttle trigger forward to apply brakes. Once stopped, return the throttle trigger to neutral. Push the throttle trigger forward again to engage proportional reverse.



Remember, always turn the TQ transmitter on first and off last to avoid damage to your model.



Your speed control was adjusted to the radio from the factory. It is possible for the throttle trim control on the transmitter to have moved during transit or while handling the transmitter. If the motor runs when the model is switched on, then move the throttle trim control on the transmitter until the motor stops. If anything more than a slight adjustment of the throttle trim control is required, then you should readjust your speed control. Refer to the adjustments section on page 19.



When rechargeable batteries begin to lose their charge, they will fade much faster than alkaline dry cells. Stop immediately at the first sign of weak batteries. Never turn the transmitter off when the battery pack is plugged in. The model could run out of control.



TQ RADIO SYSTEM RULES

- Each time you prepare to run your model, you must clear your frequency to be sure no one else in the area is using the same channel as you. There are six possible channels, numbered 1 through 6. Each is represented by a color. Look at the crystal plugged into the back of your transmitter to determine which channel your model is assigned to.
- Always turn your TQ transmitter on first and off last. This procedure will help to prevent your model from receiving stray signals from another transmitter, or other source, and running out of control.
- Always have the transmitter turned on before plug in the battery.
- Always use new or freshly charged batteries for the radio system. Weak batteries will limit the range of the radio signal between the receiver and the transmitter. Loss of the radio signal can cause you to lose control of your model.

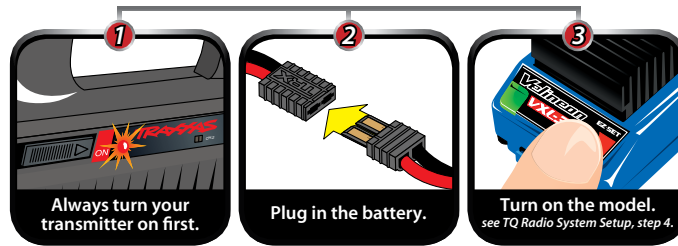

TQ RADIO SYSTEM SETUP

The TQ Radio System was pre-adjusted at the factory. The adjustment should be checked, before running the model, in case of movement during shipping. Here's how:

1. Fully extend the chrome antenna mast on the transmitter and turn the switch on. The red indicator light on the transmitter should be solid red (not flashing).
2. Elevate the model on a block or a stand so that the rear tires are off the ground. Make sure your hands are clear of the moving parts of the model.
3. Plug the battery pack in the model into the speed control.

4. The on/off switch is integrated into the speed control. With the transmitter on, press and release the EZ-Set button (.25 seconds). The LED will shine GREEN (see warning, below). This turns the model on. To turn the VXL-3s off, press and hold the EZ-Set button until the green LED turns off (.5 seconds). **Warning: If the LED shines red, Low-Voltage Detection is off.** Never use LiPo batteries while Low-Voltage Detection is turned off. The default factory setting is for Low-Voltage Detection to be on (LED shines green). See page 19 for more information.
5. Turn the steering wheel on the transmitter back and forth and check for rapid operation of the steering servo. Also, check that the steering mechanism is not loose or binding. If the steering operates slowly, check for weak batteries.
6. When looking down at model, the front wheels should be pointing straight ahead. If the wheels are turned slightly to the left or right, slowly adjust the steering trim control on the transmitter until they are pointing straight ahead.
7. Gently operate the throttle trigger to ensure that you have forward and reverse operation, and that the motor stops when the throttle trigger is at neutral. **Warning: Do not apply full throttle in forward or reverse while the model is elevated.**
8. Once adjustments are made, turn off your model, followed by the hand held transmitter.

RANGE-TESTING THE TQ RADIO SYSTEM

Before each running session with your model, you should range-test your radio system to ensure that it operates properly.

1. Turn on the radio system and check its operation as described in the previous section.
2. Elevate the model on a block or a stand so that the rear tires are off the ground. Have a friend watch the model. Make sure hands and clothing are clear of the wheels and other moving parts on the model.
3. Make sure your transmitter antenna is fully extended, and then walk away from the model with the transmitter until you reach the farthest distance you plan to operate the model.
4. Operate the controls on the transmitter once again to be sure that the model responds correctly. **Warning: Do not apply full throttle in forward or reverse while the model is elevated.**
5. Do not attempt to operate the model if there is any problem with the radio system or any external interference with your radio signal at your location.

ADJUSTING THE ELECTRONIC SPEED CONTROL

VXL-3s Battery Settings (Low-Voltage Detection Setting)

The Velineon VXL-3s electronic speed control is equipped with built-in Low-Voltage Detection. The Low Voltage Detection circuitry constantly monitors the battery voltage. When the battery voltage begins to reach the minimum recommended discharge voltage threshold for LiPo battery packs, the VXL-3s will limit the power output to 50% throttle. When the battery voltage attempts to fall below the minimum threshold, the VXL-3s will shut down all motor output. The LED on the speed control will slowly blink red, indicating a low voltage shutdown. The VXL-3s will stay in this mode until a fully charged battery is connected. The electronic speed control is factory set with Low-Voltage Detection turned on. Low-Voltage Detection can be turned off for a slight increase in run-time when using NiMH batteries. Traxxas recommends leaving Low Voltage Detection on at all times. When Low Voltage Detection interrupts driving, NiMH batteries will already be at the end of their useful charge and voltage will be decreasing rapidly.

Never use LiPo batteries while Low-Voltage Detection is turned off.

Verify that Low-Voltage Detection is turned on:

1. Turn on the transmitter (with the throttle at neutral).
2. Connect a fully charged battery pack to the VXL-3s.
3. Press and release the EZ-Set button to turn the VXL-3s on. If the LED is solid green, then Low-Voltage Detection is ON. If the LED is solid red, then the Low-Voltage Detection is OFF (not safe to use LiPo batteries).

To turn Low-Voltage Detection off (NiMH setting):

1. Make sure the LED on the VXL-3s is on and green.
2. Press and hold the EZ-Set button for ten seconds.
The LED will turn off and then light red. Also, a "falling" musical tone will be emitted from the motor.
3. Low-Voltage Detection is now OFF.

To turn Low-Voltage Detection on (LiPo setting):

1. Make sure the LED on the VXL-3s is on and red.
2. Press and hold the EZ-Set button for ten seconds.
The LED will turn off and then light green. Also, a "rising" musical tone will be emitted from the motor.
3. Low-Voltage Detection is now ON.

Transmitter Adjustments for the VXL-3s ESC

Before attempting to program your VXL-3s ESC, it is important to make sure that your transmitter is properly adjusted (set back to the factory defaults). Otherwise, you may not get the best performance from your speed control.

The transmitter should be adjusted as follows:

1. Set the throttle neutral switch to the 50/50 setting.
2. Set the throttle trim to the middle "0" setting. This sets the neutral position.
3. Set the Channel 2 servo reversing switch to the left position.

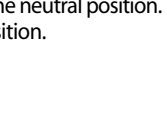
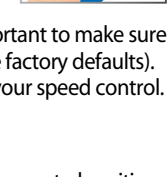
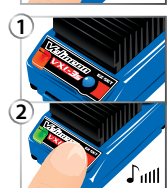
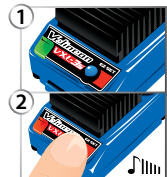

4. Do not change the position of any of the servo reversing switches after programming the VXL-3s ESC.

VXL-3s Setup Programming (Calibrating your ESC and transmitter)

Read through all of the programming steps before you begin. If you get lost during programming or receive unexpected results, simply unplug the battery, wait a few seconds, plug the battery back in, and start over.

1. Connect a fully charged battery pack to the VXL-3s.
2. Turn on the transmitter (with the throttle at neutral).
3. Press and hold the EZ-Set button (A). The LED will first turn green and then red. Release the EZ-Set button.
4. When the LED blinks RED ONCE. Pull the throttle trigger to the full throttle position and hold it there (B).
5. When the LED blinks RED TWICE. Push the throttle trigger to the full reverse and hold it there (C).
6. When the LED blinks GREEN ONCE, programming is complete. The LED will then shine green or red (depending on low-voltage detection setting) indicating the VXL-3s is on and at neutral (D).



VXL-3s Operation

To operate the speed control and test programming, place the vehicle on a stable block or stand so that all of the driven wheels are off the ground. Disconnect motor wires "A" and "C" (see page 11), this will assure the motor does not drive the wheels during testing. Do not test programming without disconnecting the motor wires.

Note that in steps 1-7 below, Low Voltage Detection is turn ON (factory default) and the LED shines green. If Low Voltage Detection is OFF, the LED will shine red instead of green in steps 1-7 below.

1. With the transmitter on, press and release the EZ-Set button. The LED will shine green. This turns the VXL-3s on.
2. Apply forward throttle. The LED will turn off until full throttle power is reached. At full throttle, the LED will illuminate green.
3. Move the trigger forward to apply the brakes. Note that braking control is fully proportional. The LED will turn off until full braking power is reached. At full brakes, the LED will illuminate green.
4. Return the throttle trigger to neutral. The LED will shine green.
5. Move the throttle trigger forward again to engage reverse (Profile #1). The LED will turn off. Once full reverse power is reached, the LED will illuminate green.
6. To stop, return the throttle trigger to neutral. Note that there is programmed delay when changing from reverse to forward. This prevents damage to the transmission on high-traction surfaces.



VXL-3s Specifications

Input voltage:

4.8-11.1V (4 to 9 cells NiMH or 2S to 3S LiPo)

Supported Motors:

Brushed
Brushless
Sensorless brushless

Motor limit:

None

Continuous current:

200A

Peak current :

320A

BEC voltage:

6.0V DC

Transistor type:

MOSFET

Battery connector:

Traxxas High-Current Connector

Motor connectors:

TRX 3.5mm bullet connectors

Motor/Battery Wiring:

12-gauge Maxx® Cable

Thermal Protection:

2-stage thermal shutdown

See page 27 for advanced VXL-3s features and setup.



Patent-Pending Training Mode (Profile #3) reduces forward and reverse throttle by 50%. Training Mode is provided to reduce the power output allowing beginning drivers to better control the model. As driving skills improve, simply change to Sport or Race Mode for full-power operation.



Tip For Fast Mode Changes
The VXL-3s is set to Profile 1 (Sport Mode) as the default. To quickly change to Profile 3 (Training Mode), with the transmitter on, press and hold the SET button until the light blinks red three times and then release. For full power, quickly change back to Profile 1 (Sport Mode) by pressing and holding the SET button until the light blinks red one time and then releasing.



The VXL-3s has built in programming that prevents accidental activation of reverse while in forward motion and vice-versa. You must come to a complete stop, release the throttle trigger, then apply opposite throttle to engage the motor in the desired direction.

7. To turn the VXL-3s off, press the EZ-Set button until the LED turns off (.5 seconds).

VXL-3s Profile Selection

The speed control is factory set to Profile #1 (100% forward, brakes, and reverse). To disable reverse (Profile #2) or to allow 50% forward and 50% reverse (Profile #3), follow the steps below. The speed control should be connected to the receiver and battery, and the transmitter should be adjusted as described previously. The profiles are selected by entering the programming mode.

Profile Description

Profile #1 (Sport Mode): 100% Forward, 100% Brakes, 100% Reverse

Profile #2 (Race Mode): 100% Forward, 100% Brakes, No Reverse

Profile #3 (Training Mode): 50% Forward, 100% Brakes, 50% Reverse

Selecting Sport Mode (Profile #1: 100% Forward, 100% Brakes, 100% Reverse)

1. Connect a fully charged battery pack to the VXL-3s and turn on your transmitter.
2. With the VXL-3s off, press and hold the EZ-Set button until the LED turns solid green, then solid red and then begins blinking red (indicating the Profile numbers).
3. When the LED blinks red once, release the EZ-Set button.
4. The LED will blink and then turn solid green (Low-Voltage Detection ON) or red (Low-Voltage Detection OFF). The model is ready to drive.

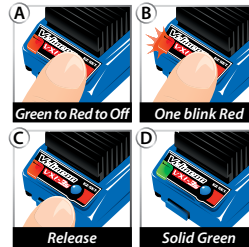

Selecting Race Mode (Profile #2: 100% Forward, 100% Brakes, No Reverse)

1. Connect a fully charged battery pack to the VXL-3s and turn on your transmitter.
2. With the VXL-3s off, press and hold the EZ-Set button until the LED turns solid green, then solid red and then begins blinking red (indicating the Profile numbers).
3. When the LED blinks red twice, release the EZ-Set button.
4. The LED will blink and then turn solid green (Low-Voltage Detection ON) or red (Low-Voltage Detection OFF). The model is ready to drive.

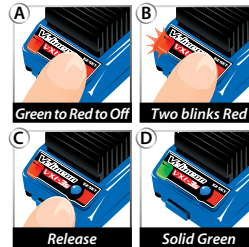

Selecting Training Mode (Profile #3: 50% Forward, 100% Brakes, 50% Reverse)

1. Connect a fully charged battery pack to the VXL-3s and turn on your transmitter.
2. With the VXL-3s off, press and hold the EZ-Set button until the LED turns solid green, then solid red and then begins

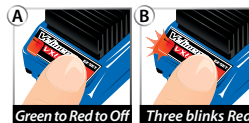

3. When the LED blinks red three times, release the EZ-Set button.
4. The LED will blink and then turn solid green (Low-Voltage Detection ON) or red (Low-Voltage Detection OFF). The model is ready to drive.

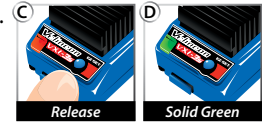

Note: If you missed the mode you wanted, keep the EZ-Set button pressed down and the blink cycle will repeat until the button is released and a Mode is selected.

LED Codes and Protection Modes

- Solid Green:** VXL-3s power on light. Low-Voltage Detection is ON (LiPo setting).
- Solid Red:** VXL-3s power on light. Low-Voltage Detection is OFF (NiCad/NiMH setting).
- Fast Blinking Red:** Thermal Shutdown Protection Stage 1. If the motor has *lower than normal power* and the VXL-3s is hot, the VXL-3s has entered **Stage 1 Thermal Shutdown Protection** to guard against overheating caused by excessive current flow. If the motor has *no power* and the VXL-3s is very hot, the VXL-3s has entered **Stage 2 Thermal Shutdown Protection** and has automatically shut down. Let the VXL-3s cool. Make sure your model is properly geared for the conditions (see page 26).
- Slow Blinking Red (with Low-Voltage Detection on):** The VXL-3s has entered **Low-Voltage Protection**. When the battery voltage begins to reach the minimum recommended discharge voltage threshold for LiPo battery packs, the VXL-3s will limit the power output to 50% throttle. When the battery voltage attempts to fall below the minimum threshold, the VXL-3s will shut down all motor output. The LED on the speed control will slowly blink red, indicating a low voltage shutdown. The VXL-3s will stay in this mode until a fully charged battery is connected.
- Alternating; Blinks Red then Green:** If the motor has *no power*, the VXL-3s has entered **Over Voltage Protection**. If a battery with too high voltage is used, the VXL-3s will go into a failsafe mode. **Warning:** If input voltage exceeds approximately 20-volts, the ESC may be damaged. Do not exceed 12.6 maximum peak input voltage.
- Blinking Green:** The VXL-3s is indicating the transmitter Throttle Trim (see page 11) is incorrectly set. Adjust the Throttle Trim to the middle "0" setting.

See page 27 for Advanced VXL-3s features.

Now it's time to have some fun! This section contains instructions on driving and making adjustments to your model. Before you go on, here are some important precautions to keep in mind.

- ⚙️ Allow the model to cool for a few minutes between runs. This is particularly important when using high capacity battery packs that allow extended periods of running. Monitoring temperatures will extend the lives of the batteries and motors. See page 27 for advanced user information on monitoring temperatures.
- ⚙️ The radio system is not waterproof. Avoid driving through puddles, mud, or snow. If water gets into the electronics it could damage them and void your warranty.
- ⚙️ Do not continue to operate the model with low batteries or you could lose control of it. Indications of low battery power include slow operation, sluggish servos (slow to return to center), or ESC shutdown due to the Low-Voltage Detection circuitry. Stop immediately at the first sign of weak batteries. When the batteries in the transmitter become weak, the red power light will begin to flash. Stop immediately and install new batteries.
- ⚙️ Do not drive the model at night, on public streets, or in large crowds of people.
- ⚙️ If the model becomes stuck against an object, do not continue to run the motor. Remove the obstruction before continuing. Do not push or pull objects with the model.
- ⚙️ Because the model is controlled by radio, it is subject to radio interference from many sources beyond your control. Since radio interference can cause momentary losses of control, allow a safety margin of space in all directions around the model in order to prevent collisions.
- ⚙️ Use good, common sense whenever you are driving your model. Intentionally driving in an abusive and rough manner will only result in poor performance and broken parts. Take care of your model so that you can enjoy it for a long time to come.
- ⚙️ When using the supplied optional pinion for top speed running, limit your driving to paved surfaces only. Running in grass and off-road could cause excessive loads on the electrical system in the model.
- ⚙️ High performance vehicles produce small vibrations which may loosen hardware over time. Frequently check wheel nuts and other screws on your vehicle to ensure that all hardware remains properly tightened.

About Run Time

A large factor affecting run time is the type and condition of your batteries. The milliamp hour (mAh) rating of the batteries determines how large their "fuel tank" is. A 3000 mAh battery pack will theoretically run twice as long as a 1500 mAh sport pack. Because of the wide variation in the types of batteries that are available and the methods with which they can be charged, it's impossible to give exact run times for the model.

Another major factor which affects run time is how the model is driven. Run times may decrease when the model is driven repetitively from a stop to top-speed and with repetitive hard acceleration.

Tips for Increasing Run Time

- ⚙️ Use batteries with the highest mAh rating you can purchase.
- ⚙️ Use a high-quality peak-detecting charger.
- ⚙️ Use the correct Low-Voltage Detection setting for your battery (see page 19). Low-Voltage Detection can be off for maximum NiMH battery runtime. Never use LiPo batteries while Low-Voltage Detection is turned off.
- ⚙️ Read and follow all maintenance and care instructions provided by the manufacturer of your batteries and charger.
- ⚙️ Keep the VXL-3s cool. Get plenty of airflow across the ESC heat sinks.
- ⚙️ Lower your gear ratio. Installing a smaller pinion or larger spur gear will lower your gear ratio, causing less power draw from the motor and battery, and reducing overall operating temperatures.
- ⚙️ Maintain your model. Do not allow dirt or damaged parts to cause binding in the drivetrain. Keep the motor clean.

mAh Ratings and Power Output

The mAh rating of the battery can effect your top speed performance. The higher capacity battery packs experience less voltage drop under heavy load than low mAh rated packs. The higher voltage potential allows increased speed until the battery begins to become discharged.



All of the toe links are installed on the truck so the left hand thread indicators point to the same direction. This makes it easier to remember which way to turn the wrench to increase or decrease toe link length (the direction is same at all four corners). Note that the groove in the hex indicates the side of the toe link with the left-hand threads.

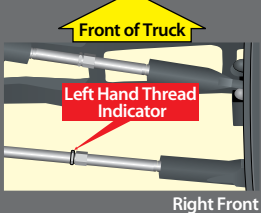
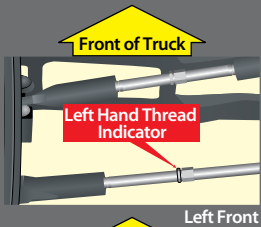

Once you become familiar with driving your model, you might need to make adjustments for better driving performance

Adjusting Gear Mesh

Incorrect gear mesh is the most common cause of stripped spur gears. To set the gear mesh, cut a narrow strip of notebook paper and run it into the gear mesh. Loosen the motor screws and slide the motor and pinion gear into the spur gear. Retighten the motor screws and then remove the strip of paper. You should be able to run a fresh strip of paper through the gears without binding them.

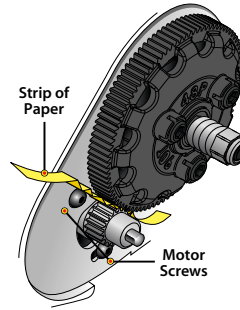

Adjusting the Toe-in

Geometry and alignment specs play an important roll in your model's handling. Take the time to set them correctly. Set the steering trim on your transmitter to neutral. Now, adjust your servo and tie rods so that both wheels are pointing straight ahead and are parallel to each other (0-degrees toe-in). This will ensure the same amount of steering in both directions.

For increased stability add one- to two-degrees of toe in to each front wheel. Use the turnbuckles to adjust the alignment.

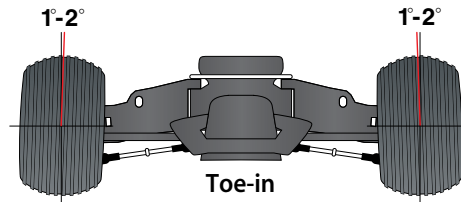

Adjusting the Camber

The camber angle of both the front and rear wheels can be adjusted with the camber rods (upper turnbuckles). Use a square or right-angle triangle to set the camber accurately. Adjust the front wheels to 0 degrees of camber (wheel perpendicular to the ground). In the rear, adjust the wheels to 1

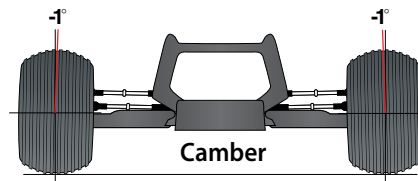

to 2 degrees of negative camber. These adjustments should be set with the truck positioned at its normal ride height.

Fine Tuning the Shocks

The four shocks on the model greatly influence its handling. Whenever you rebuild your shocks, or make any changes to the pistons, springs or oil, always make changes to them in pairs (front or rear). Piston selection depends on the range of oil viscosities that you have available. For example, using a two-hole piston with a lightweight oil will, at one point, give you the same damping as a three-hole piston with heavier oil. We recommend using the two-hole pistons with a range of oil viscosities from 10W to 50W (available from your hobby shop). The thinner viscosity oils (30W or less) flow more smoothly and are more consistent, while thicker oils provide more damping. Use only 100% pure silicone shock oil to prolong seal life. The model's ride height can be adjusted by adding or removing the clip-on, spring pre-load spacers. Adjust the ride height so that the suspension arms are slightly above being parallel to the ground. Observe how the model handles in turns. Proper set-up will add stability and help prevent spin outs. Experiment with different springs and shock oils to find what works best for your current track conditions.

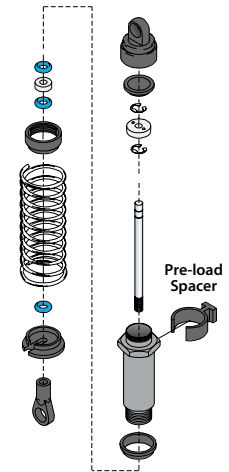

Wheels and Tires

Many types of aftermarket tires and wheels can be adapted for use on your model. Most will affect the overall width and the suspension geometry of the model. The offsets and dimensions designed into the model's wheels are intentional; therefore, Traxxas cannot recommend the use of other non-Traxxas wheels with different specifications. The diameter of the wheels is an innovative design, and there are a variety of different tires available for you to experiment with in addition to the included tires on the model (listed in your parts list). Experimentation with different types of tires is recommended to see which ones work the best on the terrain where the model is run. When selecting tires, consider the overall diameter and the rubber compound (hard or soft). If the overall diameter of the tire is significantly increased, you will need to use a smaller pinion gear to compensate for the larger tire. Soft compound tires with many short spikes generally work better

on hard, dry surfaces. In loose dirt, a tire with large spikes should perform better. See your parts list for accessory wheels and tires.

Adjusting the Slipper Clutch

The model is equipped with an adjustable slipper clutch which is built into the large spur gear. The purpose of the slipper clutch is to regulate the amount of power sent to the rear wheels to prevent tire spin. When it slips, the slipper clutch makes a high-pitch, whining noise. Remove the rubber slipper clutch plug on the transmission cover in order to adjust the slipper.

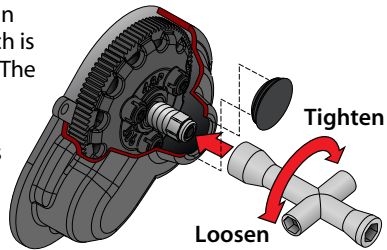

Use the 4-way wrench to turn the adjusting nut clockwise to tighten and counter-clockwise to loosen. Place the model on a high-traction surface, such as carpet. Adjust the slipper so that you can hear it slip for approximately two feet from a standing, full throttle start. (Learn more about adjusting the slipper clutch in the sidebar.)

Centering Your Servo

If the trim controls on your transmitter seem off, you may need to recenter your servo. Additionally, whenever your servo has been removed for service or cleaning, it must be re-centered prior to installation in the model.

1. Disconnect the servo horn from the steering servo.
2. Connect the steering servo to channel 1 on the receiver. Connect the electronic speed control (ESC) to channel 2. The white wire on the servo lead is positioned towards the crystal.
3. Place fresh "AA" batteries in the transmitter and turn the transmitter power switch on.
4. Turn the throttle and steering trim adjustments on the transmitter to the center "0" position.
5. Disconnect motor wires "A" and "C" (see page 11). Connect a fresh battery pack to the speed control and turn on the ESC (see page 18). The servo will automatically jump to its center position. The servo horn may now be installed onto the servo output shaft.
6. Check servo operation by turning the steering wheel back and forth to ensure that the mechanism has been centered properly and you have equal throw in both directions. Repeat 1-6 if necessary.

Stampede VXL Wheelie Bar Set-up

The Traxxas wheelie bar comes standard with the Stampede VXL. It is available as a bolt-on accessory (Part #3678) for the Rustler VXL and Bandit VXL. See your local hobby dealer for more information.

Changing the position of the wheelie bar height setting is easiest when installed on the vehicle. To set the position, unsnap the upper arms from the cross bars of the lower arms. Move the upper arms to the desired location, and then snap the arms together.

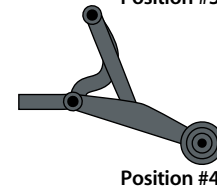
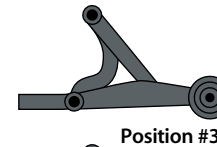
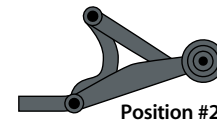
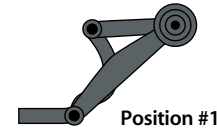
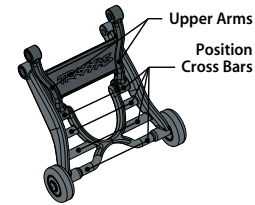

Pos. #1: The highest angle of the wheels (lowest position on the cross bars). Allows the vehicle to tip back the most for longer wheelies.

Pos. #4: The lowest angle of the wheels (highest position on the cross bars). Provides the flattest launches, reducing the chance of a wheelie.

Note: Each setting can offer different results based on the individual ride height and droop settings of a particular vehicle. Try to avoid riding on the wheelie bar wheels during normal driving (this can happen in the lowest setting with lower than stock ride heights).



To achieve a good starting point for the slipper clutch in these models, tighten the slipper clutch adjusting nut clockwise until the slipper clutch adjusting spring fully collapses (do not over tighten), and then turn the slipper clutch nut counter-clockwise one full turn.

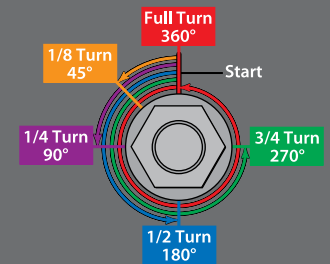

Do not run your model with the slipper clutch adjusting spring fully compressed. The minimum recommended slipper clutch setting is 1/2 turn counter-clockwise from fully compressed.



Always wear eye protection when using compressed air or spray cleaners and lubricants.



High performance vehicles generate small vibrations while driving. These vibrations may loosen hardware over time and require attention. Always check your wheel nuts and other hardware and tighten or replace when necessary.

Your model requires timely maintenance in order to stay in top running condition. **The following procedures should be taken very seriously.**

Frequently inspect the vehicle for obvious damage or wear. Look for:

1. Cracked, bent, or damaged parts
2. Check the wheels and steering for binding.
3. Check the operation of the shock absorbers.
4. Check the wiring for any frayed wires or loose connections.
5. Check the mounting of the receiver and servo(s) and speed control.
6. Check the tightness of the wheel nuts with a wrench.
7. Check the operation of the radio system, especially the condition of the batteries.
8. Check for any loose screws in the chassis structure or suspension.
9. The steering servo saver will wear out over time. If the steering becomes loose, the servo saver should be replaced.
10. Inspect the gears for wear, broken teeth, or debris lodged between the teeth.
11. Check the tightness of the slipper clutch.

Other periodic maintenance:

☞ **Slipper clutch pads**

(friction material):

Under normal use, the friction material in the slipper clutch should wear very slowly.

If the thickness of any one of the slipper clutch pads is 1.8mm or less, the friction disc should be replaced.

Measure the pad thickness using calipers or measuring against the diameter of the 1.5 and 2.0mm hex wrenches provided with the model.

☞ **Chassis:** Keep the chassis clean of accumulated dirt and grime. Periodically inspect the chassis for damage

☞ **Steering:** Over time, you may notice increased looseness in the steering system. There are several components which will wear out from use: the servo saver (Traxxas part #3744), the bellcrank bushings (Traxxas part #2545), and the tie rod ends (Traxxas part

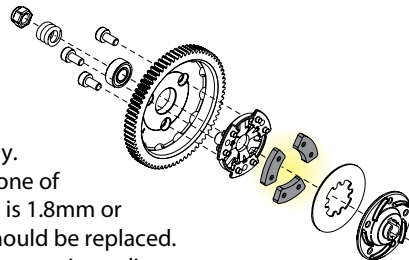

#2742). Replace these components as needed to restore factory tolerances. The bellcrank bushings (Rustler VXL and Bandit VXL only) may be replaced with 5x8mm ball bearings (Traxxas part #2728).

☞ **Shocks:** Keep the oil level in the shocks full. Use only 100% pure silicon shock oil to prolong the life of the seals. If you are experiencing leakage around the top of the shock, inspect the bladder in the top cap for signs of damage or distortion from overtightening. If the bottom of the shock is leaking, then it is time for a rebuild. The Traxxas rebuild kit for two shocks is part #2362.

☞ **Suspension:** Periodically inspect the model for signs of damage such as bent or dirty suspension pins, bent turnbuckles, loose screws, and any signs of stress or bending. Replace components as needed.

☞ **Driveline:** Inspect the driveline for signs of wear such as worn drive yokes, dirty axle half shafts, and any unusual noise or binding. If a u-joint pops apart then it is time to replace the part. Remove the gear cover and inspect the spur gear for wear and check the tightness of set screws in the pinion gears. Tighten, clean, or replace components as needed.

Storage

When you are through running the model for the day, blow it off with compressed air or use a soft bristled paint brush to dust-off the vehicle.

Always disconnect and remove the battery from the model whenever the model is stored. If the model will be stored for a long time, then also remove the batteries from the transmitter.

The following section addresses some very basic ESC and radio questions you may have about your model. Most questions arise from simple user errors or minor adjustments that are easy to correct. If you can't find a solution for your model here, then visit our website at www.Traxxas.com/support. There you will find a much more extensive and detailed online troubleshooting area. In addition, you may call Traxxas Customer Service at 1-888-TRAXXAS (outside the US call 972-265-8000).

Radio system does not work properly:

- ☞ If the power light on the transmitter does not come on, check for proper battery installation and that the batteries are new and/or fully charged. If the power light is blinking, then the transmitter batteries are weak and should be replaced. See page 15 for more details.
- ☞ If the transmitter light is on but the radio is still not responding, check for proper installation of batteries in the model and that the batteries are new and/or fully charged. Check to make sure the model is on (VXL-3s LED lit solid at neutral throttle). Check for damaged wires, a loose crystal, or loose connections. See page 15 for more details.

Short radio range:

- ☞ If the radio range appears short, then first check to make sure the transmitter antenna is fully extended and that the antenna in the model is in place and has not been cut or damaged. Next, make sure the batteries are all fully charged and check battery condition. Finally, if you are still experiencing short range, try a different location. Sometimes there can be interference from various sources that can cause your radio to malfunction.

Steering channel works but the motor will not run:

- ☞ The speed control has thermally shut down (see page 20). Allow the speed control to cool down. Use a milder motor or a smaller pinion gear. Check the drive train for restrictions. Check the motor connections. Check the motor.
- ☞ Make sure the speed control is plugged into the throttle channel of the receiver. Check operation of the throttle channel with a servo.
- ☞ Bad battery or motor. Check the operation with known good battery and motor.
- ☞ VXL-3s: Possible internal damage. Return the VXL-3s to Traxxas for service.

Steering servo does not work:

- ☞ Check the wires, radio system, crystals, battery and motor connectors, and the battery pack.
- ☞ Possible internal damage. Test the servo on channel 2 of the receiver or in another model. Return the servo to Traxxas for service.

Motor runs backwards:

- ☞ Motor wired backwards - Check the wiring and correct.

Motor runs as soon as the battery is plugged in:

- ☞ Internal damage, return VXL-3s to Traxxas for service.

VXL-3s will not go into programming mode:

- ☞ Make sure the VXL-3s is plugged into Channel 2 (the throttle channel) on the receiver. If it is plugged into the battery terminal, it will not go into programming mode.
- ☞ Be sure the VXL-3s is turned off before trying to program or select a profile.
- ☞ Unplug battery, reconnect, and repeat programming instructions on page 19.
- ☞ Check if transmitter is turned on.

Receiver glitches/throttle stutters during acceleration:

- ☞ The receiver or antenna is too close to power wires or the batteries.
- ☞ Bad connections - Check the wiring and connectors.
- ☞ Motor worn - Replace the motor.
- ☞ Excessive current to motor (over-gear motor) - Use a smaller pinion gear.
- ☞ Battery voltage low. Recharge and/or verify charged status.
- ☞ Disconnected brushless motor lead. Reconnect according to appropriate wiring diagram.

Model runs slowly / slow acceleration:

- ☞ Check the motor and battery connectors.
- ☞ Check to see if VXL-3s is in Profile #3 (50% throttle)
- ☞ Bad battery or motor. Check the operation with known good battery and motor.
- ☞ Incorrect transmitter or speed control adjustment. Refer to the "TQ Radio System Adjustments" (page 17) and "Adjusting the Electronic Speed Control" (page 19) sections.
- ☞ VXL-3s is in Thermal Shutdown Protection. Allow to cool and check for proper gearing.
- ☞ VXL-3s has entered Low-Voltage Protection (see page 20).

Model will not go in reverse:

- ☞ Make sure the throttle trim is in the correct position (LED on VXL-3s should be lit solid at neutral throttle)
- ☞ Check for correct VXL-3s profile (Profile #2 does not have reverse).
- ☞ If brushed motor is being used, verify proper connection to VXL-3s. Correct if necessary.

Keep stripping spur gears:

- ☞ Improper gear mesh, refer to "Adjusting Gear Mesh" (page 22).
- ☞ Improperly adjusted slipper clutch, refer to "Adjusting the Slipper Clutch" (page 23).

Model does not run:

- ☞ Check the radio system, battery and motor connectors, and the battery pack.
- ☞ VXL-3s has entered the second stage of Low-Voltage Protection or Thermal Shutdown Protection (see page 20).



Gearing Compatibility Chart:

The chart below shows recommended gear combination ranges when using a NiMH battery pack to power your model. In the red range, use a battery that has a continuous rating of at least 70A.

		Spur Gear			
		76	83	86	90
Pinion Gear	12	-	-	19.50	20.40
	13	-	-	18.01	18.82
	14	-	-	16.70	17.49
	15	-	15.04	15.58	16.32
	16	-	14.12	14.63	15.31
	17	-	13.27	13.76	14.39
	18	-	12.54	13.00	13.60
	19	-	11.89	12.32	12.89
	20	-	11.28	11.69	12.24
	21	-	10.75	11.14	11.66
	22	9.38	10.25	10.63	11.12
	23	8.97	9.82	10.17	10.63
	24	8.62	9.41	9.74	10.20
	25	8.27	9.03	9.36	9.79
	26	7.94	8.67	9.00	-
	27	7.64	8.35	8.67	-
	28	7.37	8.05	8.35	-
	29	7.12	7.78	8.08	-
	30	6.88	7.53	-	-
	31	6.66	7.29	-	-
	32	6.47	7.04	-	-
	33	6.26	-	-	-
	34	6.09	-	-	-
	35	5.90	-	-	-

Thick black border indicates stock settings.

Use NiMH batteries with:

- All Models
- Only Bandit VXL and Rustler VXL
- Only Bandit VXL
- Do Not Use NiMH (battery must have a continuous rating of at least 70A. Consult with your hobby dealer or battery manufacturer.)

Gearing

One of the more significant advantages to your model's transmission is the extremely wide range of available gear ratios. Changing the gearing allows you to fine tune the speed of the model and control the temperatures of the battery pack and motor. Use a lower gear ratio (numerically larger) to reduce current draw and temperatures. Use a higher gear (numerically lower) to increase top speed. Use the following formula to calculate the overall ratio for combinations not listed on the gear chart:

$$\frac{\text{\# Spur Gear Teeth}}{\text{\# Pinion Gear Teeth}} \times 2.72 = \text{Final Gear Ratio}$$

When using higher gear ratios, it is important to monitor the temperatures of the battery and motor. If the battery is extremely hot, and/or the motor is too hot to touch, your model is probably over-gearred and drawing too much current. This temperature test assumes that the model is close to factory stock weight and operates freely with no excessive friction, dragging, or binding, and the battery is fully charged and in good condition.

This model is equipped with a Velineon 3500 motor. The gear combination that comes stock on each model provides good overall acceleration and top speed. If you want more top speed install the included optional large pinion gear (more teeth). **The included optional large pinion gear is intended for high-speed running on hard surfaces, and this gearing is not recommended for off-road or repetitive starting and stopping.**

LiPo Batteries

LiPo batteries are intended only for the most advanced users that are educated on the risks associated with LiPo battery use. It is critical to follow all instructions supplied by the battery manufacturer and the charger manufacturer for proper charging, use, and storage of LiPo batteries. Make sure you understand how to use your LiPo batteries. See *Safety Precautions* and warnings on page 4 for more information.

Advanced VXL-3s Electronic Speed Control Setup

The VXL-3s electronic speed control is capable of controlling brushed, brushless, and sensored brushless motors. The VXL-3s auto-detects the motor type and has numerous built-in safeguards to prevent damage from miswiring or damaged wiring.

Sensorless brushless motors

Sensorless motors are the easiest and most reliable brushless motor type. The VXL-3s is optimized to deliver the smoothest possible sensorless motor performance. The Velineon 3500 is a sensorless brushless motor (see sidebar for specs). The wiring (phase alignment) of the motor determines its direction of rotation. Refer to the wiring diagram on page 11.

Sensored brushless motors

The VXL-3s is fully compatible with sensored brushless motors. Sensor motors use an additional sensor installed in the motor to communicate rotor position to the speed control. The VXL-3s features a covered auxiliary port that accepts aftermarket motor sensors on the front face of the unit.

Speed	Bandit VXL	35+mph	45+mph	65+mph	70mph & Beyond
	Rustler VXL	35+mph	45+mph	65+mph	70mph & Beyond
	Stampede VXL	30+mph	40+mph	60+mph	65mph & Beyond
Gearing <small>(Pinion/Spur)</small>	Bandit VXL	26/76	28/76 <small>(Included)</small>	33/76 <small>(Sold Separately)</small>	33/76 <small>(Sold Separately)</small>
	Rustler VXL	25/83	28/83 <small>(Included)</small>	31/76 <small>(Sold Separately)</small>	31/76 <small>(Sold Separately)</small>
	Stampede VXL	19/86	25/86 <small>(Included)</small>	26/86 <small>(Sold Separately)</small>	30/83 <small>(Sold Separately)</small>
Battery	6-Cell NiMH	7-Cell NiMH	3S 20C LiPo	3S 20C LiPo	
Nominal Voltage	7.2V	8.4V	11.1V	11.1V	
mAh	3000+ mAh	4000+ mAh	4000+ mAh	8000+ mAh	
Skill Level					

The VXL-3s has built-in Sensor Motor Backup Protection to prevent damage if the sensor leads or phase leads become disconnected. If a sensor lead becomes damaged or is disconnected, the VXL-3s automatically switches to sensorless brushless operation.



The VXL-3s also features Sensor Phase Detection. When a sensored brushless motor is connected, the VXL-3s will check for proper wiring. If the motor phase wiring is incorrect, the VXL-3s will not apply power to the motor until it is wired correctly.

Optional sensored brushless motor wiring diagram:

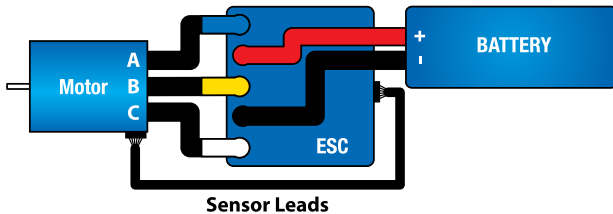

Brushed motors

For the ultimate in versatility, the VXL-3s has no motor limit when used with a brushed motor. This allows you to use any readily available 540 or 550 size brushed motors in your VXL-3s equipped vehicle. Always be sure to follow all break in and maintenance instructions set forth by the motor manufacturer. The VXL-3s automatically detects what kind of motor it is connected to so no programming actions are required to use brushed motors. Simply be sure to properly connect the motor to the speed control as shown.

Optional brushed motor wiring diagram:

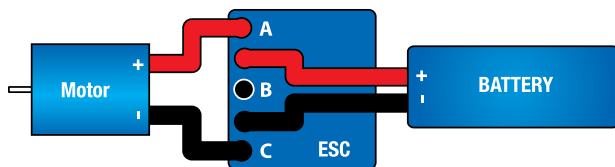

- Motor positive (+) should be connected to phase A (blue).
- Phase B is not used.
- Motor negative (-) should be connected to phase C (white).

If the wiring is reversed, the motor will operate in reverse. If the motor is wired incorrectly (using phases A+B or B+C), the VXL-3s will send short pulses to the motor and turn off the LED indicating a fail safe mode. It will not return to normal operation until wired properly.

Temperatures and Cooling

Monitoring temperatures will extend the lives of the batteries and motors. There are many options available that will help you monitor temperatures and cool your components .

Temperature gauge

An on-board temperature gauge such as the Traxxas part #4091 can aid you in monitoring your motor temperature. Generally, try to keep your motor below 200° F. If necessary, increase airflow to the motor by cutting out the rear of the body or windshield.



Heat sink cooling fan

The VXL-3s is equipped with an additional connector to supply power to an optional heat sink cooling fan. An optional heat sink cooling fan can assist in cooling the VXL-3s in high current motor applications.

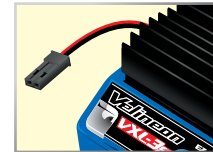

Velineon 3500 Specs

- Type: Sensorless brushless
- RPM/volt: 3500 (10-turn)
- Magnet type: Ultra High-Temperature Sintered Neodymium
- Connection type : 3.5mm bullet
- Wire size: 12 Gauge
- Current Ratings: 65A constant 100A peak/burst
- Max RPM: 50,000
- Diameter: 36mm (1.42") (540 size)
- Length: 55mm (2.165")
- Weight: 262g (9.24oz)



Always use the proper length motor bolts. Using motor bolts that are too long can interfere with the motor's rotation and damage the motor's internals!



The VXL-3s features Locked Rotor Protection. The VXL-3s checks to make sure the motor is turning. If the motor is locked or damaged, the ESC will enter fail-safe until the motor is free to rotate.



RUSTLER
STAMPEDE
BANDIT

VXL
BRUSHLESS

VXL
BRUSHLESS

VXL
BRUSHLESS

TRAXXAS

1100 KLEIN ROAD, PLANO TEXAS 75074
1-888-TRAXXAS