

MODEL 7307

TRAXXAS Rally



TRAXXAS

OWNER'S MANUAL

INTRODUCTION

- 3 BEFORE YOU PROCEED
- 4 SAFETY PRECAUTIONS
- 5 TOOLS, SUPPLIES AND REQUIRED EQUIPMENT
- 5 DECORATING YOUR MODEL
- 6 ANATOMY OF THE TRAXXAS RALLY
- 7 QUICK START: GETTING UP TO SPEED
- 8 TRAXXAS TQ 2.4GHZ RADIO & VELEON POWER SYSTEM
- 16 ADJUSTING THE ELECTRONIC SPEED CONTROL
- 18 DRIVING YOUR MODEL
- 21 TUNING ADJUSTMENTS
- 26 MAINTAINING YOUR MODEL
- 27 TQ 2.4GHZ ADVANCED TUNING GUIDE

Thank you for purchasing the Traxxas Rally. Your model is designed for high performance on asphalt, concrete, and other hard surfaces. The Rally's specially formulated tire compound and road-specific suspension settings allow it to perform exciting rally- and gymkhana-style maneuvers with precision and control. The Traxxas Rally combines proven Traxxas innovations including F1-inspired, rocker-actuated suspension, VXL brushless motor system, waterproof electronics, and a monocoque-style chassis for outstanding handling and incredible speed and power. Your Traxxas model is designed for high-performance driving, with balanced weight distribution, lightweight and high-strength materials, and the precise engineering that is the hallmark of all Traxxas vehicles.

This manual contains the instructions you will need to operate and maintain your model so that you can enjoy it for years to come. We want you to feel confident that you own one of the best-performing models in the market and that it is backed by a team of professionals who aim to provide the highest level of factory support possible. Traxxas models are about experiencing total performance and satisfaction, not just with your model, but also with the company that stands behind it.

We know you're excited about getting your new model on the road, but it's very important that you take some time to read through the Owner's Manual. This manual contains all the necessary setup and operating procedures that allow you to unlock the performance and potential that Traxxas engineers designed into your model. **Even if you are an experienced R/C enthusiast, it's important to read and follow the procedures in this manual.**

Thank you again for going with Traxxas. We work hard every day to assure you the highest level of customer satisfaction possible. We truly want you to enjoy your new model!

Traxxas Support

Traxxas support is with you every step of the way. Refer to the next page to find out how to contact us and what your support options are.

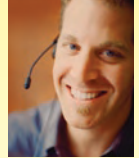

Quick Start

This manual is designed with a Quick Start path that outlines the necessary procedures to get your model up and running in the shortest time possible. If you are an experienced R/C enthusiast you will find it helpful and fast. Be sure and read through the rest of the manual to learn about important safety, maintenance, and adjustment procedures. Turn to page 7 to begin.



BEFORE YOU PROCEED

Carefully read and follow all instructions in this and any accompanying materials to prevent serious damage to your model. Failure to follow these instructions will be considered abuse and/or neglect.

Before running your model, look over this entire manual and examine the model carefully. If for some reason you decide it is not what you wanted, then do not continue any further. **Your hobby dealer absolutely cannot accept a model for return or exchange after it has been run.**

WARNINGS, HELPFUL HINTS, & CROSS-REFERENCES

Throughout this manual, you'll notice warnings and helpful hints identified by the icons below. Be sure to read them!



An important warning about personal safety or avoiding damage to your model and related components.



Special advice from Traxxas to make things easier and more fun.



Refers you to a page with a related topic.

SUPPORT

If you have any questions about your model or its operation, call the Traxxas Technical Support line toll-free at: **1-888-TRAXXAS (1-888-872-9927)***

Technical support is available Monday through Friday from 8:30am to 9:00pm central time. Technical assistance is also available at Traxxas.com. You may also e-mail customer support with your question at support@Traxxas.com. Join thousands of registered members in our online community at Traxxas.com.

Traxxas offers a full-service, on-site repair facility to handle any of your Traxxas service needs. Maintenance and replacement parts may be purchased directly from Traxxas by phone or online at BuyTraxxas.com. You can save time, along with shipping and handling costs, by purchasing replacement parts from your local dealer.

Do not hesitate to contact us with any of your product support needs. We want you to be thoroughly satisfied with your new model!

Traxxas
1100 Klein Road
Plano, Texas 75074
Phone: 972-265-8000
Toll-free 1-888-TRAXXAS

Internet
Traxxas.com
E-mail: support@Traxxas.com

Entire contents ©2010 Traxxas. Traxxas, Ready-To-Race, Ready-To-Win, Velineon, Traxxas Rally and ProGraphix are trademarks or registered trademarks of Traxxas. Other brand names and marks are the property of their respective holders and are used only for purposes of identification. No part of this manual may be reproduced or distributed in print or electronic media without the express written permission of Traxxas. Specifications are subject to change without notice.

SAFETY PRECAUTIONS



All instructions and precautions outlined in this manual should be strictly followed to ensure safe operation of your model.



This model is not intended for use by children under 14 years of age without the supervision of a responsible and knowledgeable adult.



Previous experience with radio controlled models is recommended. Models require a higher level of setup, maintenance, or support equipment.



All of us at Traxxas want you to safely enjoy your new model. Operate your model sensibly and with care, and it will be exciting, safe, and fun for you and those around you. Failure to operate your model in a safe and responsible manner may result in property damage and serious injury. The precautions outlined in this manual should be strictly followed to help ensure safe operation. You alone must see that the instructions are followed and the precautions are adhered to.

IMPORTANT POINTS TO REMEMBER

- Your model is not intended for use on public roads or congested areas where its operation can conflict with or disrupt pedestrian or vehicular traffic.
- Never, under any circumstances, operate the model in crowds of people. Your model is very fast and could cause injury if allowed to collide with anyone.
- Because your model is controlled by radio, it is subject to radio interference from many sources that are beyond your control. Since radio interference can cause momentary losses of radio control, always allow a safety margin in all directions around the model in order to prevent collisions.
- The motor, batteries, and speed control can become hot during use. Be careful to avoid getting burned.
- Don't operate your model at night, or anytime your line of sight to the model may be obstructed or impaired in any way.
- **Most importantly, use good common sense at all times.**

BATTERIES AND BATTERY CHARGING

Your model uses rechargeable batteries that must be handled with care for safety and long battery life. Make sure to read and follow all instructions and precautions that were provided with the battery pack and your charger. It is your responsibility to charge and care for the battery packs properly. In addition to your battery and charger instructions, here are some more tips to keep in mind.

- Use the supplied charger to charge the included battery. See *“Charging the Battery Pack”* on page 11.
- Never leave batteries to charge unattended.
- Remove the battery from the model while charging.
- Always unplug the battery from the electronic speed control when the model is not in use and when it is being stored or transported.
- Allow the battery pack to cool off between runs (before charging).
- Do not use battery packs that have been damaged in any way.
- Do not use battery packs that have damaged wiring, exposed wiring, or a damaged connector.
- Children should have responsible adult supervision when charging and handling batteries.

LiPo Batteries

Lithium Polymer (LiPo) batteries are becoming popular for use in R/C models due to their compact size, high energy density, and high-current output. However, these types of batteries require special care and handling procedures for long life and safe operation. **Warning:** LiPo batteries are intended only for advanced users that are educated on the risks associated with LiPo battery use. **Traxxas does not recommend that anyone under the age of 16 use or handle LiPo battery packs without the supervision of a knowledgeable and responsible adult.**

Your model is able to use LiPo batteries with nominal voltage not to exceed 11.1 volts (3S packs). LiPo batteries have a minimum safe discharge voltage threshold that should not be exceeded. The Velineon VXL-3s electronic speed control is equipped with built-in Low-Voltage Detection that alerts the driver when LiPo batteries have reached their minimum voltage (discharge) threshold. **It is the driver's responsibility to stop immediately to prevent the battery pack from being discharged below its safe minimum threshold.**

Low-Voltage Detection on the speed control is just one part of a comprehensive plan for safe LiPo battery use. **It is critical for you, the user, to follow all other instructions supplied by the battery manufacturer and the charger manufacturer for proper charging, use, and storage of LiPo batteries. Do not attempt to charge LiPo batteries with the Traxxas charger included in this package. Make sure you understand how to use your LiPo batteries.** Be aware that Traxxas shall not be liable for any special, indirect, incidental, or consequential damages arising out of the installation and/or use of LiPo batteries in Traxxas models. **If you have questions about LiPo battery usage, please consult with your local hobby dealer or contact the battery manufacturer.** As a reminder, all batteries should be recycled at the end of their useful life.

Recycling Your Traxxas Power Cell NiMH Battery

Traxxas strongly encourages you to recycle your Power Cell battery when it has reached the end of its useful life. **Do not throw your battery in the trash.** All Power Cell battery packs display the RBRC (Rechargeable Battery Recycling Corporation) icon, indicating they are recyclable. To find a recycling center near you, ask your local hobby dealer or visit www.call2recycle.org.

SPEED CONTROL

- **Disconnect the Battery:** Always disconnect the battery from the speed control when not in use.
- **Transmitter on First:** Switch on your transmitter first before switching on the speed control to prevent runaways and erratic performance.
- **Don't Get Burned:** The heat sink can get extremely hot, so be careful not to touch it until it is cool. Supply adequate airflow for cooling.
- **Use Stock Connectors:** If you decide to change the battery or motor connectors, only change one battery or motor connector at a time. This will prevent damage from accidentally mis-wiring the speed control. Please note that modified speed controls can be subject to a rewiring fee when returned for service. Removing the battery connector on the speed control or using connectors with no reverse-polarity protection on the speed control will void the product's warranty.
- **Insulate the Wires:** Always insulate exposed or damaged wiring with heat shrink tubing to prevent short circuits.
- **No Reverse Voltage:** The speed control is not protected against reverse polarity voltage. When changing the battery and/or motor, be sure to install the same type of connectors to avoid reverse polarity damage to the speed control. Removing the battery connectors on the speed control or using the same-gender connectors on the speed control will void the product's warranty.
- **No Schottky Diodes:** External Schottky diodes are not compatible with reversing speed controls. Using a Schottky diode will damage the electronic speed control and void the 30-day warranty.

TOOLS, SUPPLIES AND REQUIRED EQUIPMENT

Your model comes with a set of specialty metric tools. You'll need to purchase other items, available from your hobby dealer, to operate and maintain your model.

SUPPLIED TOOLS AND EQUIPMENT

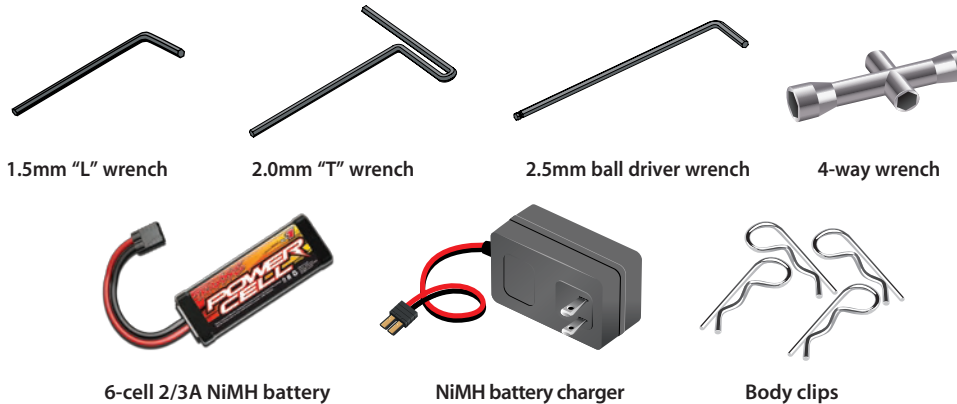

REQUIRED EQUIPMENT (SOLD SEPARATELY)



For more information on batteries, see *Use the Right Batteries* on page 11.



Recommended Equipment
These items are not required for the operation of your model, but are a good idea to include in any R/C toolbox:

- Safety glasses
- Thin, hobby-quality cyanoacrylate instant tire glue (CA glue)
- Hobby knife
- Side cutters and/or needle nose pliers
- Philips screwdriver
- Soldering iron

DECORATING YOUR MODEL

APPLYING THE DECALS

The main decals for your model have been applied at the factory. The decals are printed on self-adhesive clear mylar and are die-cut for easy removal. Use a hobby knife to lift the corner of a decal and lift it from the backing. To apply the decals, place one end down, hold the other end up, and gradually smooth the decal down with your finger as you go. This will prevent air bubbles. Placing both ends of the decal down and then trying to smooth it out will result in air pockets.

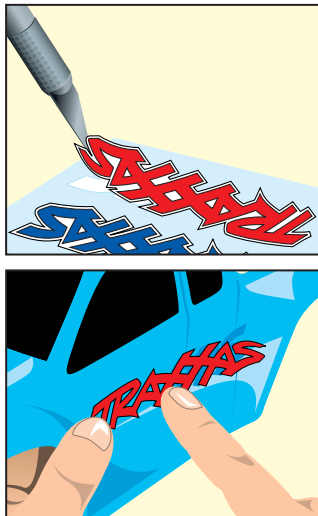

Look at the photos on the box for typical decal placement.

TIRE GLUING

The factory tires on your model are already glued to the rims. The tires must be glued to the rims to prevent the rims from spinning inside the tires. The instructions here are provided to show you how to glue replacement tires to the rims in the future. Use CA tire glue available from your local hobby dealer. You can glue the tires without removing the wheels from the model. For clarity, these instructions show the process with the wheels removed.

1. Remove a wheel from the model using the larger (7mm) end of the universal wrench.
2. Use your thumb to push the side of the tire away from the rim. Place one or two drops of CA glue into the opening and release the tire. Capillary action will draw the glue around the bead of the tire.
3. Repeat step two at four or five points around the rim, until the tire is completely secured to the rim. Turn the rim over and repeat the process for the inside of the rim/tire. Repeat for the other three wheels.
4. Reinstall the wheels, make sure none of the axle pins have fallen out from behind the hex hubs.



ANATOMY OF THE TRAXXAS RALLY

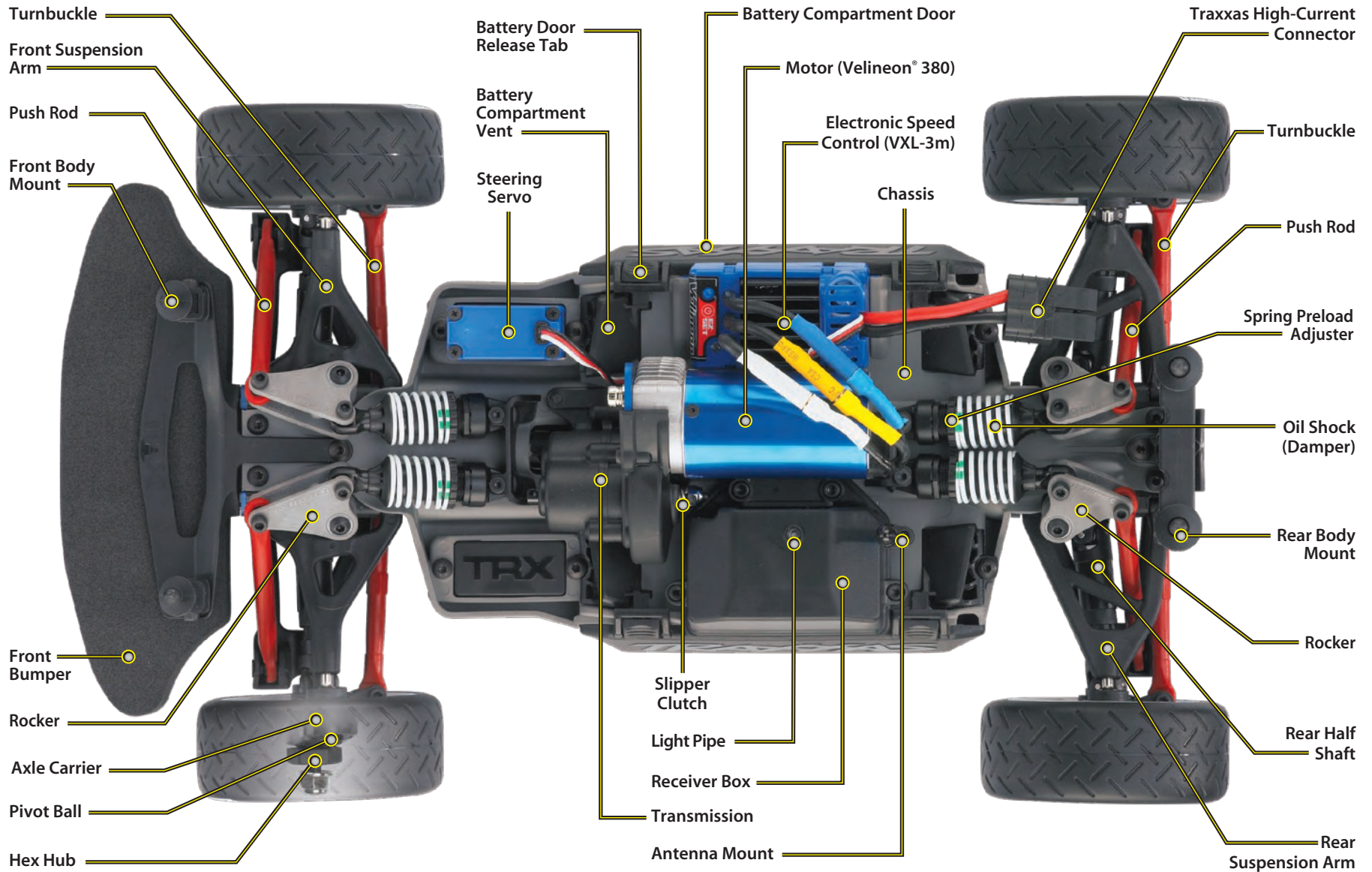

QUICK START: GETTING UP TO SPEED

 The following guide is an overview of the procedures for getting your model running. Look for the Quick Start logo on the bottom corners of Quick Start pages.

1. Read the safety precautions on page 4

For your own safety, understand where carelessness and misuse could lead to personal injury.

2. Charge the battery pack • See page 11

Fully charge the battery pack included with your model.

3. Install the antenna • See page 11

Install the antenna mast in the model.

4. Install batteries in the transmitter • See page 11

The transmitter requires 4 AA alkaline or rechargeable batteries.

5. Install the battery pack • See page 11

Install the included battery pack in your model.

6. Turn on the radio system • See page 13

Make a habit of turning the transmitter on first, and off last.

7. Check servo operation • See page 14

Make sure the steering servo is working correctly.

8. Range test the radio system • See page 14

Follow this procedure to make sure your radio system works properly at a distance and that there is no interference from outside sources.

9. Detail your model • See page 5

Apply other decals if desired.

10. Drive your model • See page 18

Driving tips and adjustments for your model.

11. Maintaining your model • See page 26

Follow these critical steps to maintain the performance of your model and keep it in excellent running condition.



The Quick Start Guide is not intended to replace the full operating instructions available in this manual. Please read this entire manual for complete instructions on the proper use and maintenance of your model.

Look for the Quick Start logo at the bottom of Quick Start pages.



INTRODUCTION

Your model includes the latest in Traxxas 2.4GHz transmitter technology. The transmitter's easy-to-use design provides instant driving fun for new R/C enthusiasts, and also offers a full compliment of pro-level tuning features for advanced users – or anyone interested in experimenting with the performance of their model. The steering and throttle channels feature adjustable Exponential, End Points, and Sub-Trims. Steering and braking Dual Rate are also available. Many of the next-level features are controlled by the Multi-Function knob, which can be programmed to control a variety functions. The detailed instructions (page 27) and Menu Tree (page 29) included in this manual will help you understand and operate the advanced functions of the new TQ 2.4GHz radio system. For additional information and how-to videos, visit Traxxas.com.

RADIO AND POWER SYSTEM TERMINOLOGY

Please take a moment to familiarize yourself with these radio and power system terms. They will be used throughout this manual. A detailed explanation of the advanced terminology and features of your new radio system begins on page 27.

2.4GHz Spread Spectrum – This model is equipped with the latest R/C technology. Unlike AM and FM systems that require frequency crystals and are prone to frequency conflicts, the TQ 2.4GHz system automatically selects and locks onto an open frequency, and offers superior resistance to interference and “glitching.”

BEC (Battery Eliminator Circuit) - The BEC can either be in the receiver or in the ESC. This circuit allows the receiver and servos to be powered by the main battery pack in an electric model. This eliminates the need to carry a separate pack of 4 AA batteries to power the radio equipment.

Brushless Motor - A D/C brushless motor replaces the brushed motor's traditional commutator and brush arrangement with intelligent electronics that energize the electromagnetic windings in sequence to provide rotation. Opposite of a brushed motor, the brushless motor has its windings (coils) on the perimeter of the motor can and the magnets are mounted to the spinning rotor shaft.

Cogging - Cogging is a condition sometimes associated with brushless motors. Typically it is a slight stutter noticed when

accelerating from a stop. It happens for a very short period as the signals from the electronic speed control and the motor synch with each other. The VXL-3m is optimized to virtually eliminate cogging.

Current - Current is a measure of power flow through the electronics, usually measured in amps. If you look at wire like a garden hose, current is a measure of how much water is flowing through the hose.

ESC (Electronic Speed Control) - An electronic speed control is the electronic motor control inside the model. Electronic speed controls use power more efficiently than mechanical speed controls so that the battery runs longer. An electronic speed control also has circuitry that prevents loss of steering and throttle control as the battery loses its charge.

Frequency band - The radio frequency used by the transmitter to send signals to your model. This model operates on the 2.4GHz direct-sequence spread spectrum.

kV Rating - Brushless motors are often rated by their kV number. The kV rating equals no-load motor rpm with 1 volt applied. The kV increases as the number of wire turns in the motor decreases. As the kV increases, the current draw through the electronics also increases.

LiPo - Abbreviation for Lithium Polymer. Rechargeable LiPo battery packs are known for their special chemistry that allows extremely high energy density and current handling in a compact size. These are high performance batteries that require special care and handling. For advanced users only.

mAh – Abbreviation for milliamp hour. A measure of the capacity of the battery pack. The higher the number, the longer the battery will last between recharges.

Neutral position - The standing position that the servos seek when the transmitter controls are at the neutral setting.

NiCad - Abbreviation for nickel-cadmium. The original rechargeable hobby pack, NiCad batteries have very high current handling, high capacity, and can last up to 1000 charging cycles. Good charging procedures are required to reduce the possibility of developing a “memory” effect and shortened run times.

NiMH - Abbreviation for nickel-metal hydride. Rechargeable NiMH batteries offer high current handling, and much greater resistance to the “memory” effect. NiMH batteries generally allow higher capacity than NiCad batteries. They can last up to 500 charge cycles. A peak charger designed for NiMH batteries is required for optimal performance.

Receiver - The radio unit inside your model that receives signals from the transmitter and relays them to the servos.

Resistance - In an electrical sense, resistance is a measure of how an object resists or obstructs the flow of current through it. When flow is constricted, energy is converted to heat and is lost. Traxxas power systems are optimized to reduce electrical resistance and the resulting power-robbing heat.

Rotor - The rotor is the main shaft of the brushless motor. In a brushless motor, the magnets are mounted to the rotor, and the electromagnetic windings are built into the motor housing.

Sensored - Sensored refers to a type of brushless motor that uses an internal sensor in the motor to communicate rotor position information back to the electronic speed control.

Sensorless - Sensorless refers to a brushless motor that uses advanced instructions from an electronic speed control to provide smooth operation. Additional motor sensors and wiring are not required.

Servo - Small motor unit in your model that operates the steering mechanism.

Solder Tabs - Accessible, external contacts on the motor that allows for easy wire replacement.

Transmitter - The hand-held radio unit that sends throttle and steering instructions to your model.

Trim - The fine-tuning adjustment of the neutral position of the servos, made by adjusting the throttle and steering trim sliders on the face of the transmitter.

Thermal Shutdown Protection - Temperature sensing electronics used in the electronic speed control detect overloading and overheating of the transistor circuitry. If excessive temperature is

detected, the unit automatically shuts down to prevent damage to the electronics.

2-channel radio system - The TQ radio system, consisting of the receiver, the transmitter, and the servos. The system uses two channels: one to operate the throttle and one to operate the steering.

Voltage - Voltage is a measure of the electrical potential difference between two points, such as between the positive battery terminal and ground. Using the analogy of the garden hose, while current is the quantity of water flow in the hose, voltage corresponds to the pressure that is forcing the water through the hose.

IMPORTANT RADIO SYSTEM PRECAUTIONS

- ☞ For maximum range, always hold the transmitter so the antenna is in a vertical position (pointing straight up). The transmitter’s antenna can be swiveled and angled to allow for a vertical position if necessary.



- ☞ Do not kink the receiver’s antenna wire. Kinks in the antenna wire will reduce range.
- ☞ DO NOT CUT any part of the receiver’s antenna wire. Cutting the antenna will reduce range.
- ☞ Extend the antenna wire in the model as far as possible for maximum range. It is not necessary to extend the antenna wire out of the body, but wrapping or coiling the antenna wire should be avoided.
- ☞ Do not allow the antenna wire to extend outside the body without the protection of an antenna tube, or the antenna wire may get cut or damaged, reducing range. It is recommended to keep the wire inside the body (in the antenna tube) to prevent the chance of damage.



To prevent loss of radio range do not kink or cut the black wire, do not bend or cut the metal tip, and do not cut the white wire at the end of the metal tip.

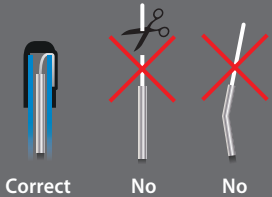

Correct

No

No

VXL-3m Wiring Diagram

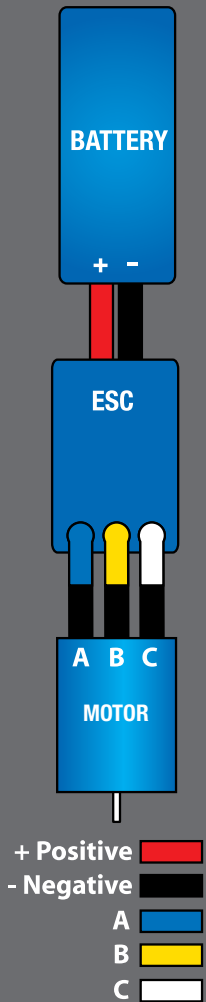

Your model is equipped with the newest Traxxas 2.4 GHz transmitter with Traxxas Link™. The transmitter has two channels for controlling your throttle and steering. The receiver inside the model has 5 output channels. Your model is equipped with one servo and an electronic speed control.

TQ 2.4GHZ TRANSMITTER

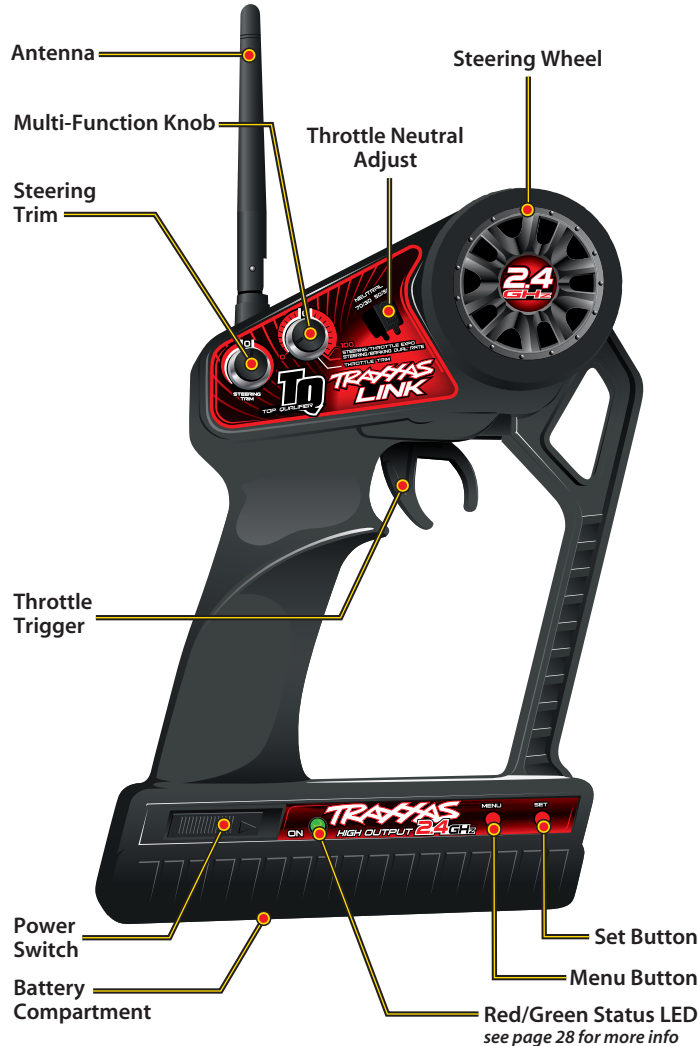

MODEL WIRING DIAGRAM

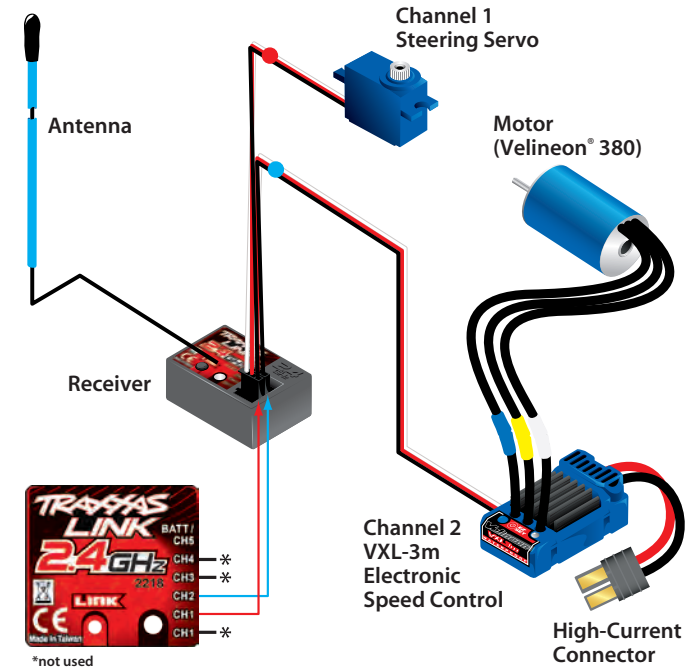

VXL-3M ELECTRONIC SPEED CONTROL

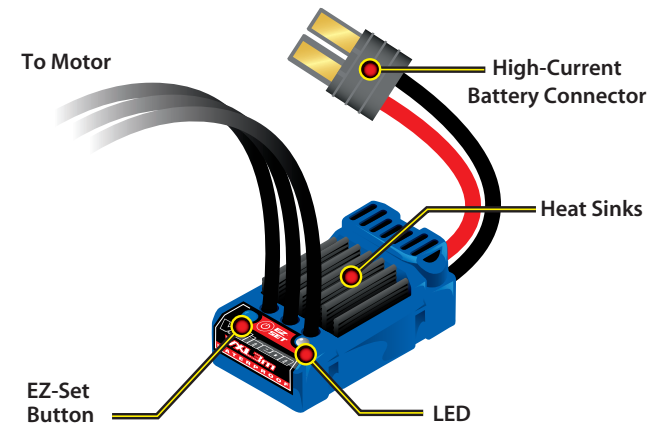

INSTALLING TRANSMITTER BATTERIES

Your TQ transmitter uses 4 AA batteries. The battery compartment is located in the base of the transmitter.

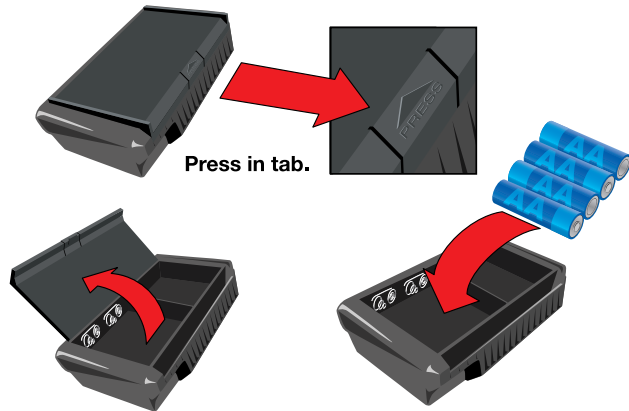

1. Remove the battery compartment door by pressing the tab and lifting the door up.*
2. Install the batteries in the correct orientation as indicated in the battery compartment.
3. Reinstall the battery door and snap it closed.
4. Turn on the transmitter and check the status indicator for a solid green light.

If the status LED flashes red, the transmitter batteries may be weak, discharged or possibly installed incorrectly. Replace with new or freshly charged batteries. The power indicator light does not indicate the charge level of the battery pack installed in the model. Refer to the Troubleshooting section on page 28 for more information on the transmitter Status LED codes.



*A Quick Reference Guide has been provided for you in the battery compartment of the transmitter. Always store the Quick Reference Guide in your transmitter.

SETTING UP THE ANTENNA

The receiver antenna has been set up and installed from the factory. The antenna is secured by a 3x4mm set screw. To remove the antenna tube, simply remove the set screw with the included 1.5mm wrench.

When reinstalling the antenna, slide the antenna wire into the bottom of the antenna tube until the white tip of the antenna exits the top of the tube. Carefully curve the white tip over the antenna tube and install the antenna tip to hold it in place. Next, insert the antenna tube into the mount. Make sure the antenna wire is in the antenna mount slot, then install the set screw next to the antenna tube. Use the supplied 1.5mm wrench to tighten the screw just until the antenna tube is securely in place. Do not over tighten. **Do not bend or kink the antenna wire!** See the side bar for more information.

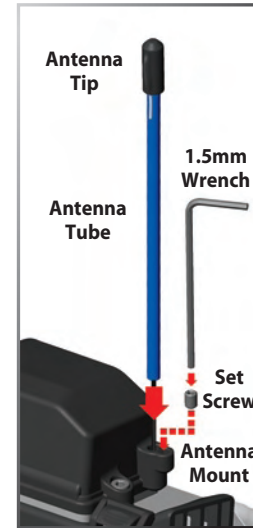

CHARGING THE BATTERY PACK

Your model includes a 'wall charger' that will charge the supplied battery in approximately six hours. Plug the charger into the wall. Connect the included battery pack to the charger output cord. After six hours, unplug the battery from the charger, and unplug the charger from the wall, when charging is complete. Never leave a battery unattended while charging.

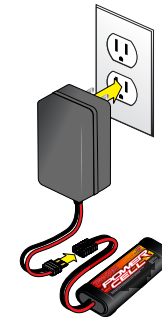

INSTALLING THE BATTERY PACK

Your model includes a 7.2-volt battery pack. To properly balance the model, it should be installed in the battery compartment on the left side of the model. Follow these steps to install the battery:

Battery Installation

1. Open the battery compartment door by pressing on the release tabs.



To prevent loss of radio range do not kink or cut the black wire, do not bend or cut the metal tip, and do not cut the white wire at the end of the metal tip.

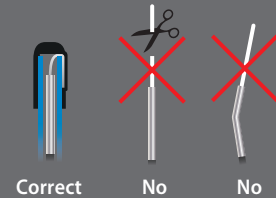

Use the Right Batteries

Your transmitter uses AA batteries. Use new alkaline batteries, or rechargeable batteries such as NiMH (Nickel Metal Hydride) batteries in your transmitter. Make sure rechargeable batteries are fully charged according to the manufacturer's instructions.

If you use rechargeable batteries in your transmitter, be aware that when they begin to lose their charge, they lose power more quickly than regular alkaline batteries.

Caution: Discontinue running your model at the first sign of weak batteries (flashing red light) to avoid losing control.





If the power indicator doesn't light green on the transmitter, check the polarity of the batteries. Check rechargeable batteries for a full charge. If you see any other flashing signal from the LED, refer to the chart on page 28 to identify the code.



The following Traxxas High Current Connector packages are available from your hobby dealer. When using adapters, be careful not to exceed the current rating of the Molex connector.

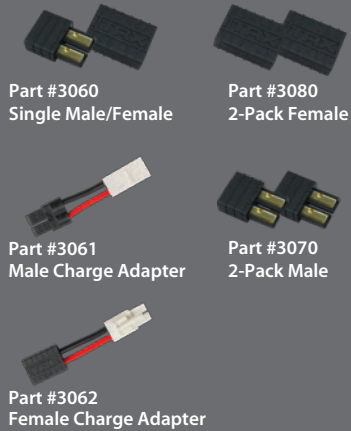

2. Install the battery pack with the battery wires facing the rear of the model.
3. Route the battery wire through the slot near the vent.
4. Close the battery door, making sure not to pinch the battery wires. Be sure both release tabs are fully engaged with the door. Do not connect the battery pack to the ESC at this time. **Note:** always unplug the battery and remove from the model after use.

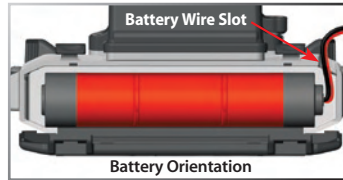

The Traxxas High Current Connector

Your model is equipped with the patented Traxxas High-Current Connector. Standard connectors restrict current flow and are not capable of delivering the power needed to maximize the output of the Velineon Brushless Power system.



The Traxxas connector's gold-plated terminals with large contact surfaces ensure positive current flow with the least amount of resistance. Secure, long-lasting, and easy to grip, the Traxxas connector is engineered to extract all the power your battery has to give.

Using LiPo Packs in Your Model

The VXL-3m is compatible with 2S and 3S LiPo packs, and is equipped with Low-Voltage Detection circuitry to prevent over-discharging. Make certain LiPo mode is selected (*see page 17 for details*) when using LiPo packs in your model.

Using an Additional Battery for Increased Run Time

Your model only requires one battery pack, but the chassis can accept two batteries. Your model can be run with two battery packs to extend run time. The batteries must be connected in parallel, which will combine the capacity of the two batteries (for example, two 7.2-volt 1000mAh packs connected in parallel will deliver a total capacity of 2000mAh, but total voltage will remain 7.2 volts). This is easily done with a parallel Y-harness (Part #3064, sold separately). Be sure to only use the Y-harness with identical battery packs; do not mix batteries of different chemistries or capacities.



When operating your model with two batteries, be careful to monitor the temperature of the speed control and motor to prevent overheating. Stop running your model and allow it to cool if the speed control's thermal overload protection activates or if the motor temperature exceeds 200° F.



For best on-road handling with two battery packs, consider installing stiffer springs on your model.

Using an Additional Battery For Increased Speed

An additional battery may also be used to increase the top speed of your model to 50+mph by connecting the batteries in series using a Traxxas series connector (Part #3063, sold separately). *This also requires a gearing change as described on page 24.*

50+mph Battery and Gearing Installation Instructions

1. Install the included high-speed pinion gear as described in *Pinion Gear Installation Instructions* on page 24. Install the supplied battery as described on page 11.
2. Install an identical Power Cell Series 1 battery (#2925 sold separately) in the opposite battery compartment.
3. Plug both batteries into the Y-harness (sold separately). The harness connects the two packs in series. The two 7.2-volt 6-cell battery packs will operate as one 14.4-volt 12-cell battery pack.
4. Plug the Y-harness into the speed control.



Precautions

- The High Speed dual-battery and gearing configuration is for high-speed running only. Avoid repetitive hard acceleration to prevent overstressing the motor, speed control and batteries.
- Make certain both batteries are fully charged before installing them in your model. Installing a fully charged pack and a partially discharged pack may lead to overdischarging and damage to the partially discharged battery.
- Do not mix batteries of different brands, chemistries or capacities. Only genuine Traxxas batteries are approved for dual-battery use in this model.
- Stop running your model and allow it to cool if the speed control's thermal overload protection activates or if the motor temperature exceeds 200° F.

TQ 2.4GHZ RADIO SYSTEM CONTROLS

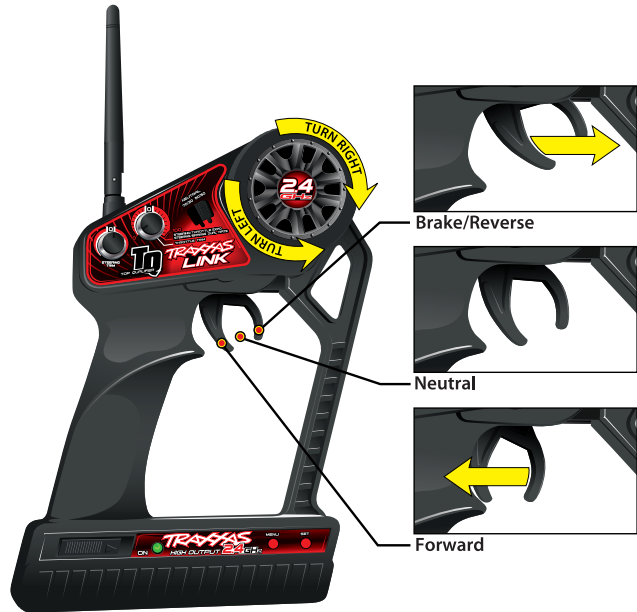

red indicating a failure to link. If you miss it, simply turn off the transmitter and start over.

- ⊕ Always turn on the transmitter before plugging in the battery.
- ⊕ Always use new or freshly charged batteries for the radio system. Weak batteries will limit the radio signal between the receiver and the transmitter. Loss of the radio signal can cause you to lose control of your model.

TQ 2.4GHZ RADIO SYSTEM BASIC ADJUSTMENTS

Throttle Neutral Adjustment

The throttle neutral adjustment is located on the transmitter face and controls the forward/reverse travel of the throttle trigger. Change the adjustment by pressing the button and sliding it to the desired position. There are two settings available:



- 50/50: Allows equal travel for both forward and reverse.
- 70/30: Allows more forward travel (70%) and less reverse travel (30%).

Note: We strongly recommend to leave this control in its factory location until you become familiar with all the adjustments and capabilities of your model. To change the throttle neutral adjust position, turn the transmitter off before adjusting the neutral position. You will need to reprogram your electronic speed control to recognize the 70/30 setting. Turn to ESC Setup Programming on page 16 for instructions.

Steering Trim

The electronic steering trim located on the face of the transmitter adjusts the neutral (center) point of the steering channel.



Multi-Function Knob

The Multi-Function knob can be programmed to control a variety of functions. From the factory, the Multi-Function knob controls steering sensitivity, also known as exponential or "expo." When the knob is turned counterclockwise all the way to the left (default position), expo is off and steering sensitivity will be linear (the most commonly used setting). Turning the knob clockwise will "add expo" and decrease the steering sensitivity in the initial range of steering wheel travel left or right from center. For more detail on steering exponential, refer to page 15.



TQ RADIO SYSTEM RULES

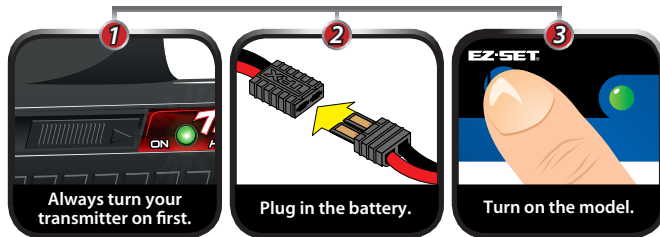

- ⊕ Always turn your TQ 2.4GHz transmitter on first and off last. This procedure will help to prevent your model from receiving stray signals from another transmitter, or other source, and running out of control. Your model has electronic fail-safes to prevent this type of malfunction, but the first, best defense against a runaway model is to always turn the transmitter on first, and off last.
- ⊕ In order for the transmitter and receiver to bind to one another, the receiver in the model must be turned on within 20 seconds of turning on the transmitter. The transmitter LED will flash fast

! Remember, always turn the TQ transmitter on first and off last to avoid damage to your model.

i **Automatic Fail-Safe**
The TQ 2.4GHz transmitter and receiver are equipped with an automatic fail-safe system that does not require user programming. In the event of signal loss or interference, the throttle will return to neutral and the steering will hold its last commanded position. If Fail-Safe activates while you are operating your model, determine the reason for signal loss and resolve the problem before operating your model again.

! When rechargeable batteries begin to lose their charge, they will fade much faster than alkaline dry cells. Stop immediately at the first sign of weak batteries. Never turn the transmitter off when the battery pack is plugged in. The model could run out of control.



Using Reverse: While driving, push the throttle trigger forward to apply brakes. Once stopped, return the throttle trigger to neutral. Push the throttle trigger forward again to engage proportional reverse.

USING THE TQ 2.4GHZ RADIO SYSTEM

The TQ 2.4GHz Radio System has been pre-adjusted at the factory. The adjustment should be checked before running the model, in case of movement during shipping. Here's how:

1. Turn the transmitter switch on. The status LED on the transmitter should be solid green (not flashing).
2. **Elevate the model on a block or a stand so that all the tires are off the ground.** Make sure your hands are clear of the moving parts of the model.
3. Plug the battery pack in the model into the speed control.
4. The on/off switch is integrated into the speed control. With the transmitter on, press and release the EZ-Set button (.25 seconds). The LED will shine RED (see note, below). This turns the model on. To turn the VXL-3m off, press and hold the EZ-Set button until the LED turns off (.5 seconds). **Note:** If the LED shines green, Low-Voltage Detection is activated. This may cause poor performance from the included NiMH battery pack. The default factory setting is for Low-Voltage Detection to be disabled (LED shines red). Make sure to turn the Low-Voltage Detection on when using LiPo batteries. **Never use LiPo batteries while Low-Voltage Detection is turned off.** See page 17 for more information.
5. Turn the steering wheel on the transmitter back and forth and check for rapid operation of the steering servo. Also, check that the steering mechanism is not loose or binding. If the steering operates slowly, check for weak batteries.

6. When looking down at model, the front wheels should be pointing straight ahead. If the wheels are turned slightly to the left or right, slowly adjust the steering trim control on the transmitter until they are pointing straight ahead.



7. Gently operate the throttle trigger to ensure that you have forward and reverse operation, and that the motor stops when the throttle trigger is at neutral. **Warning: Do not apply full throttle in forward or reverse while the model is elevated.**
8. Once adjustments are made, turn off the receiver on your model, followed by the hand-held transmitter.

Range-Testing the Radio System

Before each running session with your model, you should range-test your radio system to ensure that it operates properly.

1. Turn on the radio system and check its operation as described in the previous section.
2. Have a friend hold the model. Make sure hands and clothing are clear of the wheels and other moving parts on the model.
3. Make sure your transmitter antenna is straight up, and then walk away from the model with the transmitter until you reach the farthest distance you plan to operate the model.
4. Operate the controls on the transmitter once again to be sure that the model responds correctly.
5. Do not attempt to operate the model if there is any problem with the radio system or any external interference with your radio signal at your location.

• Higher Speeds Require Greater Distance

The faster you drive your model, the more quickly it will near the limit of radio range. At 60mph, a model can cover 88 feet every second! It's a thrill, but use caution to keep your model in range. If you want to see your model achieve its maximum speed, it is best to position yourself in the middle of the model's running area, not the far end, so you drive the model towards and past your position. In addition to maximizing the radio's range, this technique will keep your model closer to you, making it easier to see and control.

No matter how fast or far you drive your model, always leave adequate space between you, the model, and others. Never drive directly toward yourself or others.

TQ 2.4GHz Binding Instructions

For proper operation, the transmitter and receiver must be electronically 'bound.' **This has been done for you at the factory.** Should you ever need to re-bind the system or bind to an additional transmitter or receiver, follow these instructions. Note: the receiver must be connected to a 4.8-6.0v (nominal) power source for binding and the transmitter and receiver must be within 5 feet of each other.

1. Press and hold the transmitter's SET button as you switch transmitter on. The transmitter's LED will flash red slowly. Release the SET button
2. Press and hold the receiver's LINK button as you switch on the speed control by pressing the EZ-Set button. Release the LINK button.
3. When the transmitter and receiver's LEDs turn solid green, the system is bound and ready for use. Confirm that the steering and throttle operate properly before driving your model.

Steering Sensitivity (Exponential)

The Multi-Function knob on the TQ 2.4GHz transmitter has been programmed to control Steering Sensitivity (also known as exponential). The standard setting for Steering Sensitivity is "50% negative exponential" with the dial in the middle of its travel range (pointer straight up). Turning the knob clockwise will further decrease steering sensitivity by making the servo less responsive near neutral, with increasing sensitivity as the servo nears the limits of its travel range. The farther you turn the knob, the more pronounced the change in steering servo movement will be. The term "exponential" comes from this effect; the servo's travel changes exponentially relative to the input from the steering wheel. The exponential effect is indicated as a percentage—the greater the percentage, the greater the effect. The illustrations to the right show how this works.

Normal Steering Sensitivity (0% exponential)

In this illustration, the steering servo's travel (and with it, the steering motion of the model's front wheels) corresponds precisely with the steering wheel. The ranges are exaggerated for illustrative purposes.

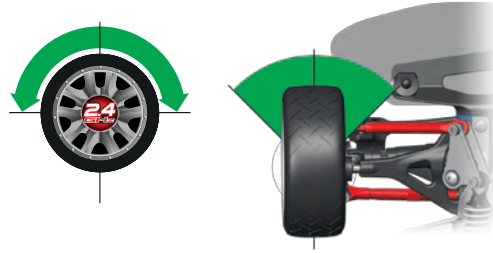

Decreased Steering Sensitivity (Negative Exponential)

By turning the Multi-Function knob clockwise, the steering sensitivity of the model will be decreased. The transmitter included with the Traxxas Rally has been set at the factory for decreased steering sensitivity. Note that a relatively large amount of steering wheel travel results in a smaller amount of servo travel. The farther you turn the knob, the more pronounced the effect becomes. Decreased steering sensitivity may be helpful when driving on low-traction surfaces, when driving at high speed, or on tracks that favor sweeping turns where gentle steering inputs are required. The ranges are exaggerated for illustrative purposes.

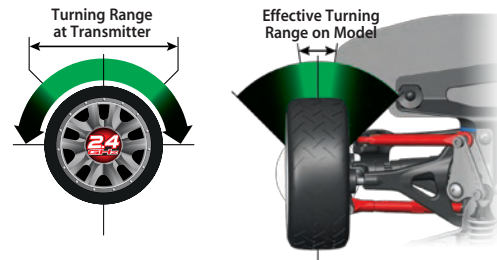

Experiment! Try varying degrees of exponential. It's easy to go back to "zero" if you don't like the effect. There's no wrong way to adjust exponential. Any setting that makes you more comfortable with your car's handling is the "right setting."



Steering exponential can help make the model easier to drive. Turning the transmitter's multi-function knob clockwise (when set for Steering Sensitivity) will decrease sensitivity, making the model less responsive when initiating a turn. Reducing steering sensitivity may also help you maintain a controlled slip angle when countersteering through a drift-turn. Experiment with the setting to find what works best for you.



VXL-3m LED codes

- **Solid Green:** VXL-3m power on light. Low-Voltage Detection is ON (LiPo setting).
- **Solid Red:** VXL-3m power on light. Low-Voltage Detection is OFF (NiCad/NiMH setting).
- ✶ **Fast Blinking Red:** Thermal Shutdown Protection Stage 1. If the motor has lower than normal power and the VXL-3m is hot, the VXL-3m has entered Stage 1 Thermal Shutdown Protection to guard against overheating caused by excessive current flow. If the motor has no power and the VXL-3m is very hot, the VXL-3m has entered Stage 2 Thermal Shutdown Protection and has automatically shut down. Let the VXL-3m cool. Make sure your model is properly geared for the conditions (see page 24).
- ✶ **Slow Blinking Red (with Low-Voltage Detection on):** The VXL-3m has entered Low-Voltage Protection. When the battery voltage begins to reach the minimum recommended discharge voltage threshold for LiPo battery packs, the VXL-3m will limit the power output to 50% throttle. When the battery voltage attempts to fall below the minimum threshold, the VXL-3m will shut down all motor output. The LED on the speed control will slowly blink red, indicating a low-voltage shutdown. The VXL-3m will stay in this mode until a fully charged battery is connected.
- ✶ **Alternating: Blinks Red then Green:** If the motor has no power, the VXL-3m has entered Over Voltage Protection. If a battery with too high voltage is used, the VXL-3m will go into a failsafe mode. **Warning:** If input voltage exceeds approximately 20 volts, the ESC may be damaged. Maximum peak input voltage limits are 12.6V in LiPo Mode (see page 17) and 18V in NiMH Mode.
- ✶ **Blinking Green:** The VXL-3m is indicating the transmitter Throttle Trim (see page 27) is incorrectly set. Adjust the Throttle Trim to the middle "0" setting.

The electronic speed control is factory set and should not require any adjustments. These instructions are provided for your reference.

Transmitter Adjustments for the electronic speed control

Before attempting to program your ESC, it is important to make sure your TQ transmitter is properly adjusted (set back to the factory defaults). Otherwise, you may not get the best performance from your speed control.

The transmitter should be adjusted as follows:

If the transmitter setting have been adjusted, reset them to the factory defaults.

1. Turn transmitter off.
2. Hold both MENU and SET.
3. Turn transmitter on.
4. Release MENU and SET. The transmitter LED will blink red.
5. Press SET to clear settings. The LED will turn solid green and the transmitter is restored to default.

Setup Programming (Calibrating your ESC and transmitter)

Read through all of the following programming steps before you begin. If you get lost during programming or receive unexpected results, simply unplug the battery, wait a few seconds, plug the battery back in, and start over.

1. Disconnect each of the motor wires between the ESC and the motor. This is a precaution to prevent runaway when the speed control is turned on before it is programmed.
2. Connect a fully charged battery pack to the ESC.
3. Turn on the transmitter (with the throttle at neutral).
4. Press and hold the EZ-Set button (A). The LED will first turn green and then red. Release the EZ-Set button.
5. When the LED blinks RED ONCE. Pull the throttle trigger to the full throttle position and hold it there (B).
6. When the LED blinks RED TWICE. Push the throttle trigger to the full reverse and hold it there (C).



7. When the LED starts flashing GREEN, programming is complete. After the throttle is returned to neutral, the LED will then shine solid green or red (depending on the Low-Voltage Detection setting, see note below) indicating the VXL-3m is on and at neutral (D).



ESC Operation

Note: In steps 1-7 below, Low-Voltage Detection is turned off (factory default) and the LED shines RED. If Low-Voltage Detection is on, the LED will shine GREEN instead of RED in steps 1-7 below.

To operate the speed control and test the programming, place the vehicle on a stable block or stand so all of the driven wheels are off the ground. Reconnect the motor wires. Always make sure that objects and fingers are clear of the wheels.

1. With the transmitter on, press the EZ-Set button for ½ second, until the LED shines GREEN, then immediately release the button. This turns on the ESC. If you press and release too quickly, you may hear the steering servos jump but the LED may not stay on.
2. Apply forward throttle. The LED will turn off until full throttle power is reached. At full throttle, the led will shine RED.
3. Move the trigger forward to apply the brakes. Note that braking control is fully proportional. The LED will turn off until full braking power is reached. At full brakes, the LED will shine RED.
4. Return the throttle trigger to neutral. The LED will shine RED.
5. Move the throttle trigger forward again to engage reverse (Profile #1). The LED will turn off. Once full reverse power is reached, the LED will shine RED.
6. To stop, return the throttle trigger to neutral.
7. To turn the ESC off, press the EZ-Set button until the RED LED turns off.

VXL-3m Thermal Shutdown Protection

The VXL-3m is also equipped with thermal shutdown protection. If the operating temperature exceeds safe limits, the ESC will reduce power to 50% and the LED will flash red. Additional heating will cause the speed control to shut down completely until it reaches a safe operating temperature. Traxxas encourages you to stop driving as soon as the thermal overload protection is activated.

ESC Profile Selection

The speed control is factory set to Profile #1. To change the profile, follow the steps described. The speed control should be connected to the receiver and battery, and the transmitter should be adjusted as described previously. The profiles are selected by entering the programming mode.

ESC Profile Description

Profile #1 (Sport Mode): 100% Forward, 100% Brakes, 100% Reverse

Profile #2 (Race Mode): 100% Forward, 100% Brakes, No Reverse

Profile #3 (Training Mode): 50% Forward, 100% Brakes, 50% Reverse

Selecting Sport Mode (Profile #1)

1. Connect a fully charged battery pack to the ESC and turn on your transmitter.
2. With the ESC off, press and hold the EZ-Set button until the light turns solid green, then solid red and then begins blinking red (indicating the Profile numbers).
3. When the light blinks red once, release the EZ-Set button.
4. The light will then turn red and the model is ready to drive.

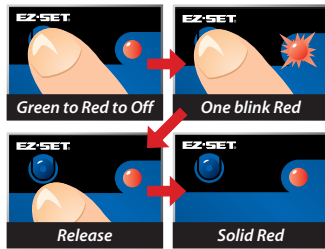

Selecting Race Mode (Profile #2)

1. Connect a fully charged battery pack to the ESC and turn on your transmitter.
2. With the ESC off, press and hold the EZ-Set button until the light turns solid green, then solid red and then begins blinking red (indicating the Profile numbers).
3. When the light blinks red twice, release the EZ-Set button.
4. The light will then turn red and the model is ready to drive.

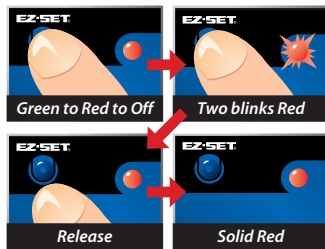

Selecting Training Mode* (Profile #3)

1. Connect a fully charged battery pack to the ESC and turn on your transmitter.
2. With the ESC off, press and hold the EZ-Set button until the light turns solid green, then solid red and then begins blinking red (indicating the Profile numbers).
3. When the light blinks red three times, release the EZ-Set button.
4. The light will then turn red and the model is ready to drive.

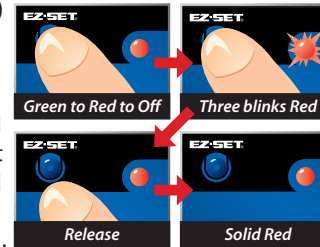

Note: If you missed the mode you wanted, keep the EZ-Set button pressed down and the blink cycle will repeat until a Mode is selected.

LiPo Battery Mode with Low-Voltage Detection

The VXL-3m ESC is equipped with built-in Low-Voltage Detection for safe use with Lithium Polymer (LiPo) batteries. The Low-Voltage Detection circuitry constantly monitors the battery voltage. When the battery voltage begins to reach the minimum recommended discharge voltage threshold for LiPo battery packs, the VXL-3m will limit the power output to 50% throttle. When the battery voltage attempts to fall below the minimum threshold, the VXL-3m will shut down all motor output. The LED on the speed control will slowly blink red, indicating a low-voltage shutdown. The VXL-3m will stay in this mode until a fully charged battery is connected. The electronic speed control is factory set with Low-Voltage Detection disabled. **Be certain to activate Low-Voltage Detection if you install LiPo batteries in your model.**

To activate Low-Voltage Detection (LiPo setting):

1. Make sure the LED on the ESC is on and red.
2. Press and hold the EZ-Set button for ten seconds. The LED will turn off and then light green. Also, a "rising" musical tone will be emitted from the motor.
3. Low-Voltage Detection is now ACTIVATED.

To disable Low-Voltage Detection (NiMH setting):

1. Make sure the LED on the ESC is on and green.
2. Press and hold the EZ-Set button for ten seconds. The LED will turn off and then light red. Also, a "falling" musical tone will be emitted from the motor.
3. Low-Voltage Detection is now DISABLED.

Never use LiPo batteries while Low-Voltage Detection is disabled.



Patent Pending Training Mode (Profile #3) reduces forward and reverse throttle by 50%. Training Mode is provided to reduce the power output allowing beginning drivers to better control the model. As driving skills improve, simply change to Sport or Race Mode for full-power operation.



Tip For Fast Mode Changes
The ESC is set to Profile 1 (Sport Mode) as the default. To quickly change to Profile 3 (Training Mode), with the transmitter on and the ESC turned off, press and hold the SET button until the light blinks red three times and then release. For full power, turn off the ESC then quickly change back to Profile 1 (Sport Mode) by pressing and holding the SET button until the light blinks red one time and then releasing.

DRIVING YOUR MODEL

Now it's time to have some fun! This section contains instructions on driving and making adjustments to your model. Before you go on, here are some important precautions to keep in mind.

- ⚠ Allow the model to cool for a few minutes between runs. This is particularly important when using high capacity battery packs that allow extended periods of running. Monitoring temperatures will extend the lives of the battery and motor.
- ⚠ Do not continue to operate the model with low batteries or you could lose control of it. Indications of low battery power include slow operation and sluggish servos (slow to return to center). Stop immediately at the first sign of weak batteries. When the batteries in the transmitter become weak, the red power light will begin to flash. Stop immediately and install new batteries.
- ⚠ Do not drive the model at night, on public streets, or in large crowds of people.
- ⚠ If the model becomes stuck against an object, do not continue to run the motor. Remove the obstruction before continuing. Do not push or pull objects with the model.
- ⚠ Because the model is controlled by radio, it is subject to radio interference from many sources beyond your control. Since radio interference can cause momentary losses of control, allow a safety margin of space in all directions around the model in order to prevent collisions.
- ⚠ Use good, common sense whenever you are driving your model. Intentionally driving in an abusive and rough manner will only result in poor performance and broken parts. Take care of your model so that you can enjoy it for a long time to come.
- ⚠ High performance vehicles produce small vibrations which may loosen hardware over time. Frequently check wheel nuts and other screws on your vehicle to ensure that all hardware remains properly tightened.

About Run Time

A large factor affecting run time is the type and condition of your batteries. The milliamp hour (mAh) rating of the batteries determines how large their "fuel tank" is. A 2000 mAh battery pack will theoretically run twice as long as a 1000 mAh pack. Because of the wide variation in the types of batteries that are available and the methods with which they can be charged, it's impossible to give exact run times for the model.

Another major factor which affects run time is how the model is driven. Run times may decrease when the model is driven repetitively from a stop to top-speed and with repetitive hard acceleration.

Tips for Increasing Run Time

- ⚠ Use batteries with the highest mAh rating you can purchase.
- ⚠ Use the included charger or a high-quality peak-detecting charger.
- ⚠ Read and follow all maintenance and care instructions provided by the manufacturer of your batteries and charger.
- ⚠ Keep the ESC cool. Get plenty of airflow across the ESC heat sinks.
- ⚠ Lower your gear ratio. Installing smaller pinion gears will lower your gear ratio and cause less power draw from the motor and batteries, and reduce overall operating temperatures.
- ⚠ Maintain your model. Do not allow dirt or damaged parts to cause binding in the drivetrain. Keep the motor clean.

mAh Ratings and Power Output

The mAh rating of the battery can effect your top speed performance. The higher capacity battery packs experience less voltage drop under heavy load than low mAh rated packs. The higher voltage potential allows increased speed until the battery begins to become discharged

RUNNING IN WET CONDITIONS

Your model is designed with water-resistant features to protect the electronics in the model (receiver, servos, electronic speed control). This gives you the freedom to have fun driving your model through puddles, wet grass, snow, and other wet conditions. Though highly water resistant, the model should not be treated as though it is submersible or totally, 100% waterproof. Water resistance applies only to the installed electronic components. Running in wet conditions requires additional care and maintenance for the mechanical and electrical components to prevent corrosion of metal parts and maintain their proper function.

Precautions

- ⚠ **Without proper care, some parts of your model can be seriously damaged due to contact with water. Know that additional maintenance procedures will be required after running in wet conditions in order to maintain the performance of your model. Do not run your model in wet conditions if you are not willing to accept the additional care and maintenance responsibilities.**



- ⚠ Not all batteries can be used in wet environments. Consult your battery manufacturer to see if their batteries can be used in wet conditions.
- ⚠ The Traxxas TQ transmitter is not water resistant. Do not subject it to wet conditions such as rain.
- ⚠ Do NOT operate your model during a rain storm or other inclement weather where lightning may be present.
- ⚠ Do NOT allow your model to come in contact with salt water (ocean water), brackish water (between fresh water and ocean water), or other contaminated water. Salt water is highly conductive and highly corrosive. Use caution if you plan to run your model on or near a beach.
- ⚠ Even casual water contact can reduce the life of your motor. Special care must be taken to modify your gearing and/or your driving style in wet conditions to extend the life of the motor (details below).

Before Running Your Vehicle in Wet Conditions

1. Consult the section "After Running Your Vehicle in Wet Conditions" before proceeding. Make sure you understand the additional maintenance required with wet running.
2. The wheels have small holes molded in to allow air to enter and exit the tire during normal running. Water will enter these holes and get trapped inside the tires if holes are not cut in the tires. Cut two small holes (4mm or 3/16" diameter) in each tire. Each hole should be near the tire centerline, 180 degrees apart.
3. Confirm that the receiver box O-ring and cover are installed correctly and secure. Make sure the screws are tight and the blue O-ring is not visible protruding from the edge of the cover.
4. Confirm that your batteries can be used in wet conditions.
5. Use lower gearing (smaller pinion gears) when running in mud, deep puddles, snow, or other similar situations that will restrict the tires and put much higher loads on the motor.

Motor Precautions

- ⚠ Motor life can be greatly reduced in mud and water. If the motor get excessively wet or submerged, use very light throttle (run the motor slowly) until the excess water can run out. Applying full throttle to a motor full of water can cause rapid motor failure. Your driving habits will determine motor life with a wet motor. Do not submerge the motor under water.

- ⚠ Do not gear the motor by temperature when running in wet conditions. The motor will be cooled by water contact and will not give an accurate indication of appropriate gearing.

After Running Your Vehicle in Wet Conditions

1. Drain the tires by spinning the tires at full throttle to "sling" the water out. An easy way to do this is to remove the body and set the model upside down on a flat surface. Apply full throttle so the tires spin and throw the excess water out of the holes you cut into the tires.
2. Remove the battery.
3. Rinse excess dirt and mud off the model with low-pressure water, such as from a garden hose. Do NOT use a pressure washer or other high-pressure water. Avoid directing water into the bearings, transmission, differentials, etc.
4. Blow off the model with compressed air (optional, but recommended). Wear safety glasses when using compressed air.
5. Remove the wheels from the model.
6. Spray all the bearings, drivetrain, and fasteners with WD-40® or similar water displacing light oil.
7. Let the model stand or you may blow off with compressed air. Placing the model in a warm sunny spot will aid drying. Trapped water and oil will continue to drip from the model for a few hours. Place it on a towel or piece of cardboard to protect the surface underneath.
8. As a precautionary step, remove the sealed receiver box cover. While unlikely, humidity or tiny amounts of moisture or condensation may enter the receiver box during wet running. This can cause long-term problems with the sensitive electronics in the receiver. Removing the receiver box cover during storage allows the air inside to dry. This step can improve the long-term reliability of the receiver. It is not necessary to remove the receiver or unplug any of the wires.
9. **Additional Maintenance:** Increase your frequency of disassembly, inspection and lubrication of the following items: This is necessary after extended wet use or if the vehicle will not be used for an extended period of time (such as a week or longer). This additional maintenance is needed to prevent any trapped moisture from corroding internal steel components.
 - **Stub axle housing bearings:** Remove, clean, and re-oil the bearings.
 - **Front and rear differential:** Remove, disassemble, clean, and re-grease the differentials. Refer to your exploded view diagrams for help with disassembly and reassembly.

- **Transmission:** Remove, disassemble, and clean the transmission components. No grease is required for the nylon gears. Refer to your exploded view diagrams for help with disassembly and reassembly.
- **Motor:** Remove the motor, clean with aerosol motor cleaner, and re-oil the bearings (Velineon 380 motor) with lightweight motor oil. Be sure to wear eye protection when using spray aerosol cleaners.



Receiver Box: Maintaining a Watertight Seal

The unique design of the receiver box allows the removal and installation of the receiver without losing the ability to maintain a watertight seal in the box. The patent-pending wire clamp feature gives you the ability to also install aftermarket radio systems and maintain the watertight features of the receiver box.

Removing the Receiver

1. Remove the 2.5x8mm screws that secure the wire clamp.
2. Remove the 2.5x8mm screws that secure the receiver box lid to the chassis. Lift the lid up and toward you to disengage the lid's tab from its slot in the chassis.
3. You can now access the receiver. Unplug the servo cables from the receiver and remove the receiver.

Receiver Installation

1. Route the antenna wire out of the receiver box cover (A). Place the cover on the chassis.
2. Route the servo and speed control leads into the receiver box cover. Use the molded-in wire guides to align the servo and speed control leads and antenna wire (B).
3. Apply a small bead of silicone grease (Traxxas part #1647) to the wire clamp (C).
4. Install the wire clamp and tighten the two 2.5x8mm screws securely (D).

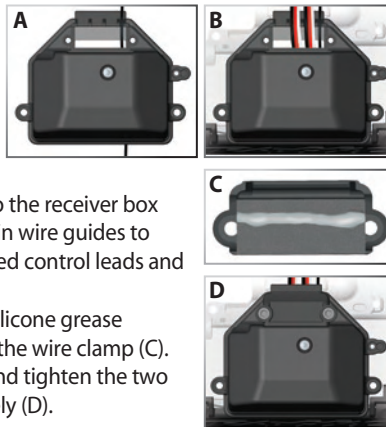

5. Lift the receiver box cover and plug the servo and speed control leads into the receiver (E). Refer to page 10 for the wiring diagram.
6. Bundle the wires so they fit beneath the receiver box cover. You may secure the receiver to the chassis with mounting tape if you wish, but this is not required. The excess wire beneath the cover will prevent the receiver from rattling.
7. Make sure the clear plastic light pipe in the receiver box is aligned above the LED on the receiver.
8. Make sure the blue O-ring is properly seated into the groove around the receiver cover base so the cover will not pinch or damage the O-ring. Snap the receiver box cover into place (F).
9. Inspect the cover to make sure the O-ring is not visible. If it is, remove the cover and reposition the O-ring. With the O-ring and cover properly seated, install the 2.5x8mm screws and tighten them securely (G).

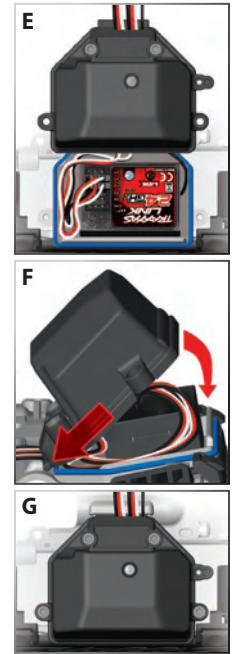

TUNING ADJUSTMENTS

Your model is factory-tuned for optimum performance on pavement and concrete surfaces. To tailor the performance and handling of your model to suit your driving style and available traction, your model has a number of adjustable features. Gearing, shock preload and damping, ride height, wheel toe and wheel camber can all be easily adjusted.

SUSPENSION TUNING

Ride Height Adjustment

Your model has threaded shock bodies that make it easy to adjust ride height. Threading the shocks' preload collars away from the caps will raise the vehicle's ride height (the distance from the chassis to the ground), and reduce the suspension's down travel, also known as 'sag' or 'droop'. This can be helpful on rough surfaces where extra ground clearance is needed. However, the vehicle's center of gravity (CG) will be raised, making it less stable.

Threading the shocks' preload collars toward the caps will lower the vehicle's ride height and increase the suspension's droop. This will lower the vehicle's CG and improve handling, but it will also reduce ground clearance.

From the factory, your model is set up as shown in the illustration above. At rest, the suspension sags to about 1/2 of its total travel. This allows the suspension to extend so the wheel can drop into depressions over rough surfaces. This leaves 1/2 of the total suspension travel for compression when absorbing bumps. These settings are ideal for most flat surfaces, and only small changes in ride height should be required to fine-tune the vehicle's handling for your particular surface.

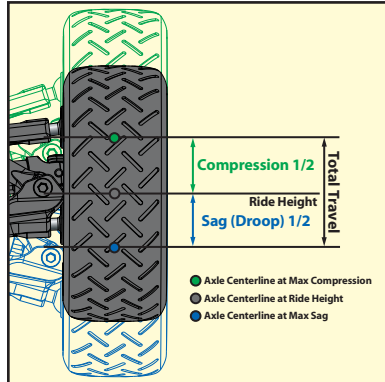

Shock Oil

The 4 oil-filled shocks (dampers) effectively control the suspension movement by preventing the wheels and tires from continuing to "bounce" after rebounding from a bump. Changing the oil in the shocks can vary the suspension damping effect. Changing the oil to a higher viscosity oil will increase damping. Lowering the viscosity of the oil will cause the suspension damping to be reduced. Damping should be increased (with higher viscosity oil) if the model is bottoming easily over bumps. Damping should be decreased (with thinner viscosity oil) if the model is hopping over small bumps and feels unstable. The viscosity of shock oil is affected by extremes in operating temperature; an oil of certain viscosity will become less viscous at higher temperatures and more viscous at lower temperatures. Operating in regions with cold temperatures may require lower viscosity oil. Your model's shocks are filled with SAE 60W oil. Only use 100% silicone oil in the shock.

Replacing Shock Oil

The shocks have to be removed from the vehicle and disassembled to change the oil.

1. Remove the lower spring retainer and shock spring.
2. Remove the upper shock cap. If you cannot unscrew the cap with your fingers, pass the 2mm 'L' wrench through the cap's eyelet so you can apply more leverage. Turn the cap counterclockwise to loosen it.
3. Empty the used shock oil from the shock body.
4. Fill the shock with new silicone shock oil up to the top of the shock body.
5. Slowly move the piston up and down (always keeping it submerged in oil) to release the air bubbles. Let the shock sit for a few minutes to allow any remaining air bubbles to surface.
6. Slowly thread the upper cap with the installed shock bladder onto the shock body. The excess oil will bleed out of the small hole in the shock cap.
7. Tighten the shock cap until snug.

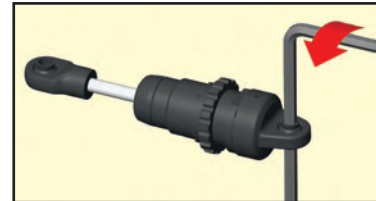

Important: The shocks are assembled at the factory with a center-to-center distance (between the rod end balls) of 43.75mm. Any time the shocks are removed and disassembled, this distance should be checked to ensure proper operation of the suspension.





A camber gauge (available at your local hobby shop) can be a useful tool for alignment setting.



To achieve a good starting point for the slipper clutch, tighten the slipper clutch adjusting nut clockwise until the slipper clutch adjusting spring fully collapses (do not over tighten), and then turn the slipper clutch nut counter-clockwise $\frac{3}{4}$ to 1 turn.

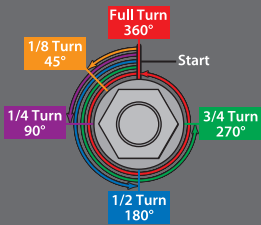

Static Camber Adjustment

The wheels can be set to have either positive or negative camber (see illustration below). The camber angle changes as the wheel moves up and down through its range of travel. Static camber is the camber angle at the wheel when the vehicle is set at its normal, stationary ride height.

The suspension pivot balls located in the axle carriers adjust the static camber. Camber is factory-set at negative 2-degrees. To adjust static camber, insert the supplied 2mm hex wrench into the pivot ball (compressing the suspension until the arms are parallel to the ground will allow for easier hex wrench engagement). Negative camber can be increased by unthreading the lower pivot ball. Zero camber or positive camber (not recommended) can be achieved by unthreading the upper pivot ball. Note that camber changes will also effect the toe angle of the wheel being adjusted.

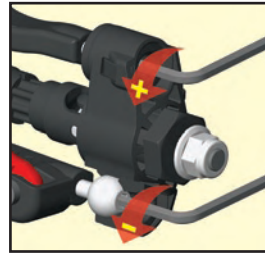

Static Camber Base Factory Settings

Front: 2-degree negative camber each side

Rear: 2-degree negative camber each side



Negative camber

Wheels lean in, toward chassis



Positive camber

Wheels lean out, away from chassis

Adjusting Toe-In

Toe-in refers to the angle of the front and rear wheels as viewed from above (see the diagram below). The handling of your model can be adjusted by altering the front and rear toe angles.

Front Toe Adjustment:

The toe-in of your model's front wheels can be adjusted by threading the front pivot balls in or out of the suspension arms. Threading the upper and lower pivot balls into the arms (by turning them clockwise) will increase toe-in. Threading the pivot balls out of the arms (by turning them counter-clockwise) will reduce toe-in. Front toe-in increases straight line stability and will help the car to self-correct to a straight path when transitioning from turns to straight-aways. Decreasing front toe-in or using toe-out will reduce straight-line stability, but will make the car's handling feel more aggressive when initiating a turn.



Toe-in

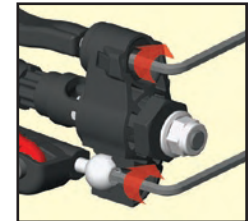

Rear Toe Adjustment: Rear toe-in is adjusted in the same way as front toe-in, by adjusting the depth of the pivot balls in the arms. Increasing rear toe-in will add stability to the model and make the car handle less aggressively (to use racing terminology, the car will have "less steering"). Reducing toe-in will "loosen" the rear of the car, making it more likely to spin-out (oversteer). Rear toe-out is not recommended, as it will cause erratic handling.

For gymkhana-style driving, 1-2 degrees of front and rear toe-in is recommended. The stock settings for your model are 1-degree front toe-in and 1.5 degrees rear toe-in.

For maximum adjustability, Traxxas offers threaded aluminum toe links (Part #7038X) for your model.

TRANSMISSION TUNING

Adjusting the Slipper Clutch

Your model is equipped with an adjustable Torque Control slipper clutch which is built into the large spur gear. The purpose of the slipper clutch is to prevent over-stressing of the drivetrain and transmission gears. It may also be used to regulate the amount of power sent to the rear wheels to prevent tire spin. When it slips, the slipper clutch makes a high-pitch, whining noise.

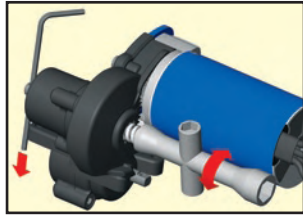

To adjust the slipper clutch, remove the receiver box cover. The slipper clutch is integrated into the main spur gear on the transmission. The slipper clutch is adjusted using the spring-loaded locknut on the slipper shaft. Use the supplied universal wrench. To tighten or loosen the slipper nut, insert the 1.5mm hex wrench into the hole in the end of the slipper shaft. This locks the shaft for adjustments. Turn the adjustment nut clockwise to tighten (less slippage) and counter-clockwise to loosen (more slippage).

Tuning the Sealed Gear Differentials

Your model is equipped with sealed, bevel gear differentials. The differentials allow the left and right wheels to spin at different speeds while turning. You can increase or decrease the torque transmitted between the left and right wheels by changing the viscosity of the silicone oil inside the differentials. The viscosity of the oil is indicated as a weight (W). Higher weights are more viscous, meaning the oil is "thicker." Lower weight numbers are less viscous, meaning the oil is "thinner." Filling the differential with higher viscosity (thicker) oil "tightens" the differential, transferring more power to the wheel with the most traction. Filling the differentials with lower viscosity (thinner) oil "loosens" the differential, transferring less power to the wheel with the most traction. Traxxas sells a variety of differential tuning oils specifically designed for use in your model.

Your model's gear differentials have been tuned specifically to provide balanced handling and authentic rally-style drift-cornering. The front differential has been filled from the factory with high-viscosity 50,000W silicone oil. The 50,000W oil allows the front wheels to pull the car through the turn when counter steering through a drift. Increasing the fluid viscosity increases the authority of the steering while drifting, but decreases the steering when not drifting ("grip driving"). Increasing the front differential viscosity too much will make the car difficult to drive ("twitchy"). Decreasing the front differential viscosity will decrease the ability of the car to drift, but will increase steering response when grip driving.

Front Differential oil viscosity tuning suggestions

- For drift cornering with a single Series 1 battery (6-cell NiMH), use the stock differential oil.
- For drift cornering with dual Series 1 batteries (12-cell NiMH), use thicker/higher viscosity differential oil (higher weight number).
- For grip driving with single or dual batteries, use thinner/lower viscosity differential oil (lower weight number).

Tuning the rear differential fluid will allow you to fine tune the amount of angle the car will exhibit during a drift. The rear differential is filled with 30,000W oil to keep the rear of the car from sliding out completely when drifting around a turn. Increasing the viscosity of the fluid will cause the car to over-rotate resulting in a spin. Decreasing the viscosity of the fluid will reduce the car's drift angle. For grip driving, lowering the viscosity will allow the car to turn more easily.

Rear Differential oil viscosity tuning suggestions

- For drift cornering with a single Series 1 battery (6-cell NiMH), use the stock differential oil.
- For drift cornering with dual Series 1 batteries (12-cell NiMH), use thicker/higher viscosity differential oil (higher weight number).
- For grip driving with single or dual batteries, use thinner/lower viscosity differential oil (lower weight number).

Gearing Compatibility Chart

This chart shows a full range of gear combinations. The gear combinations in gray are not suitable when using the included 6-cell battery, speed control and motor. These gear combinations have been included in this chart as they may be used with certain other aftermarket equipment combinations.

		Spur Gear		
		45	50	55
Pinion Gear	11	-	-	25.20
	12	-	-	23.10
	13	-	-	21.32
	14	-	-	19.80
	15	-	-	18.48
	16	-	15.75	17.33
	17	-	14.82	16.31
	18	-	14.00	15.40
	19	-	13.26	14.59
	20	-	12.60	13.86
	21	10.80	12.00	13.20
	22	10.31	11.45	12.60
	23	9.86	10.96	12.05
	24	9.45	10.50	11.55
	25	9.07	10.08	11.09
	26	8.72	9.69	10.66
	27	8.40	9.33	10.27
	28	8.10	9.00	9.90
	29	7.82	8.69	9.56
	30	7.56	8.40	9.24
	31	7.32	8.13	8.94

- Stock setup
- High Speed Gearing
- Acceptable range

MOTOR AND GEARING

Extensive testing has been done to determine the best gear ratio for your model. The stock gearing balances power, speed, and efficiency to optimize the performance of the model. However, you may wish to try different gear ratios in order to customize the performance of your model. The gearing chart on this page shows appropriate gearing for the model.

By installing a pinion with fewer teeth, or a spur gear with more teeth, the transmission's final drive ratio is increased. This means greater rpm is required to achieve a given speed. Using a numerically higher gear ratio will increase torque, but reduce top speed. Installing a pinion with more teeth, or a spur gear with fewer teeth, will decrease the final drive ratio, which will generally increase top speed but reduce torque. However, installing too large a pinion will "overgear" the car, which will reduce performance and may overheat the motor and speed control. Use the following formula to calculate the overall ratio for combinations not listed on the gear chart:

$$\frac{\text{\# Spur Gear Teeth}}{\text{\# Pinion Gear Teeth}} \times 5.04 = \text{Final Gear Ratio}$$

Motor Installation

To access the motor, remove the gear cover by removing the single screw on the top of the gear cover. The motor uses an aluminum mount for quick, easy motor access and gearing adjustment. To remove the motor, first open the right battery door and slide out the ESC. Next, remove the single large hex screw using the supplied 2.5mm wrench. Then rotate the motor and mount to the side of the model, and slide backward off the post.

The motor mount is carefully engineered to provide additional features and adjustability. Two sets of holes are

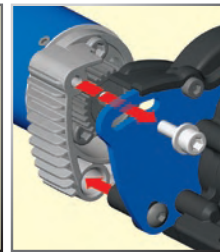
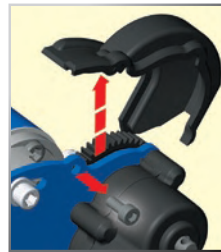

Motor Mount Positions



- Brushed Motors
- Brushless Motors

provided for use with brushed and brushless motors. The holes for brushed motors are spaced 16mm apart and accept 2.5mm screws. The holes for brushless motors are spaced 19mm apart and accept 3mm screws.

Pinion Gear Installation Instructions

1. Remove the motor as described previously in *Motor Installation*.
2. Use a 1.5mm wrench to loosen the pinion's set screw. Remove the pinion.
3. Place the replacement pinion gear onto the motor shaft. Align the set screw hole with the flat side of the shaft.
4. Thread a 1.5mm set screw into the pinion gear but do not tighten it yet.
5. Slide the pinion gear down the motor shaft so the wrench shaft fits into the notch in the motor mount, as shown. Tighten the set screw.

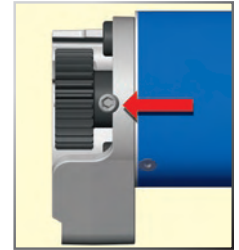

Adjusting Gear Mesh

Incorrect gear mesh is the most common cause of stripped spur gears. Gear mesh should be checked and adjusted anytime a gear is replaced. Access the gears by removing the single screw on the top gear cover.

To set the gear mesh, cut a narrow strip of notebook paper and run it into the gear mesh of the motor. The motor is mounted to an aluminum motor mount. Loosen the single motor mount screw with the provided 2.5mm wrench to slide the motor mount. Slide the motor and pinion gear into the spur gear. Retighten the motor mount screw and then remove the strip of paper. You should be able to run a fresh strip of paper through the gears without binding them.



High Speed Gearing

The included high-speed pinion gear can be installed to increase the top speed of your model to 50+mph. This also requires the use of an additional battery (sold separately) and a Traxxas series connector (Part #3063, sold separately). *See page 12 for more information.*

50+mph Battery and Gearing Installation Instructions

1. Install the included high-speed pinion gear as described in *Pinion Gear Installation Instructions* on page 24. Install the supplied battery as described on page 11.
2. Install an identical Power Cell Series 1 battery (#2925) sold separately) in the opposite battery compartment.
3. Plug both batteries into the Y-harness (sold separately). The harness connects the two packs in series. The two 7.2-volt 6-cell battery packs will operate as one 14.4-volt 12-cell battery pack.
4. Plug the Y-harness into the speed control.



Precautions

- The High Speed dual-battery and gearing configuration is for high-speed running only. Avoid repetitive hard acceleration to prevent overstressing the motor, speed control and batteries.
- Make certain both batteries are fully charged before installing them in your model. Installing a fully charged pack and a partially discharged pack may lead to overdischarging and damage to the partially discharged battery.
- Do not mix batteries of different brands, chemistries or capacities. Only genuine Traxxas batteries are approved for dual-battery use in this model.
- Stop running your model and allow it to cool if the speed control's thermal overload protection activates or if the motor temperature exceeds 200° F.

WHEELS AND TIRES

The Traxxas split-spoke wheels on your model are designed specifically for optimum performance with the model's officially licensed BFGoodrich® Rally tires. The tires are modeled after the full-size rally competition tire for authentic looks and performance. In developing the tire, Traxxas formulated a special tread compound that allows controlled rally- and gymkhana-style drift-cornering, but also provides sufficient traction for straight-line acceleration and high-speed driving. This allows the model to perform exciting drift maneuvers without the hard-to-control "driving on ice" feeling typical of solid plastic "drift tires" that do not provide enough grip for high-performance driving.

Your model is equipped with standard-size touring car wheels and tires that fit 12mm axle hexes. The wheels are 26mm wide and have a +4mm offset. The Traxxas split-spoke wheels are engineered specifically for your model, but many aftermarket touring car wheels and tires can also be fitted to alter the styling and handling characteristics of your model.



Always wear eye protection when using compressed air or spray cleaners and lubricants.

Your model requires timely maintenance in order to stay in top running condition. **The following procedures should be taken very seriously.**

Inspect the vehicle for obvious damage or wear. Look for:

1. Cracked, bent, or damaged parts
2. Check the wheels and steering for binding.
3. Check the operation of the shock absorbers.
4. Check the wiring for any frayed wires or loose connections.
5. Check the mounting of the receiver and servo(s) and speed control.
6. Check the tightness of the wheel nuts with a wrench.
7. Check the operation of the radio system, especially the condition of the batteries.
8. Check for any loose screws in the chassis structure or suspension.
9. Inspect the gears for wear, broken teeth, or debris lodged between the teeth.
10. Check the tightness of the slipper clutch.
11. Check the tightness of the front pivot balls.

Other periodic maintenance:

☞ Slipper clutch pad (friction material):

Under normal use, the friction material in the slipper clutch should wear very slowly. If the slipper clutch fails to provide consistent performance or slips even when the adjustment nut is fully tightened, disassemble the slipper clutch and replace the slipper pad. Inspect the spur gear and pressure plate for wear or damage and replace if necessary.

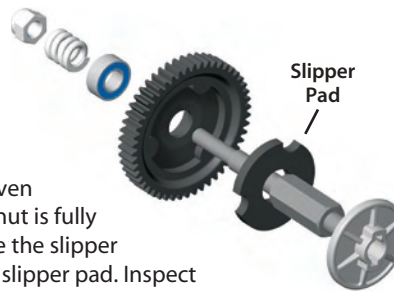

☞ Chassis: Keep the chassis clean of accumulated dirt and grime. Periodically inspect the chassis for damage.

☞ Shocks: Keep the oil level in the shocks full. Use only 100% pure silicone shock oil to prolong the life of the seals. If you are experiencing leakage around the top of the shock, inspect the

bladder in the top cap for signs of damage or distortion from overtightening. If the bottom of the shock is leaking, then it is time for a rebuild. The Traxxas rebuild kit for two shocks is part #7062.

☞ Suspension: Periodically inspect the model for signs of damage such as bent or dirty suspension pins, bent turnbuckles, loose screws, and any signs of stress or bending. Replace components as needed.

☞ Driveline: Inspect the driveline for signs of wear such as worn drive yokes, dirty axle half shafts, and any unusual noise or binding. Remove the gear cover and inspect the spur gear for wear and check the tightness of set screws in the pinion gears. Tighten, clean, or replace components as needed.

Storage

When you are through running the model for the day, blow it off with compressed air or use a soft bristled paint brush to dust-off the vehicle. Always disconnect and remove the battery from the model whenever the model is stored. If the model will be stored for a long time, then also remove the batteries from the transmitter.

Keep this manual and the other documents included with your model for future reference. If you misplace your manual or any of the documents, they may be downloaded at Traxxas.com.

If you have any questions about your model or its operation, call the Traxxas Technical Support line toll-free at: **1-888-TRAXXAS (1-888-872-9927)***

Technical support is available Monday through Friday from 8:30am to 9:00pm central time.

If you have questions or need technical assistance, call Traxxas at

1-888-TRAXXAS

(1-888-872-9927) (U.S. residents only)



Your Traxxas transmitter has a programmable Multi-Function knob that can be set to control various advanced transmitter functions (set to Steering Sensitivity by default, see page 15). Accessing the programming menu is done by using the menu and set buttons on the transmitter and observing signals from the LED. An explanation of the menu structure follows on page 29. Experiment with the settings and features to see if they can improve your driving experience.

Throttle Sensitivity (Throttle Exponential)

The Multi-Function knob can be set to control Throttle Sensitivity. Throttle Sensitivity works the same way as Steering Sensitivity as described on page 15, but applies the effect to the throttle channel. Only forward throttle is affected; brake/reverse travel remains linear regardless of the Throttle Sensitivity setting.

Steering Percentage (Dual Rate)

The Multi-Function knob can be set to control the amount (percentage) of servo travel applied to steering. Turning the Multi-Function knob fully clockwise will deliver maximum steering throw; turning the knob counter-clockwise reduces steering throw (note: turning the dial counter-clockwise to its stop will eliminate all servo travel). Be aware that the steering End Point settings define the servo's maximum steering throw. If you set Steering Percentage to 100% (by turning the Multi-Function knob fully clockwise), the servo will travel all the way to its selected end point, but not past it. Many racers set Dual Rate so they have only as much steering throw as they need for the track's tightest turn, thus making the car easier to drive throughout the rest of the course. Reducing steering throw can also be useful in making a car easier to control on high-traction surfaces, and limiting steering output for oval racing where large amounts of steering travel are not required.

Braking Percentage

The Multi-Function knob may also be set to control the amount of brake travel applied by the servo in a nitro-powered model. Electric models do not have a servo-operated brake, but the Braking Percentage function still operates the same way in electric models. Turning the Multi-Function knob full clockwise will deliver maximum brake throw; turning the knob counter-clockwise reduces brake throw (**Note:** Turning the dial counter-clockwise to its stop will eliminate all brake action).

Throttle Trim

Setting the Multi-Function knob to serve as throttle trim will allow you to adjust the throttle's neutral position to prevent unwanted brake drag or throttle application when the transmitter trigger is at neutral. **Note:** Your transmitter is equipped with a Throttle Trim Seek mode to prevent accidental runaways. See the sidebar for more information.

Steering and Throttle End Points

The TQ 2.4GHz transmitter allows you to choose the limit of the servo's travel range (or its "end point") independently for left and right travel (on the steering channel) and throttle/brake travel (on the throttle channel). This allows you to fine-tune the servo settings to prevent binding caused by the servo moving steering or throttle linkages (in the case of a nitro car) farther than their mechanical limits. The end point adjustment settings you select will represent what you wish to be the servo's maximum travel; the Steering Percentage or Braking Percentage functions will not override the End Point settings.

Steering and Throttle Sub-Trim

The Sub-Trim function is used to precisely set the neutral point of the steering or throttle servo in the event that simply setting the trim knob to "zero" does not completely center the servo. When selected, Sub-Trim allows finer adjustment to the servo output shaft's position for precise setting of the neutral point. Always set the Steering Trim knob to zero before making final adjustment (if required) using Sub-Trim. If Throttle Trim has been previously adjusted, the Throttle Trim will need to be reprogrammed to "zero" before making final adjustment using Sub-Trim.

Setting Lock

Once you've adjusted all of these settings the way you like them, you may want to disable the Multi-Function knob so none of your settings can be changed. This is especially handy if you operate multiple vehicles with a single transmitter via Traxxas Link.

Multiple Settings and the Multi-Function Knob

It is important to note that settings made with the Multi-Function knob are "overlaid" on top of each other. For example, if you assign the Multi-Function to adjust Steering Percentage and set it for 50%, then reassign the knob to control Steering Sensitivity, the transmitter will "remember" the Steering Percentage setting. Adjustments you make to Steering Sensitivity will be applied to the 50% steering throw setting you selected previously. Likewise, setting the Multi-Function knob to "disabled" will prevent the knob from making further adjustments, but the last setting of the Multi-Function knob will still apply.

TRAXXAS LINK

Traxxas Link is an exclusive, patent-pending feature of the TQ 2.4GHz transmitter. Each time the transmitter is bound to a new receiver, it saves that receiver in its memory along with all the settings assigned to that receiver. When the transmitter and any bound receiver are switched on, the transmitter automatically recalls the settings for that receiver. There is no need to manually select your vehicle from a list of model memory entries.



Starting Over: Restoring Factory Defaults

When programming your 2.4GHz transmitter, you may feel the need to start over with a clean slate. Follow these simple steps to restore the factory settings:

1. Turn transmitter off.
2. Hold both MENU and SET.
3. Turn transmitter on.
4. Release MENU and SET.
The transmitter LED will blink red.
5. Press SET to clear settings.
The LED will turn solid green and the transmitter is restored to default.



Throttle Trim Seek Mode

When the Multi-Function knob is set to throttle trim, the transmitter remembers the throttle trim setting. If the throttle trim knob is moved from the original setting while the transmitter is off, or while the transmitter was used to control another model, the transmitter ignores the actual position of the trim knob. This prevents the model from accidentally running away. The LED on the face of the transmitter will rapidly blink green and the throttle trim knob (Multi-Function knob) will not adjust the trim until it is moved back to its original position saved in memory. To restore throttle trim control, simply turn the multi-function knob either direction until the LED stops blinking.

**Failsafe**

Your Traxxas radio system is equipped with a built-in failsafe function that returns the throttle to its last saved neutral position in the event of a signal loss. The LED on the transmitter and the receiver will rapidly flash red.

Model Lock

The Traxxas Link feature can store up to twenty models (receivers) in its memory. If you bind a twenty-first receiver, Traxxas Link will delete the “oldest” receiver from its memory (in other words, the model you used the longest time ago will be deleted). Activating Model Lock will lock the receiver in memory so it cannot be deleted.

You may also bind multiple Traxxas Link transmitters to the same model making it possible to pick up any transmitter and any previously bound model in your collection and simply turn them on and drive. With Traxxas Link, there is no need remember which transmitter goes with which model and there is never a need to have to select any model from a list of model memory entries. The transmitter and receiver do it all for you automatically.

To activate Model Lock:

1. Switch on the transmitter and receiver you wish to lock.
2. Press and hold MENU. Release when the status LED blinks green.
3. Press MENU three times. The status LED will blink green four times repeatedly.
4. Press SET. The status LED will blink green in single-flash intervals.

5. Press SET once. The status LED will blink red once repeatedly.
6. Press MENU once, the LED will blink red twice repeatedly.
7. Press SET, the LED will blink rapidly green. The memory is now locked. Press MENU and SET to return to driving mode.

Note: To unlock a memory, press SET twice at step 5. The LED will blink rapidly green to indicate the model is unlocked. To unlock all models, press MENU twice at step 6 and then press SET.

To delete a model:

At some point, you may wish to delete a model you no-longer drive from the memory.

1. Switch on the transmitter and receiver you wish to delete.
2. Press and hold MENU. Release when the status LED blinks green.
3. Press MENU three times. The status LED will blink green four times repeatedly.
4. Press SET once. The status LED will blink green once repeatedly.
5. Press MENU once. The status LED will blink green twice repeatedly.
6. Press SET. The memory is now selected to be deleted. Press SET to delete the model. Press and hold MENU to return to driving mode.

TRANSMITTER LED CODES

LED Color / Pattern	Name	Notes
Solid green	Normal Driving Mode	See page 13 for information on how to use your transmitter controls.
Slow red (0.5 sec on / 0.5 sec off)	Binding	See page 15 for more information on binding.
Flashing fast green (0.1 sec on / 0.15 sec off)	Throttle Trim Seek Mode	Turn the Multi Function knob right or left until the LED stops flashing. See page 27 for more information.
Flashing medium red (0.25 sec on / 0.25 sec off)	Low Battery Alarm	Put new batteries in the transmitter. See page 11 for more information.
Flashing fast red (0.125 sec on / 0.125 sec off)	Link Failure / Error	Transmitter and receiver are no longer bound. Turn the system off and then back on to resume normal operation. Find source of the link failure (ie out of range, low batteries, damaged antenna).
Programming Patterns		
Counts out number (green or red) then pauses	Current menu position	See Menu Tree for more information.
Fast green 8 times	Menu setting accepted (on SET)	
Fast red 8 times	Menu SET invalid	User error such as trying to delete a locked model.

RECEIVER LED CODES

LED Color / Pattern	Name	Notes
Solid green	Normal Driving Mode	See page 13 for information on how to use your transmitter controls.
Slow red (0.5 sec on / 0.5 sec off)	Binding	See page 15 for more information on binding.
Flashing fast red (0.125 sec on / 0.125 sec off)	Fail-Safe / Low-Voltage Detect	Consistent low-voltage in the receiver triggers Fail-Safe so there is enough power to center the throttle servo before it completely loses power.

MENU TREE

The menu tree below shows how to navigate through the TQ 2.4GHz transmitter's various settings and functions. Press and hold MENU to enter the menu tree, and use the following commands to navigate through the menu and select options.

MENU: When you enter a menu, you always start at the top. Press MENU to move down the menu tree. When you reach the bottom of the tree, pressing MENU again will return you to the top.

SET: Press SET to move across the menu tree and select options. When an option is committed to the transmitter's memory, the status LED will rapidly blink green.

BACK: Press both MENU and SET to go back one level in the menu tree.

EXIT: Press and hold MENU to exit programming. Your selected options will be saved.

ECHO: Press and hold SET to activate the "echo" function. Echo will "play back" your current position on the Menu Tree, should you lose your place. For example: If your current position is Steering Channel End Points, holding SET will cause the LED to blink green twice, green once, and then red three times. Echo will not alter your adjustments or change your position in the programming sequence.

Below is an example of how to access a function in the menu tree. In the example, the user is setting the Multi-Function knob to be a steering Dual Rate control.

- To set the Multi-Function knob to control STEERING DUAL RATE (%):
1. Switch the transmitter on
 2. Press and hold MENU until the green LED lights. It will blink in single intervals.
 3. Press SET. The red LED will blink in single intervals to indicate Steering Dual Rate has been selected.
 4. Press MENU twice. The red LED will blink three times repeatedly to indicate Steering Percentage has been selected.
 5. Press SET to select. The green LED will blink 8 times fast to indicate successful selection.
 6. Press and hold MENU to return to driving mode.

Restoring Factory Defaults:

Transmitter OFF	Hold both MENU and SET	Transmitter ON	Release MENU and SET red LED blinks	Press SET to clear settings. LED will turn solid green. Transmitter is restored to default
-----------------	------------------------	----------------	--	--

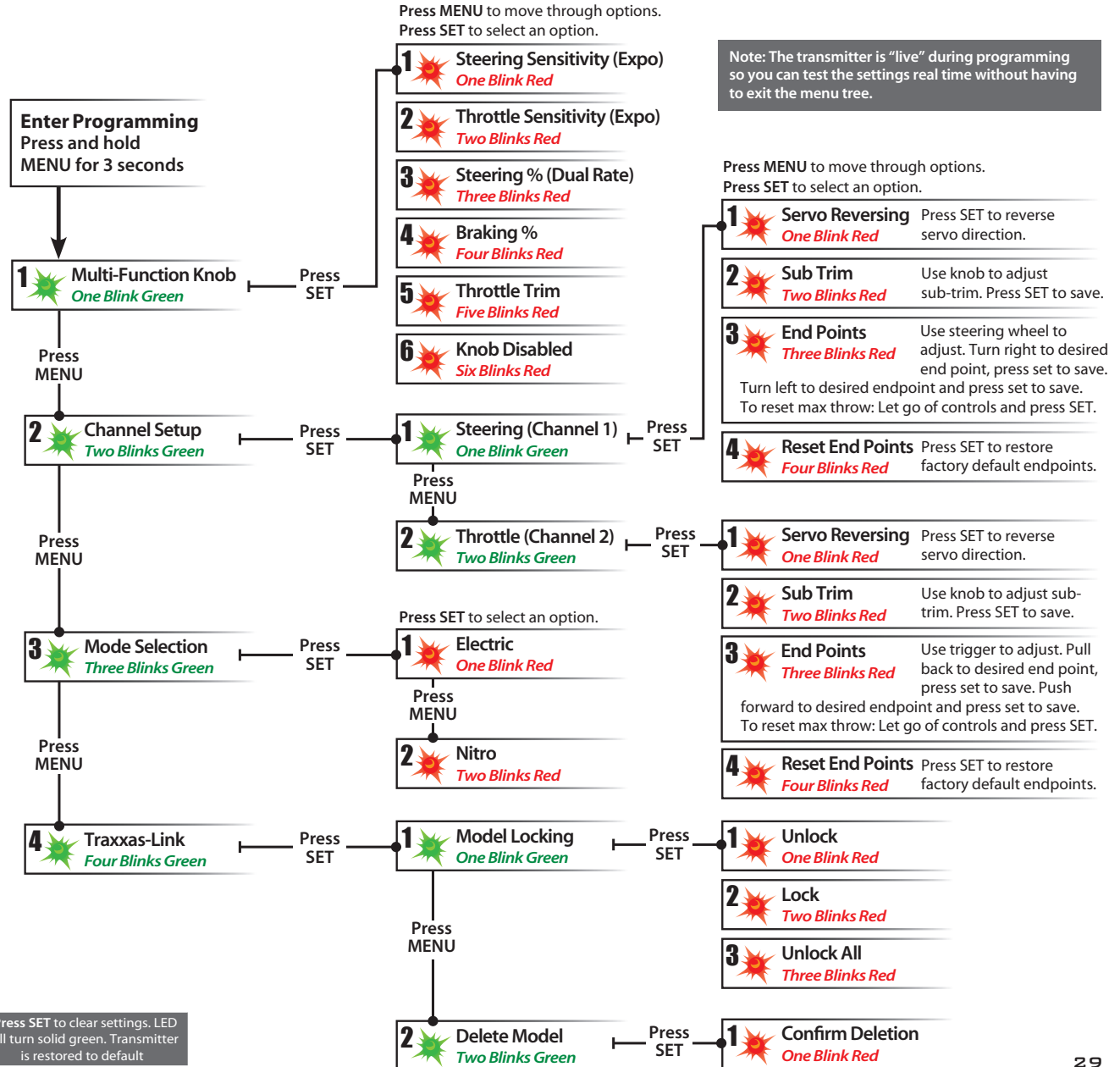



TRAXXAS RALLY

MODEL 7307

TRAXXAS

OWNER'S MANUAL

1100 KLEIN ROAD, PLANO TEXAS 75074

1-888-TRAXXAS