

OWNER'S INSTRUCTION MANUAL

It is of vital importance, before attempting to operate your engine, to read the general **'SAFETY INSTRUCTIONS AND WARNINGS'** section on pages 2-4 of this booklet and to strictly adhere to the advice contained therein.

- Also, please study the entire contents of this instruction manual, so as to familiarize yourself with the controls and other features of the engine.
- Keep these instructions in a safe place so that you may readily refer to them whenever necessary.
- It is suggested that any instructions supplied with the aircraft, radio control equipment, etc., are accessible for checking at the same time.



Five-cylinder radial overhead-valve four-stroke engine

CONTENTS

SAFETY INSTRUCTIONS AND WARNINGS ABOUT YOUR O.S. ENGINE	2-4	FLIGHT	22
INTRODUCTION, TOOLS AND ACCESSORIES	5	CARE AND MAINTENANCE	22
ENGINE PARTS NAME	6-7	VALVE CLEARANCE ADJUSTMENT	23-25
INSTALLATION	8-9	ENGINE EXPLODED VIEW	26
PROPELLER	10-11	ENGINE PARTS LIST	27
GLOWPLUGS	12	CARBURETOR EXPLODED VIEW & PARTS LIST	28
GLOWPLUG HEATING	13-14	ASSEMBLY OF FR5-300 DISPLAY STAND	29
FUEL AND LUBRICATION, STARTING	14-18	O.S. GENUINE PARTS & ACCESSORIES	30
RUNNING-IN ("Breaking-in")	18-19	ENGINE THREE VIEW DRAWINGS	31
THROTTLE VALVE ADJUSTMENT	19-21		

SAFETY INSTRUCTIONS AND WARNINGS ABOUT YOUR O.S. ENGINE

Remember that your engine is not a "toy", but a highly efficient internal-combustion machine whose power is capable of harming you, or others, if it is misused or abused. As owner, you, alone, are responsible for the safe operation of your engine, so act with discretion and care at all times.

If at some future date, your O.S. engine is acquired by another person, we would respectfully request that these instructions are also passed on to its new owner.

- The advice which follows is grouped under two headings according to the degree of damage or danger which might arise through misuse or neglect.





WARNINGS

These cover events which might involve serious (in extreme circumstances, even fatal) injury.

NOTES

These cover the many other possibilities, generally less obvious sources of danger, but which, under certain circumstances, may also cause damage or injury.

WARNINGS

- Never touch, or allow any object to come into contact with, the rotating propeller and do not crouch over the engine when it is running. 
- A weakened or loose propeller may disintegrate or be thrown off and, since propeller tip speeds with powerful engines may exceed 600 feet(180 metres) per second, it will be understood that such a failure could result in serious injury, (see 'NOTES' section relating to propeller safety).
- Model engine fuel is poisonous. Do not allow it to come into contact with the eyes or mouth. Always store it in a clearly marked container and out of the reach of children. 
- Model engine fuel is also highly flammable. Keep it away from an open flame, excessive heat, sources of sparks, or anything else which might ignite it. Do not smoke or allow anyone else to smoke, near to it. 
- Never operate your engine in an enclosed space. Model engines, like automobile engines, exhaust deadly carbon-monoxide. Run your engine only in an open area.
- Model engines generate considerable heat. Do not touch any part of your engine until it has cooled. Contact with the muffler(silencer), cylinder head or exhaust header pipe, in particular, may result in a serious burn. 

2

NOTES

- This engine was designed for model aircraft. Do not attempt to use it for any other purpose.
- Mount the engine in your model securely, following the manufacturers' recommendations, using appropriate screws and locknuts.
- Be sure to use the silencer (muffler) supplied with the engine. Frequent exposure to an open exhaust may eventually impair your hearing. Such noise is also likely to cause annoyance to others over a wide area.
- If you remove the glowplug from the engine and check its condition by connecting the battery leads to it, do not hold the plug with bare fingers. Use an appropriate tool or a folded piece of cloth.
- Install a top-quality propeller of the diameter and pitch specified for the engine and aircraft. Locate the propeller on the shaft so that the curved face of the blades faces forward-i.e. in the direction of flight. Firmly tighten the propeller nut, using the correct size wrench.
- Always check the tightness of the propeller nut and retighten it, if necessary, before restarting the engine, particularly in the case of four-stroke-cycle engines. If a safety locknut assembly is provided with your engine, always use it. This will prevent the propeller from flying off in the event of a "backfire", even if it loosens. Also, check the tightness of all the screws and nuts before restarting the engine.
- If you install a spinner, make sure that it is a precision made product and that the slots for the propeller blades do not cut into the blade roots and weaken them.
- Discard any propeller which has become split, cracked, nicked or otherwise rendered unsafe. Never attempt to repair such a propeller: destroy it. Do not modify a propeller in any way, unless you are highly experienced in tuning propellers for specialized competition work such as pylon-racing.

3

! NOTES

- Use an electric starter for this engine. The wearing of safety glasses is also strongly recommended.
- Take care that the glow plug clip or battery leads do not come into contact with the propeller. Also check the linkage to the throttle arm. A disconnected linkage could also foul the propeller.
- After starting the engine, carry out any needle-valve readjustments from a safe position behind the rotating propeller. Stop the engine before attempting to make other adjustments to the carburetor.
- Adjust the throttle linkage so that the engine stops when the throttle stick and trim lever on the transmitter are fully retarded. Alternatively, the engine may be stopped by cutting off the fuel supply. Never try to stop the engine physically.
- Take care that loose clothing (ties, shirt sleeves, scarves, etc.) do not come into contact with the propeller. Do not carry loose objects (such as pencils, screwdrivers, etc.) in a shirt pocket from where they could fall through the propeller arc.
- Do not start your engine in an area containing loose gravel or sand. The propeller may throw such material in your face and eyes and cause injury.
- For their safety, keep all onlookers (especially small children) well back (at least 20 feet or 6 meters) when preparing your model for flight. If you have to carry the model to the take-off point with the engine running, be especially cautious. Keep the propeller pointed away from you and walk well clear of spectators.
- **Warning!** Immediately after a glowplug-ignition engine has been run and is still warm, conditions sometimes exist whereby it is just possible for the engine to abruptly restart if the propeller is casually flipped over compression **WITHOUT** the glowplug battery being reconnected. Remember this if you wish to avoid the risk of a painfully rapped knuckle!

4

INTRODUCTION

The O.S. Sirius (FR5-300) is a five-cylinder radial overhead-valve four-stroke engine of 49.75cc (3.04cu.in) total displacement. The FR5-300 has been designed to meet the requirements of those whose interests lie in the field of very large radio-controlled aircraft and who demand the high standards of refinement that are not available in large displacement two-stroke engines based on chainsaw and other light commercial power units.

TOOLS AND ACCESSORIES

Please ignore the listing of the original instructions manual. The following tools and accessories are supplied with your engine.

No.	Description	Quantity
1	Radial Motor Mount Set	
	Radial Motor Mount(installed on the engine)	1
	Mount attachment screws	5
1-1	Engine mounting screws (M5X25)	5
1-2	Lock washers (ø5)	5
1-3	Blind nuts (M5)	5
2	Set of leads for wiring glow plugs	
2-1	Leads for glow plug with clip	5
2-2	Lead for earth (ground)	1
3	Woodruff key	1
4	Valve adjusting tool kit	1
5	Choke valve rod	1
6	Drain plug	1
7	Display Stand	1

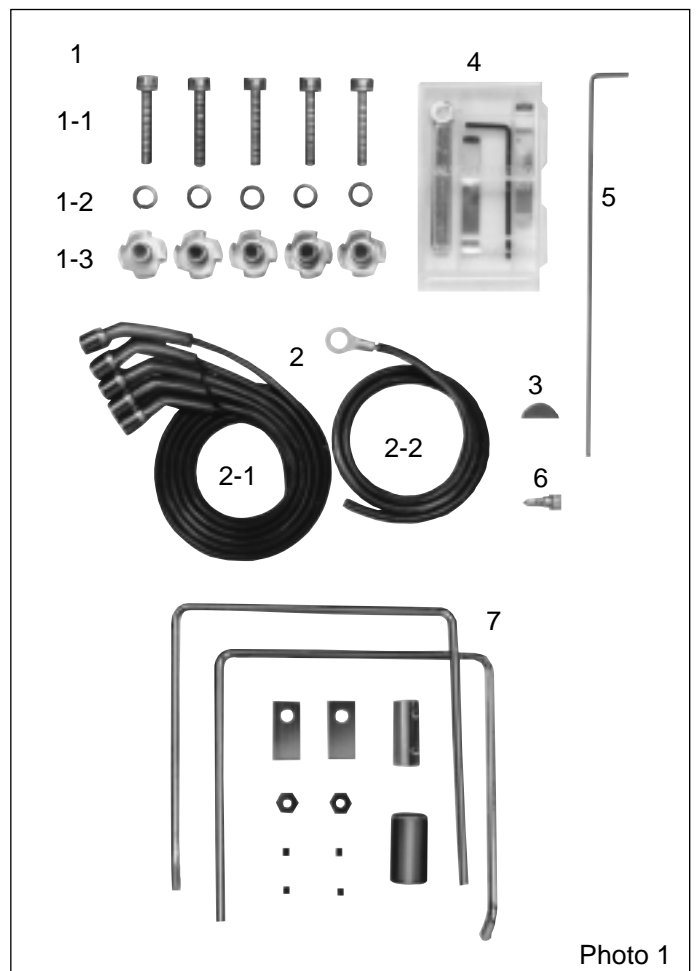
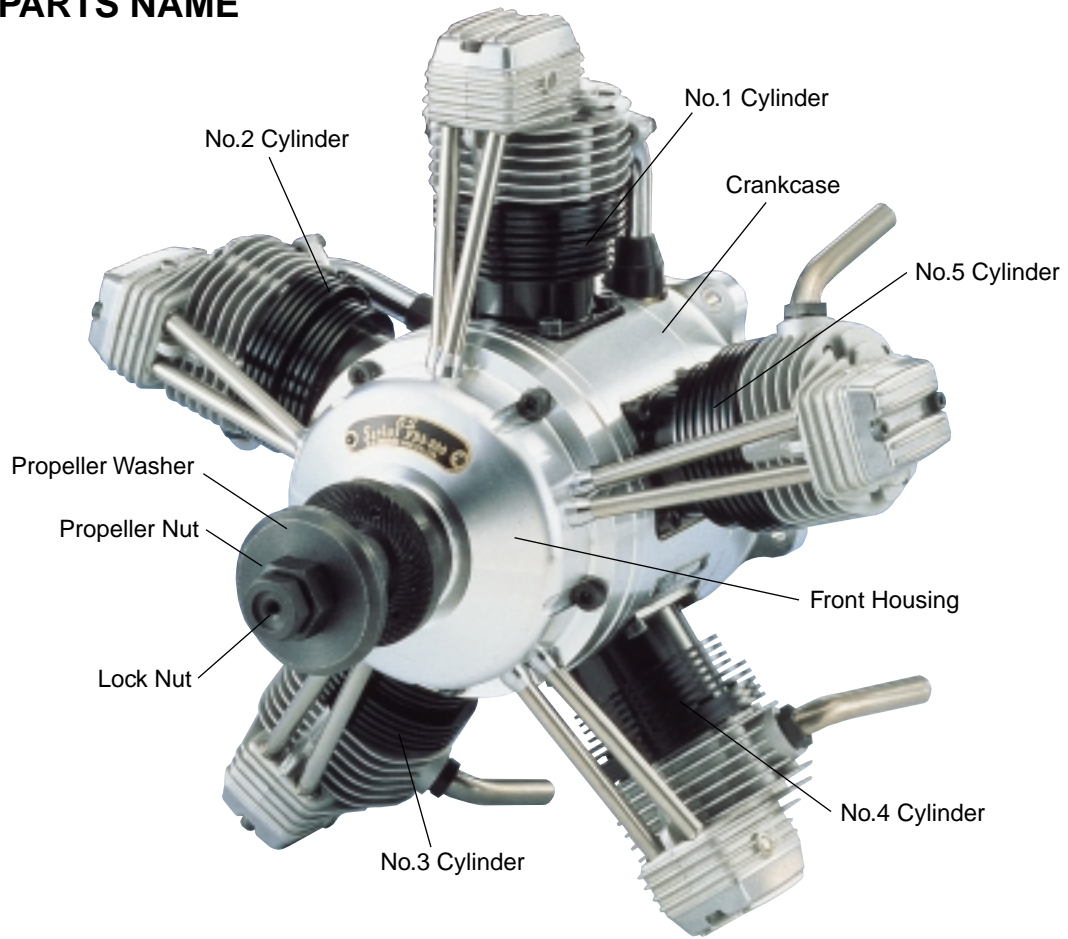

Photo 1

ENGINE PARTS NAME

Photo. 2



6

Photo. 3

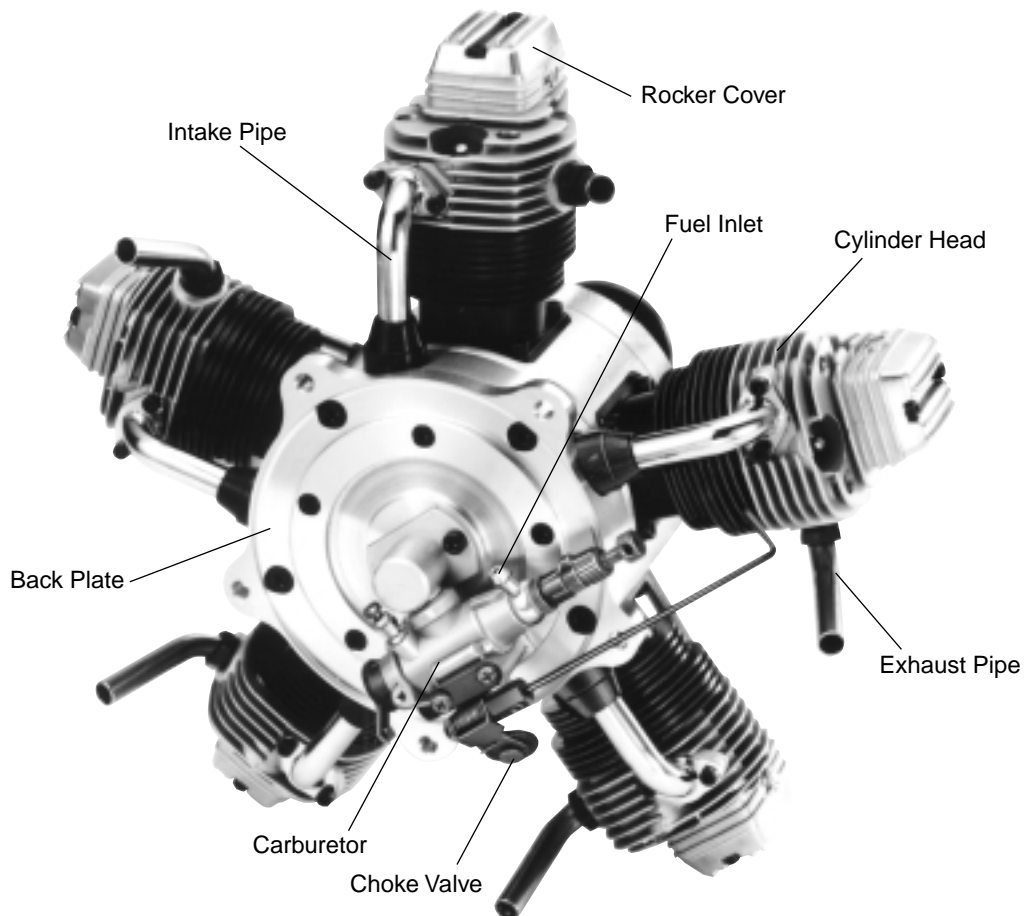

7

INSTALLATION

- The FR5-300 is equipped with a strong cast aluminum radial-type mount to enable it to be bolted securely to the firewall (front bulkhead) of the aircraft.
- It is essential that the firewall is strong and rigid (e.g. at least 15mm thick) and firmly integrated with the structure of the aircraft.
- Installation procedure is as follows.
 1. Draw center lines and 61mm radius (4-13/16" dia.) circle on the firewall.
 2. Remove the mount from the engine and align it with the firewall as illustrated. Mark and drill holes for 5mm screws (M5x25)
 3. Secure the mount to the firewall by means of the screws, nuts and washers supplied.
 4. Install the engine using the screws supplied so that the nameplate on the front housing is located at the top.

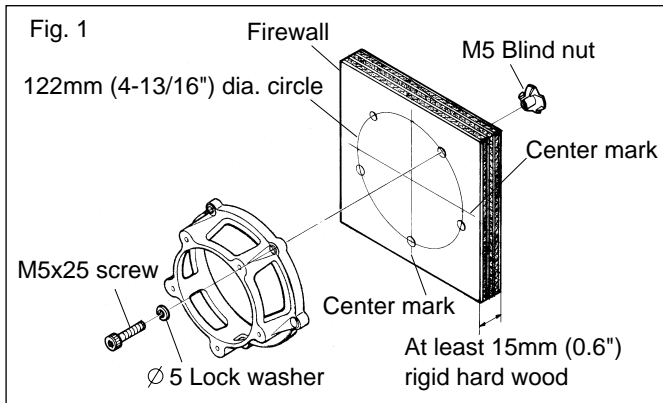

Needle-valve extension

- The needle-valve with this engine is designed to incorporate an extension so that, when the engine is enclosed within the fuselage, the needle-valve may be adjusted from the outside. An L-shaped rod, of 1.6-1.8mm dia. and appropriate length, should be inserted into the needle's center hole and secured by tightening the set-screw in the needle-valve knob with the small Allen key provided. For longer extension, it is recommended to use the extension cable with the engine, together with the knob and support hook also. For this purpose, Needle Valve Extension Cable Set (Code No. 72200080) is available as an optional part.
- Do not use an excessively long unsupported extension as this may vibrate and cause the needle-valve setting to vary or even damage the needle-valve thread. Always provide a suitable support at the outer end.

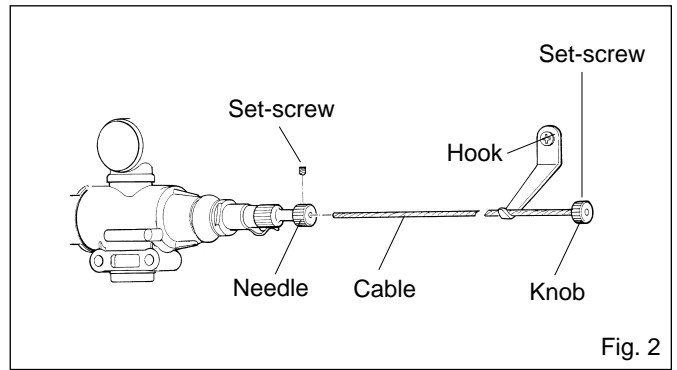

8

Choke valve

The choke valve operating lever can be located right or left by reversing the hexagon nut and cap screw.

- Unscrew the cap screw while holding the hexagon nut with 6mm wrench, and re-fit the lever to required location.
- If the rod is too long, reduce it to required length.
- A needlessly lengthy rod may vibrate. The rod should be as short as possible or have its outer end supported.

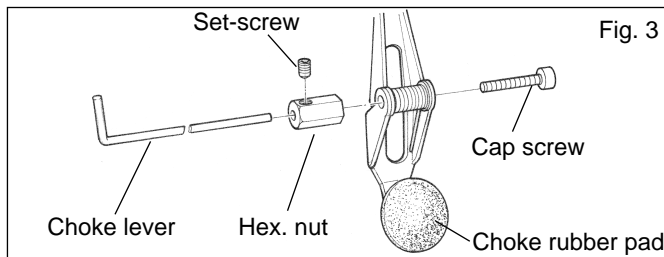

Fuel inlet

The fuel inlet nipple on the carburetor can be adjusted to the most suitable position for connecting to the fuel delivery tube from the tank. Slacken the needle-valve holder with the 8mm wrench provided, reset the inlet nipple at the required angle and re-tighten.

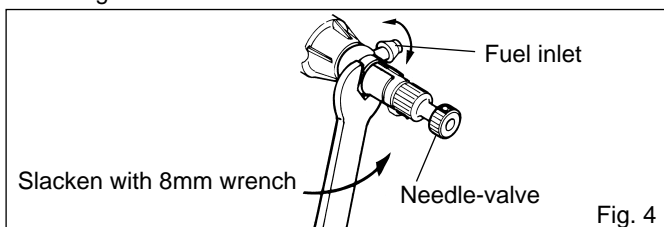

Exhaust pipe adjustment

- The direction of the exhaust pipes may be altered in accordance with individual installation requirements. The angle is easily adjusted by loosening the nut that secures the exhaust pipe to the cylinder head. Use the 12mm wrench supplied.

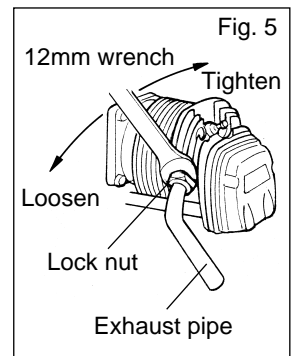

Carburetor cleanliness

- It is recommended that the fuel is passed through a filter when the tank is filled and that a good in-line filter is installed between the fuel tank and carburetor.
- Occasionally remove the needle-valve holder from the carburetor and rinse out the locations shown in Fig. 6 and Fig. 7 with methanol or fuel. Be careful not to lose the gasket when removing the needle-valve holder from the carburetor.

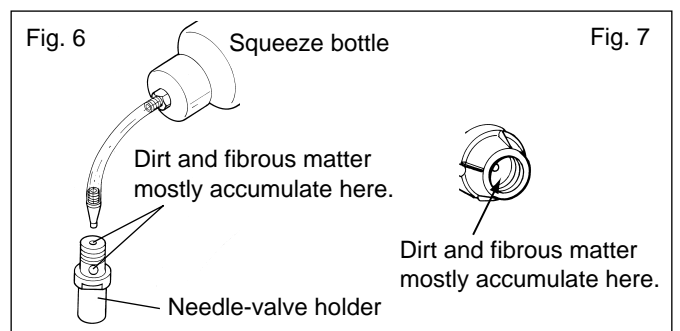

9

PROPELLER

The choice of propeller depends on the design and weight of the aircraft and on the type of flying in which you will be engaged. Determine the best size and type after practical experimentation. As a starting point, refer to the props listed in the accompanying table. Slightly larger, or even slightly smaller, props than those shown in the table may be used, but remember that propeller noise will increase if blade tip velocity is raised, due to higher rpm or if a larger-diameter / lower-pitch prop is used.

Warning:

Make sure that the propeller is well balanced. An unbalanced propeller and / or spinner can cause serious vibration which may weaken parts of the airframe or affect the safety of the radio-control system.

DO NOT forget the WARNINGS and NOTES on propeller and spinner safety given on pages 2,3 and 4.

Type	Size (DxP)
Sport/Scale	18x10-12, 20x8-10, 22x8

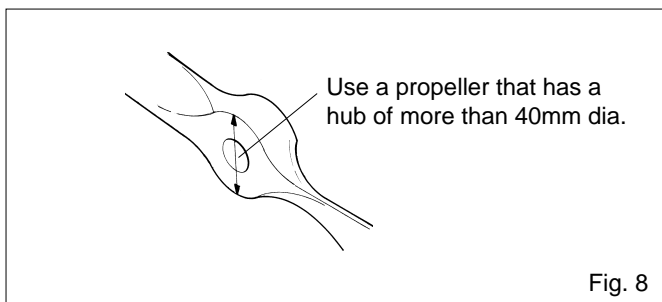

10

2. Install the prop to the engine shaft, followed by the retaining washer and prop nut and tighten firmly with a 17mm wrench. (not supplied).
3. Add the special tapered and slotted locknut and secure with a 12mm wrench while holding the prop nut with the 14mm wrench. (not supplied).

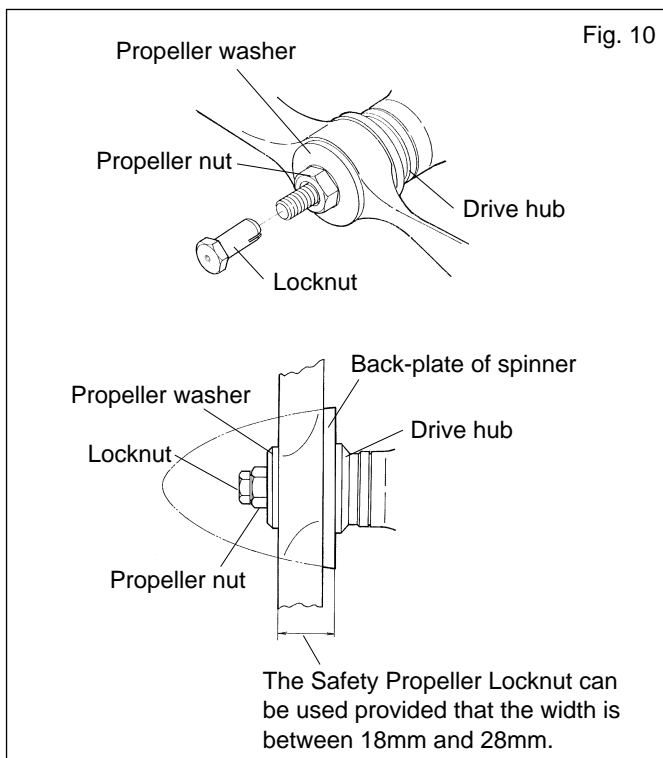

PROPELLER & SPINNER ATTACHMENT

There is a risk, particularly with powerful four-stroke engines, of the propeller flying off if the prop nut loosens due to detonation ("knocking") in the combustion chamber when the engine is operated too lean, or under an excessively heavy load.

Obviously, this can be very hazardous. To eliminate such dangers, the O.S. Safety Locknut Assembly was devised.

Install this as follows:

1. Ream the propeller shaft hole to 13.4mm bore with an appropriate reamer, checking that the hole is exactly centered.

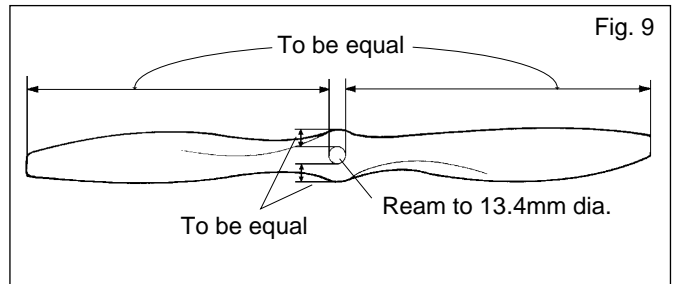

NOTE:

Make a habit of always checking the tightness of the propeller before starting the engine. Remember that, especially with wooden propellers, there is a tendency for the material to shrink, or for it to be reduced by the serrated face of the drive hub. Retighten the propeller nut if necessary after loosening the Safety Propeller Locknut. The locknut should be tightened firmly after retightening the propeller nut.

SPINNER

Since this engine can only be started using an electric starter, please install a spinner. Although the spinner may be made of metal or plastic, make sure that it is properly balanced and has adequate strength. In addition, since the propeller and spinner may be damaged if the notches in the spinner make contact with the base of the propeller, install the spinner after having first ground it to ensure sufficient clearance.

GLOWPLUGS

The FR5-300 is supplied with five O.S. Type F glowplugs, specially designed for O.S. four-stroke engines.

The role of the glowplug

With a glowplug engine, ignition is initiated by the application of a 1.5-volt power source. When the battery is disconnected, the heat retained within the combustion chamber remains sufficient to keep the plug filament glowing, thereby continuing to keep the engine running. Ignition timing is 'automatic' : under reduced load, allowing higher rpm, the plug becomes hotter and, appropriately, fires the fuel/air charge earlier; conversely, at reduced rpm, the plug becomes cooler and ignition is retarded.

Glowplug life

Particularly in the case of very high performance engines, glowplugs must be regarded as expendable items.

However, plug life can be extended and engine performance maintained by careful use, i.e.:

- Install a plug suitable for the engine.
- Use fuel containing a moderate percentage of nitromethane unless more is essential for racing events.
- Do not run the engine too lean and do not leave the battery connected while adjusting the needle.

When to replace the glowplug

Apart from when actually burned out, a plug may need to be replaced because it no longer delivers its best performance, such as when:

- Filament surface has roughened and turned white.
- Filament coil has become distorted.
- Foreign matter has adhered to filament or plug body has corroded.
- Engine tends to cut out when idling.
- Starting qualities deteriorate.

12

GLOWPLUG HEATING

Glowplug battery

It is necessary to use a glowplug battery of fairly large capacity (10Ah or more) as this is required to heat five glowplugs simultaneously.

A heavy-duty 1.5-volt dry battery or (preferably) 1.2-volt Ni-Cd battery may be used.

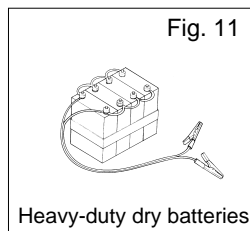

A 2-volt lead-acid cell (accumulator) may also be used but only if provision is made for reducing the voltage at the plugs since these are nominally rated at 1.5-volt. See notes below.

The five glowplug leads supplied with the engine should be brought together (Fig.14) and connected to a conveniently located common external point on the fuselage. This can either be a terminal with a separate terminal for the earth (ground) lead (Fig.12) or a suitable socket or jack with connections for both glowplug and earth (ground) leads (Fig.12) . Note that the earth (ground) lead supplied is much heavier (2.0 mm² multi-strand copper core) than the plug leads as this has to have the capacity to carry the current for all five plugs. Similar wire should be used if a single lead is employed to extend the glowplug leads (Fig.14).

• Heavy-duty 1.5-volt dry battery

Use at least four heavy-duty cells wired in parallel (Fig.11) and with short heavy leads (to minimize voltage drop) to the connection point on the fuselage. The disadvantage of dry cells is that they cannot be recharged when their power diminishes and makes the engine difficult to start.

• Ni-Cd (nickel-cadmium) 1.2-volt rechargeable battery

Use a 10-Ah cell, or 8 to 10 1.2-Ah cells (as commonly used for electric-powered R/C cars) wired in parallel and with short heavy leads (to minimize voltage drop) to the connection point on the fuselage.

• Lead-acid 2-volt rechargeable cell

A lead-acid cell of 10-Ah (preferably greater) capacity is required. However, in this case, it is necessary to reduce the applied voltage at the glowplugs to approximately 1.5 volt. The recommended method is to insert a suitable resistor in each individual plug lead. It is possible, of course, to use a rheostat attached to the 2-volt cell, or to use extra long leads (at least 2 metres) to obtain the required voltage drop. However, the disadvantage of this method is that if one glowplug should fail or become disconnected, voltage to the other four will be increased with the risk of burning out their elements.

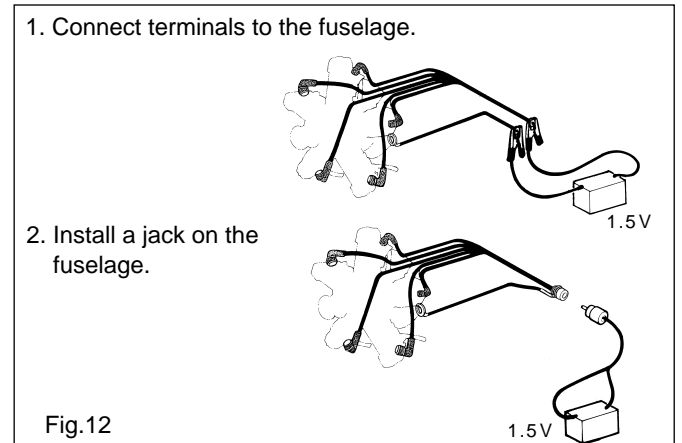

13

Glowplug leads

- The plug leads are fitted with special snap-on connectors that ensure firm contact with O.S. plug. They are a "click" fit and are not suitable for use with most other makes of glowplug.
- The earth (ground) lead is fitted with a plug terminal which should be connected to the engine by means of one of the mounting screws.
- Make sure that no part of the wiring touches the cylinder head or cooling fins.
- Keep wiring away from the fuel tank where it might cause a fire in the event of a short-circuit.

Install Ni-Cd battery in the fuselage, and switch on or off by means of transmitter. (On-board battery)

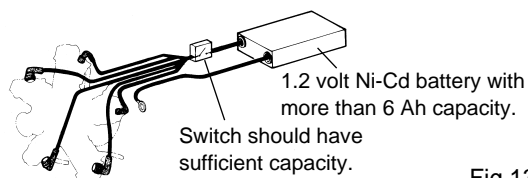

Fig.13

If glowplug leads are extended together as a single cable, use heavier wire, e.g. 2.0 mm² multi-strand copper core as supplied for earth lead.

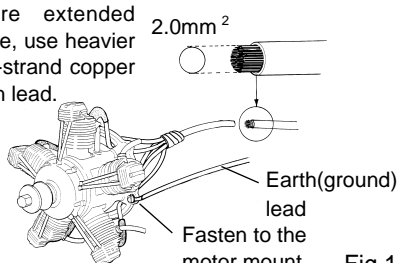

Fig.14

14

Lubrication

All parts of the FR5-300 are automatically lubricated by the oil content of the fuel mixture.

- The crankcase breather hole is located at the side of the engine and is fitted with a brass nipple. Fit a length of silicone tubing of approx. 2.5-3mm I.D. to this nipple to conduct away the small amount of oil that escapes through the breather.
- At the conclusion of the flying session, drain out the excess oil in the crankcase by removing the drain plug. While running the engine, the drain plug should always be installed. (See Photo 4 and Fig. 15)
- Make a habit of draining out the excess oil in the crankcase at the end of each flying session. Leaving contaminated oil in the crankcase for a long time will cause rust. Also, residual castor oil will tend to solidify and lock the engine. Inject corrosion-inhibiting oil into the crankcase to neutralize the effects of any remaining contaminants.

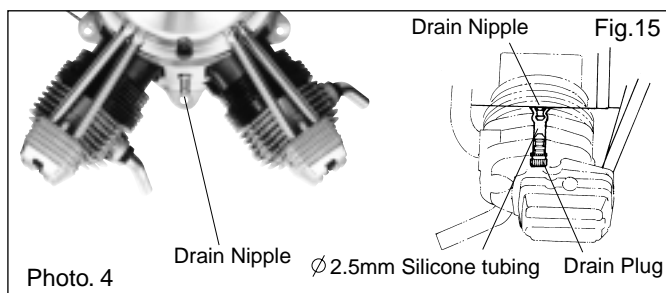

Photo. 4

Drain Nipple Fig.15

Glowplug re-heat

Under normal conditions, the FR5-300 will idle sufficiently slowly with the throttle closed to permit a safe landing approach. However, if conditions (atmospheric, fuel, tank location etc.) are unfavorable, there may be a tendency for one cylinder to cease firing if the engine is throttled down to a very low idling speed. This can be prevented by installing a small on-board Ni-Cd battery which will automatically re-heat the glowplugs when the engine is throttled down to idling speed (Fig.13). A suitable switch should be installed so that it is actuated by the throttle servo only when the engine is throttled down. Safe idling speeds of less than 2,000 rpm may be obtained in this way and without undue drain on the battery.

FUEL AND LUBRICATION

Fuel

The FR5-300 should be operated on a methanol based fuel containing not less than 18% (volumetric) castor oil, or a top quality synthetic lubricant (or a mixture of both), plus a small percentage (5-20%) of nitromethane for improved flexibility and power.

Reminder!

Model engine fuel is poisonous. Do not allow it to come into contact with the eyes or mouth. Always store it in a clearly marked container and out of the reach of children.

Model engine fuel is also highly flammable. Keep it away from open flame, excessive heat, sources of sparks, or anything else which might ignite it. Do not smoke, or allow anyone else to smoke, near to it.

STARTING

Precautions

For safety, please observe the following instructions before starting the engine.

- Start the engine by turning the propeller counter-clockwise (i.e. normal running direction).
- Do not start the engine with the throttle fully opened, otherwise the model will tend to move forward suddenly due to the strong thrust of the propeller. Hold both wings of the model when starting the engine.
- Do not carry out carburetor adjustments (except needle-valve adjustment) while engine is running.
- Use a high-torque electric starter.
- After the engine has been run, residual oil will tend to accumulate in the lower two cylinders. This also happens with full-size radial engines and, between flying sessions, this accumulation may be sufficient to prevent the pistons from passing over top dead center on the compression stroke i.e. a 'hydraulic lock' will occur. Any attempt to start the engine in this condition may cause serious damage. Make sure that such damage does not occur by first removing the glowplugs from No.3 and No.4 cylinders to allow the excess oil to drain out.

Starting procedure is as follows:

1. Open the needle-valve 2 to 3 turns from the fully closed position (Fig.16).

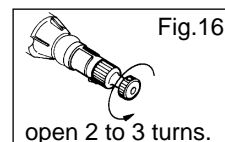
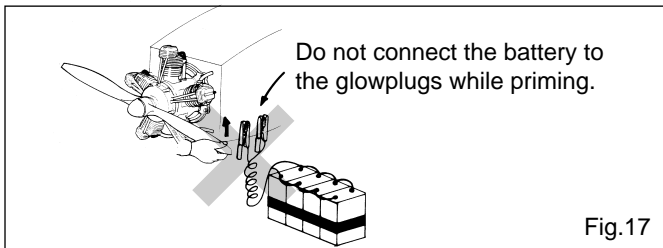
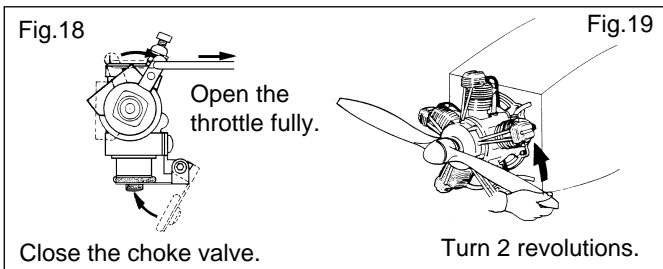

Fig.16

2. Make sure that glowplugs are not connected to the battery. Do not heat the glowplugs while priming. (Fig.17).



3. Open the throttle valve fully, close the choke valve and turn the propeller counter-clockwise through two revolutions. (Fig.19 & 20)



- If very strong compression is felt when trying to turn the propeller counter-clockwise, too much fuel has been drawn into the engine. In this case, do not use force, but release the choke valve and turn the propeller clockwise slowly to eject excess fuel through exhaust pipes.
- **Warning! Never close the choke valve when applying the starter. Such an action will cause an excess quantity of fuel to be drawn into the cylinders and result in hydraulic lock that may damage the engine. (Fig.20)**

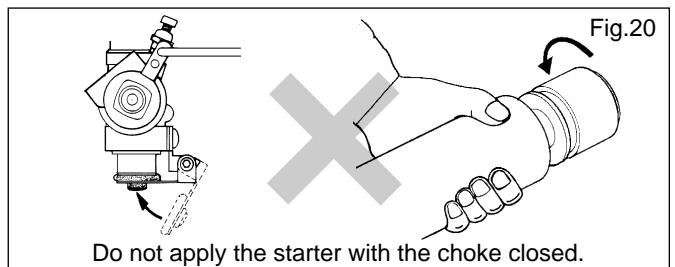

- Excess fuel in the carburetor may drip into the engine compartment when the choke valve is reopened. Therefore, it is advisable to drill a drain hole in the bottom of the engine bay or cowling and to apply fuelproof paint to the surrounding surfaces to prevent fuel from penetrating the airframe structure.

4. Release the choke control and immediately turn the propeller counter-clockwise several times so that fuel is drawn well into the cylinders (Fig.21).

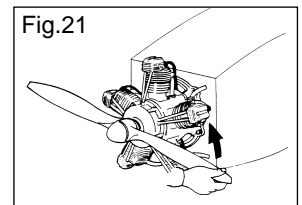

5. Set the throttle valve approximately 1/4 open from the fully closed position. (Fig.23).

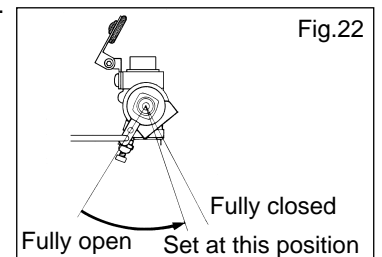

16

6. Starting with an electric starter (Fig.23)

- Make sure that the direction of rotation of the starter is correct.
- Connect the glowplug battery.
- Apply the electric starter.

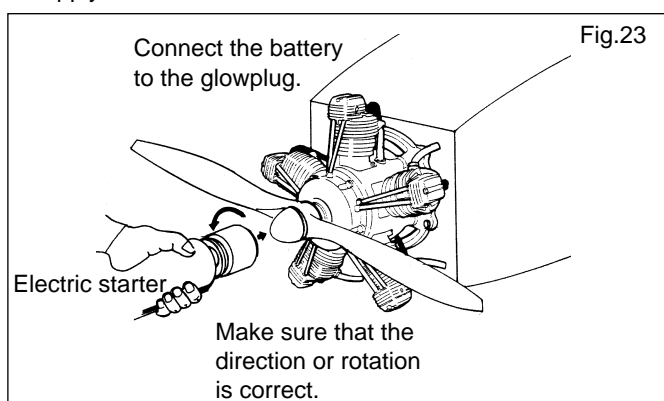

7. When the engine starts, open the throttle valve fully and keep it running initially (approx. 10 seconds), with original needle-valve setting.

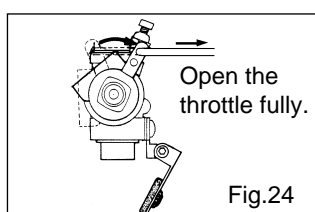

8. Make sure that all five cylinders are firing.

- The engine is running properly if white smoke is emitted through every exhaust pipes. A slight spray of fuel will be discharged through the exhaust pipe or any cylinder that is not firing.
- If a cylinder ceases firing, reduce the throttle setting to approximately 1/4 open from the fully closed position and re-connect the glowplug battery. The rpm will increase when all cylinders are firing steadily.

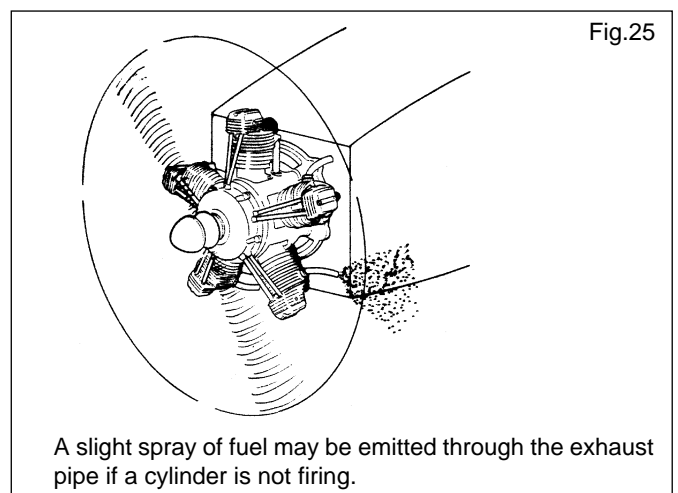

9. Now disconnect the glowplug battery.

17

10. Adjust the needle-valve

- Abrupt adjustment of the needle-valve may cause the engine to stop, especially when it is new and insufficiently run-in.
- As the speed of the engine does not instantly change with needle-valve readjustment, small movements, with pauses between, are necessary to arrive at the optimum setting.

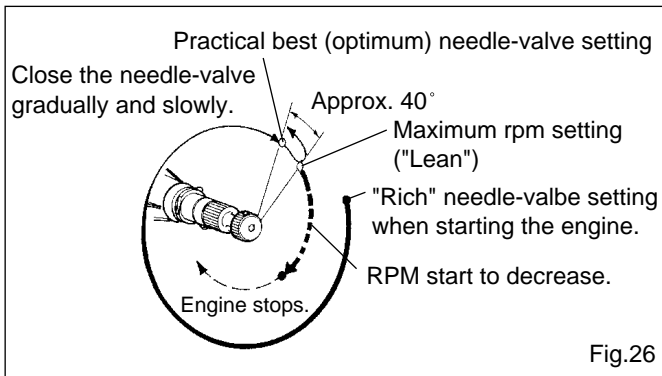

Re-starting the engine when warm

To re-start the engine when warm, simply re-energise the plugs and reapply the starter with the throttle in the idling position. If the engine does not start, disconnect the battery from the glowplugs and re-prime by closing the choke valve while rotating the propeller twice with the throttle open. Initially, the high temperature inside the combustion chambers may turn the liquid fuel into gas and emit it through the exhaust pipes. Therefore, repeat the priming procedure once or twice until the cylinders become cool enough for restarting.

18

2. Running-in in the air

Start the engine

Fly the model. Set the needle-valve approx 40° open from optimum position (approx. 40° open from maximum r.p.m.).

NOTE: Avoid prolonged heavy load flight.

With each successive flight, close the needle-valve slightly, until, at the end of 10 flights, the needle-valve is set for optimum position.

Finish running-in.

The carburetor can now be adjusted for optimum throttle performance following the instructions given in the next section.

THROTTLE VALVE ADJUSTMENT

Needle-valve adjustment

Adjust the needle-valve following the instructions given in STARTING section.

The carburetor of your FR5-300 has been factory set for the approximate best result with the fuel tank located in the normal position (i.e. close to the back of the engine and where the level of the needle-valve is at 2/3 height of the tank), but the setting may, in some cases, vary slightly in accordance with fuel and climatic conditions.

RUNNING-IN ("Breaking-in")

Obtain an 18x10 or 20x8 propeller for running-in.

1. Running-in on the ground

Start the engine

- 1 Set the needle-valve at 500-1,000r.p.m. lower than maximum r.p.m. setting and run approx. 10 seconds. (It is suggested to use a tachometer.)
- 2 Open the needle-valve at approx. 1,000r.p.m. lower than above setting and run approx. 20 seconds.

Repeat above procedure, i.e., richening and leaning the mixture until the engine has approx. 10 minutes of running time.

NOTE:

Keep the throttle fully open, using only the needle-valve to change r.p.m. Prolonged running-in on the ground is not suggested because the purpose is just initial running-in to increase engine temperature gradually close to that of maximum r.p.m.

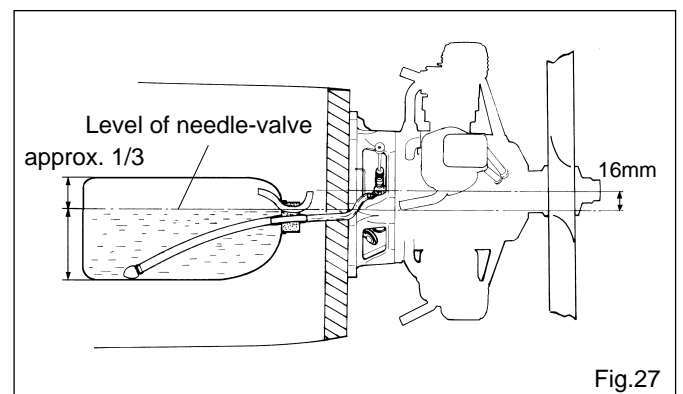
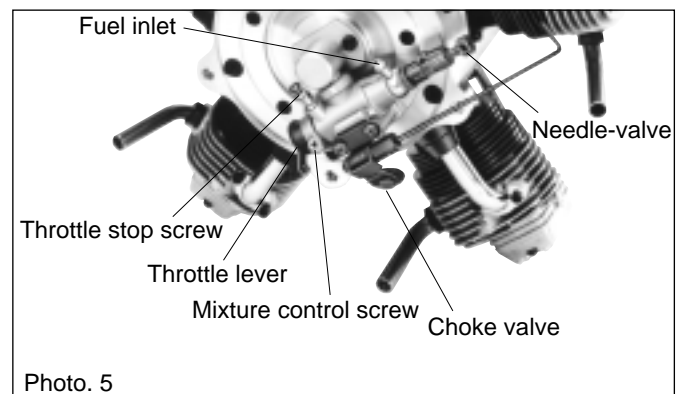

Mixture control valve adjustment

After running is completed and the needle-valve is set at optimum position (approx 40° open from maximum r.p.m. position), check the idle speed and adjust only when necessary.

19

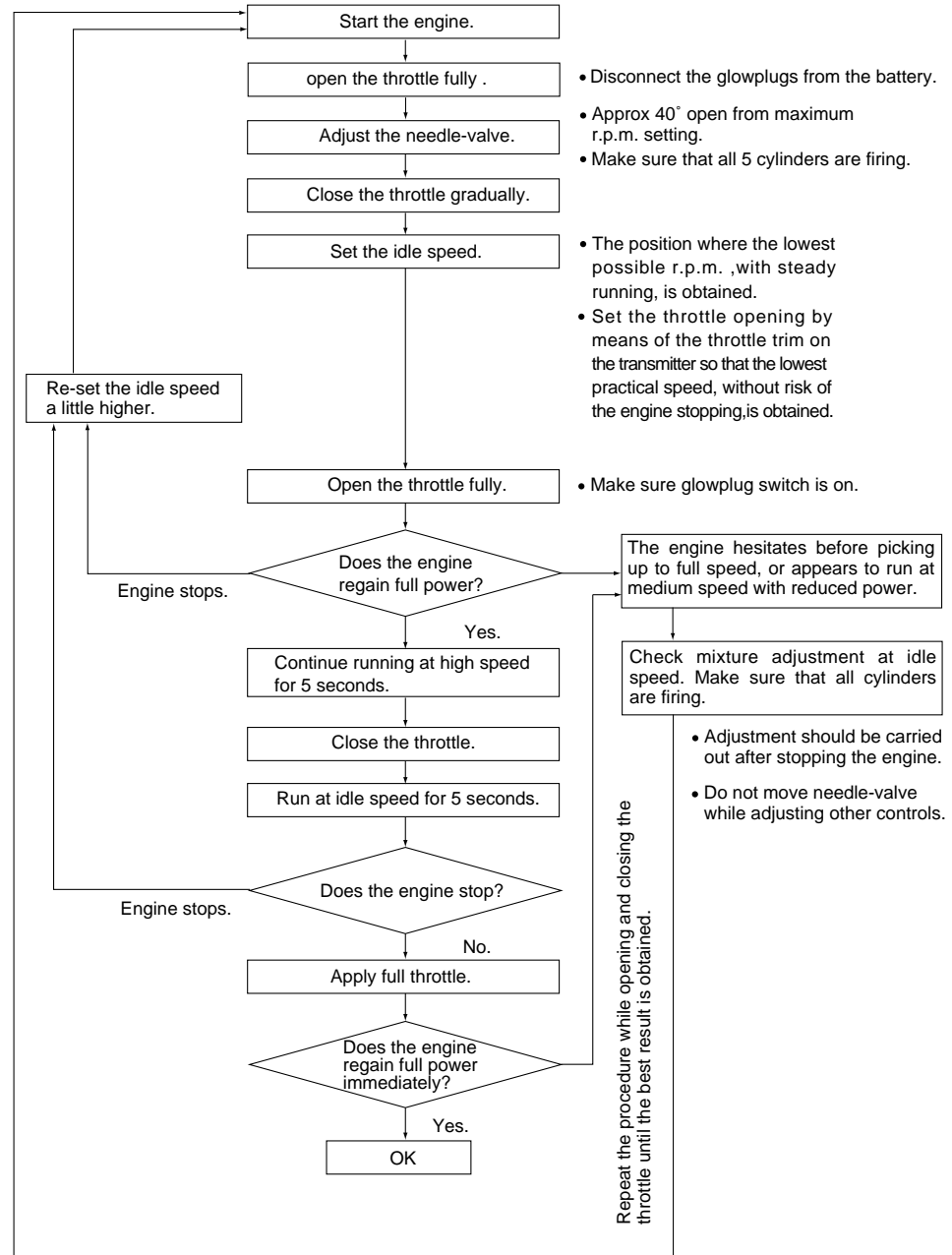

Attention: Do not leave the battery connected while adjusting the carburetor.

Adjusting the mixture control valve

1. If the engine hesitates, puffing out a good deal of smoke, before picking up to full speed, it is probable that the idle mixture is too rich.

In this case, it will be necessary to turn the Mixture Control Screw in the reverse direction from the + mark (i.e. clockwise) to lean the mixture. About 1/12 turn (30°) should be sufficient (Fig. 28).

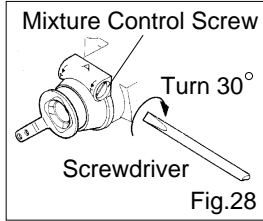

2. Alternatively, if the engine stops or is slow to pick up speed, without smoking or a strong exhaust note, it is probable that the idle mixture is too lean.

In this case, it will be necessary to turn the Mixture Control Screw in the direction of the + mark (i.e. counter-clockwise) approximately 1/12 turn (30°) (Fig. 29).

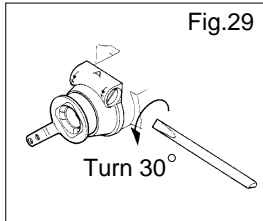

3. Thirdly, if the rpm increases but the engine appears to run with reduced power, it is probable that one of the cylinders has ceased firing. You may detect this by the difference in exhaust note and rpm compared with previous full-throttle running. The cutting out of the cylinder may be caused by the idle speed being set too low or the idle mixture being too rich.

In the case of the idling speed being too low, re-set the idle position a little higher by means of the throttle trim on the transmitter. In the case of the idle mixture being too rich, turn the Mixture Control Screw in the reverse direction

of the + mark about 1/12 turn (30°). Normal safe idle speeds are in the region of 2,000 r.p.m..

NOTE:

As this is a five-cylinder four-stroke-cycle engine, firing strokes occur every half revolution (180°), that is, two firings take place every one complete revolution. Therefore, at first you may have an impression that the engine is idling at higher r.p.m. than actual running r.p.m. It is recommended to check the engine r.p.m. with a tachometer.

Changing the make of glowplug or fuel may sometimes require re-adjustment of carburetor throttle.

Realignment of mixture control screw

In the course of making carburetor adjustments, it is just possible that the Mixture Control Screw setting may be upset. Its basic setting can be re-established as follows:

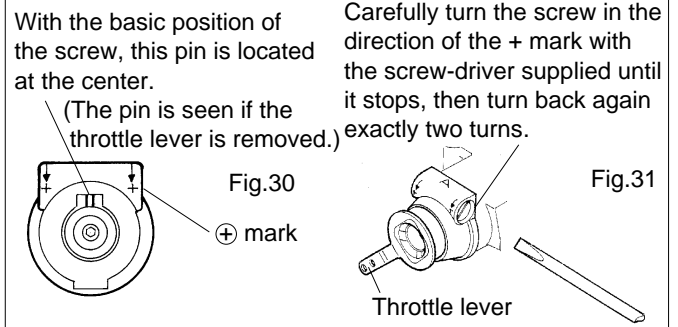

NOTE:

If an on-board glowplug re-heat system is installed, mixture adjustment at idle speed should be carried out with this in operation.

21

FLIGHT

Checking before flight

- Make sure that all five cylinders are firing.
- Make sure that engine runs steadily at idle speed.
- Make sure that engine is fully warmed up.
- It is necessary to warm up the engine as with a full-size aircraft or automobile. Do not attempt to take-off immediately after the engine has been started. Allow the engine to run at full throttle for at least 10 seconds before releasing the model.

CARE AND MAINTENANCE

To ensure that you obtain long life and peak performance from your engine, observe the following

1. Avoid running the engine under dusty conditions. If necessary, lay a sheet of plywood or hardboard in front and under the nose of the model when starting the engine.
2. Foreign matter in the fuel can cause the carburetor jet to be partially clogged.

Therefore:

- rinse out the fuel tank with methanol or fuel before installing it
- Install a fuel filter in the fuel delivery tube between tank and carburetor
- Install a fuel filter to pump inlet of the manual or electric fuel pump
- do not leave your fuel container open needlessly
- check filters periodically and clean them when necessary

3. Do not close the needle-valve to too "lean" a setting. This will cause the engine to overheat and slow down and also will generate much nitromethane oxide due to extremely high temperature which will cause internal rusting of the engine. Always adjust the needle-valve very slightly to the "rich" side of the peak r.p.m. setting.
4. Clean the exterior of the engine with a clean cotton cloth. If this is not done, oil and dirt will burn onto the outside of the engine each time it is run and the engine will soon become blackened
5. If the engine is not in use for a while (more than two months) remove the glowplugs and rinse out the interior with kerosene (not gasoline), by rotating the crankshaft. Shake out residue, then inject corrosion-inhibiting oil (preferably) or light machine-oil through the glowplug holes and breather hole, again rotating the shaft to distribute the protective oil to all working parts.

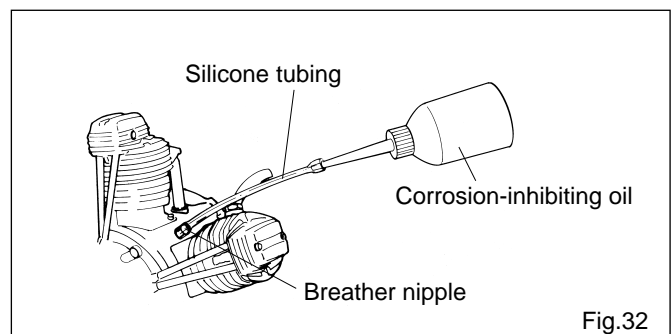

VALVE CLEARANCE ADJUSTMENT

ALL O.S. four-stroke engines have their valve (tappet) clearances correctly set before they leave the factory. However, if, after many hours of running time have been logged, a loss of power is detected, or if the engine has to be disassembled or repaired as a result of an accident, valve clearances should be checked and readjusted, as necessary, with the aid of the O.S. Valve Adjusting Tool Kit.

The kit comes in a plastic case and includes:

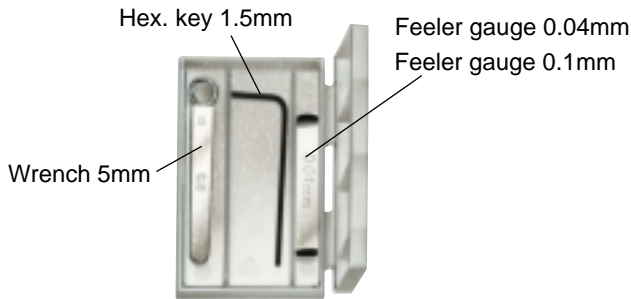

Note:
Valve clearances of all O.S. four-stroke-cycle engines must be checked and reset **ONLY WHEN THE ENGINE IS COLD**. Procedure is as follows:

(I)

1. Remove the rocker cover from each cylinder head by unscrewing two socket-head cap-screws from the rocker box on top of the cylinder head with Allen key supplied.

Note:
If the gap is found to be less than 0.04mm, it is not necessary to readjust the clearance if the engine has good compression and starts easily. Equally, if the gap exceeds 0.1mm but is not more than 0.14mm (i.e. the thickness of both feeler gauges inserted together), it is not necessary to readjust the clearance if the engine runs satisfactorily.

(II)

If a clearance is found to be outside either of these limits, it should be reset as follows.

1. Carefully loosen the locknut on rocker-arm 1/4-1/2 turn with 5mm wrench. (Fig.34.)

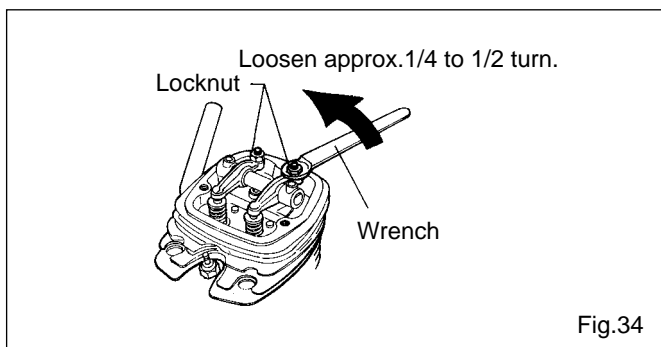

2. Remove all the glowplugs except the one installed in the cylinder that you want to check.

Note:

Each glowplug should be re-installed in the original cylinder. You may start to check and adjust with any cylinder.

3. Turn the propeller counter-clockwise until compression is first felt, then turn it further a quarter turn. At this point, both valves should be closed. (If the prop driver ('drive hub') of your engine is engraved with a letter 'T', this mark should now be at the top.)

4. The standard valve clearance, on both inlet and exhaust valves, is between 0.04mm and 0.1mm (0.0015-0.004 inch), measured between valve stem and rocker arm. Use the 0.04mm and 0.1mm feeler gauges to check clearances. (See Fig.33.)

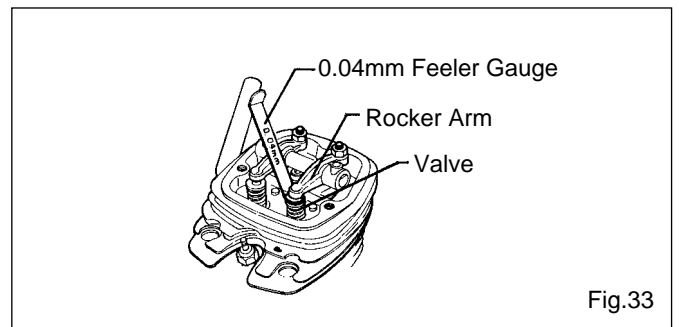

23

2. Turn adjusting-screw approx. 1/2 turn counter-clockwise to open gap, using appropriate tool-i.e. Allen hex key. (Fig.35.)

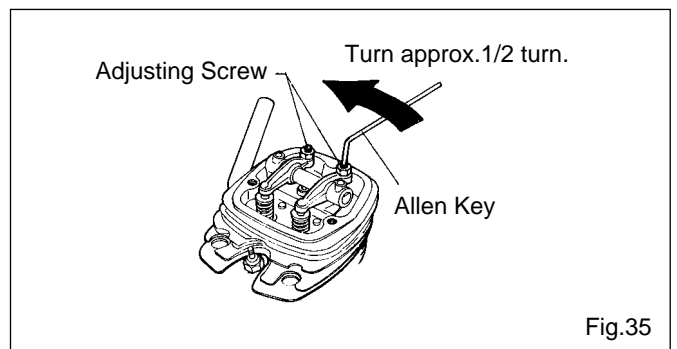

3. Insert 0.04mm feeler gauge between valve stem and rocker-arm and gently turn adjusting screw clockwise until it stops. (Fig.36.)

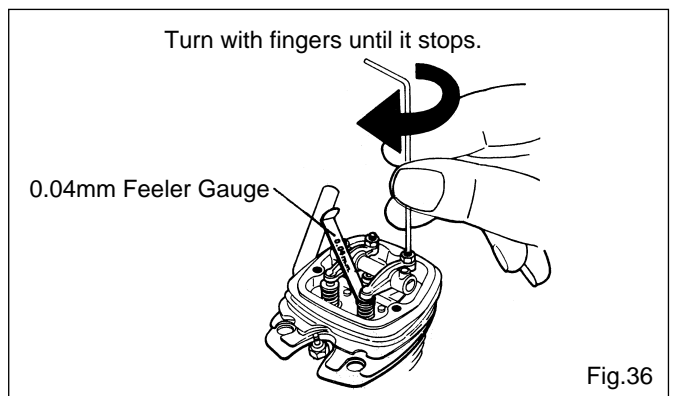

4. Re-tighten locknut while holding adjusting screw stationary.
(Fig.37.)

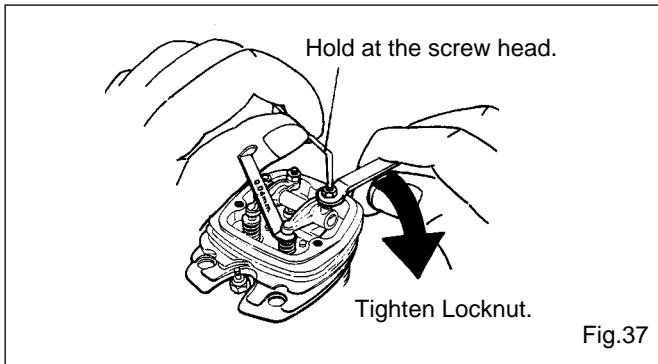

5. Remove 0.04mm feeler, rotate prop through two revolutions and recheck gap.
6. If clearance is correct, loosen the locknut on the other rocker-arm and repeat steps 1 to 5 above. Finally, replace rocker box cover.

Remember:

Excessive valve clearance will cause loss of power, due to valve (s) not opening sufficiently. On the other hand, a total loss of clearance may cause difficult starting due to valves not closing properly, resulting in loss of compression.

EXPLODED VIEW

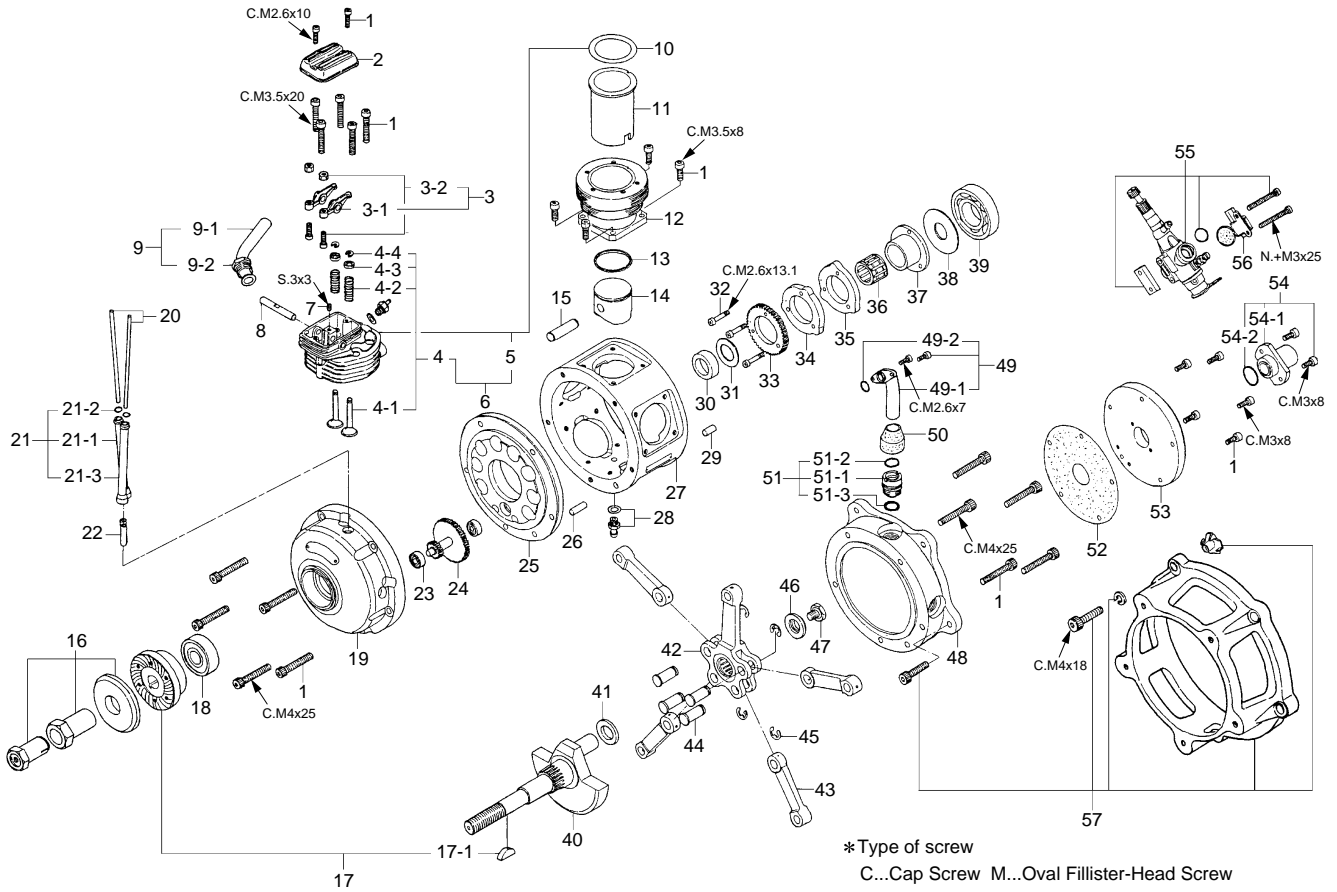

*Type of screw
 C...Cap Screw M...Oval Fillister-Head Screw
 F...Flat Head Screw N...Round Head Screw S...Set Screw

26

No.	Code No.	Description
1	47013000	Screw Set
2	45604200	Rocker Cover
3	45361000	Rocker Arm Assembly (1pair)
3-1	45361100	Rocker Arm (1pc.)
3-2	45061202	Tappet Adjusting Screw
4	46360010	Valve Assembly (1pair)
4-1	46160100	Valve (1pc.)
4-2	45060205	Valve Spring (1pc.)
4-3	45060309	Valve Spring Seat (1pc.)
4-4	46160400	Valve Spring Retainer (2pcs.)
5	47004100	Cylinder Head
6	47004010	Cylinder Head (W/Valve Assembly)
7	26381501	Rocker Shaft Set Screw
8	45661500	Rocker Shaft
9	45269000	Exhaust Pipe Assembly (1pair)
9-1	45269100	Exhaust Pipe
9-2	45069200	Exhaust Pipe Lock Nut
10	47014000	Head Gasket (5pcs.)
11	47003100	Cylinder Liner
12	47003300	Cylinder Jacket
13	26603400	Piston Ring
14	45603200	Piston
15	45606000	Piston Pin
16	46210100	Propeller Locnut Set (L)
17	47008000	Drive Hub
17-1	29208200	Woodruff Key
18	29031009	Crankshaft Bearing (Front)
19	47001600	Front Housing
20	47066000	Push Rod Set (S&L 1Piece Each)
21	47066100	Push Rod Cover Set (S&L 1Piece Each)
21-1	47066110	Push Rod Cover (S)
21-2	47066120	Push Rod Cover (L)
21-3	24881824	Push Rod Cover "O" Ring (2pcs.)
22	47064000	Cam Follower (2pcs.)
23	47031000	Reduction Gear Bearing
24	47062700	Reduction Gear
25	47001610	Front Plate
26	47001100	Pin for Crankcase and front plate alignment
27	47001000	Crankcase
28	24025923	Drain Nipple (No.2)
29	47001810	Pin for crankcase and back plate alignment

No.	Code No.	Description
30	47002100	Crankshaft Spacer
31	47062300	Cam Thrust Washer (B)
32	47062600	Cam Assembly Screw (3pcs.)
33	47062500	Cam Gear
34	47062000	Intake Cam
35	47062100	Exhaust Cam
36	47030000	Cam Holder Bearing
37	47062400	Cam Holder
38	47062200	Cam Thrust Washer (A)
39	29030001	Crankshaft Bearing (Rear)
40	47002000	Crankshaft
41	47002300	Master Con-rod Spacer
42	47005000	Master Connecting Rod
43	47005300	Link Rod
44	47005400	Link Pin
45	47005500	Link Pin Retainer (4pcs.)
46	47002200	Crank Pin Washer
47	46202300	Master Con-rod Retaining Screw
48	47001800	Back Plate
49	47068200	Intake Pipe Assembly (1pair)
49-1	47068210	Intake Pipe
49-2	21015001	Intake Pipe "O" Ring
50	46168500	Intake Boots (2pcs.)
51	47068100	Intake Pipe Holder Assembly
51-1	47068110	Intake Pipe Holder
51-2	45115000	"O" Ring (L)
51-3	21015001	"O" Ring (S)
52	47014300	Cover Gasket
53	47007000	Cover Plate
54	47068000	Intake Manifold Assembly
54-1	47068010	Intake Manifold
54-2	22615000	Intake Manifold "O" Ring
55	47081000	Carburetor Complete
56	45484000	Choke Valve
57	71912000	Radial Motor Mount Assembly
	71615009	Glow Plug Type F
	72200120	Booster Cable Set
	72200060	Valve Adjusting Kit
	46471000	Drain Plug
	72600010	Display Stand

The specifications are subject to alteration for improvement without notice.

CARBURETOR EXPLODED VIEWS & PARTS LIST

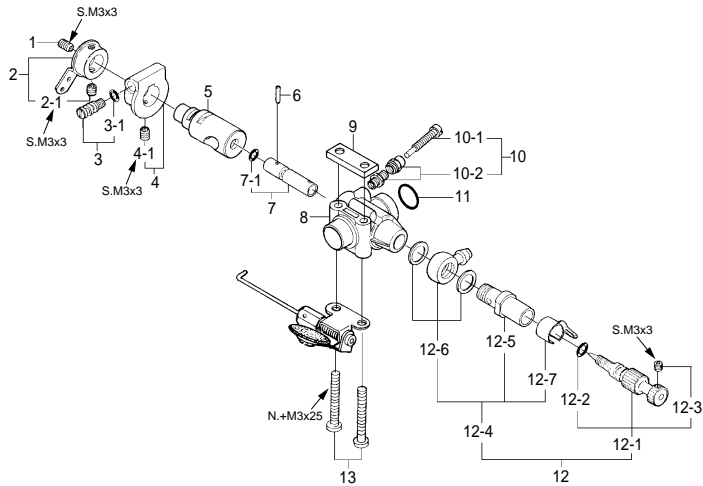

Note: The choke valve assembly is not included in the carburettor complete.

* Type of screw

C...Cap Screw M...Oval Fillister-Head Screw
 F...Flat Head Screw N...Round Head Screw S...Set Screw

No.	Code No.	Description
1	26381501	Set-screw
2	24981405	Throttle Lever Assembly
2-1	26381501	Set-screw
3	46481320	Mixture Control Screw Assembly
3-1	22781800	"O" Ring (2pcs.)
4	46481330	Mixture Control Screw Holder Assembly
4-1	26381501	Set-screw
5	46481200	Carburetor Rotor
6	46281340	Mixture Control Valve Pin
7	46481310	Mixture Control Valve Assembly
7-1	22781800	"O" Ring (2pcs.)
8	46481100	Carburetor Body
9	46281900	Needle Valve Assembly
9-1	29081952	Needle Assembly
9-2	24981837	"O" Ring (2pcs.)
9-3	26381501	Set-screw
9-4	46181940	Needle Valve Holder Assembly
9-5	46181941	Needle Valve Holder
9-6	46181950	Fuel Inlet
9-7	26711305	Ratchet Spring
10	26781619	Throttle Stop Screw Assembly
10-1	26681305	Throttle Stop Screw
10-2	26681803	Throttle Stop Screw Holder
11	45581700	Carburetor Retaining Screw

The specifications are subject to alteration for improvement without notice.

ASSEMBLY OF FR5-300 (SIRIUS) DISPLAY STAND

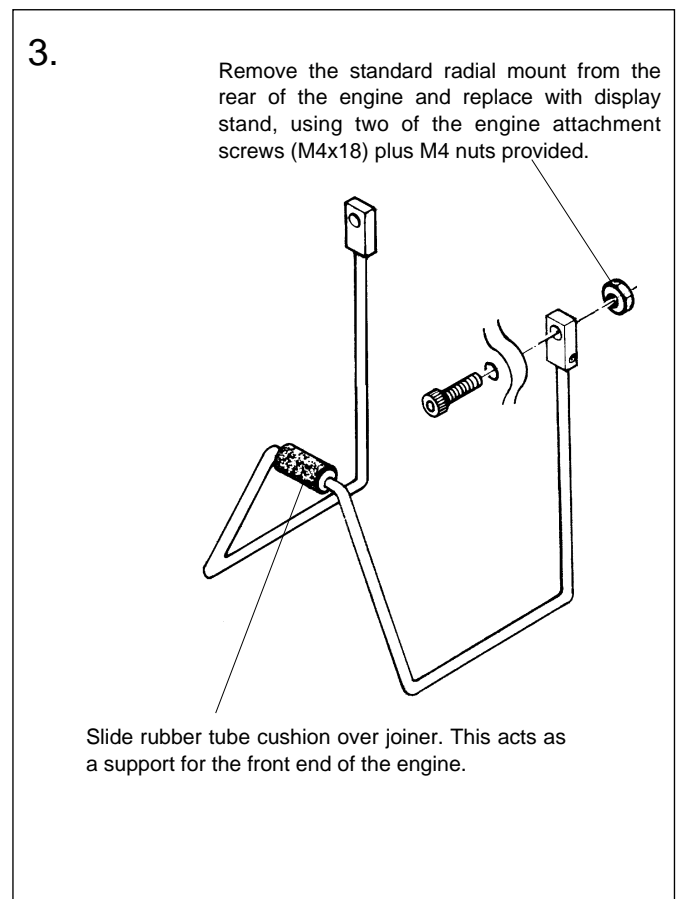
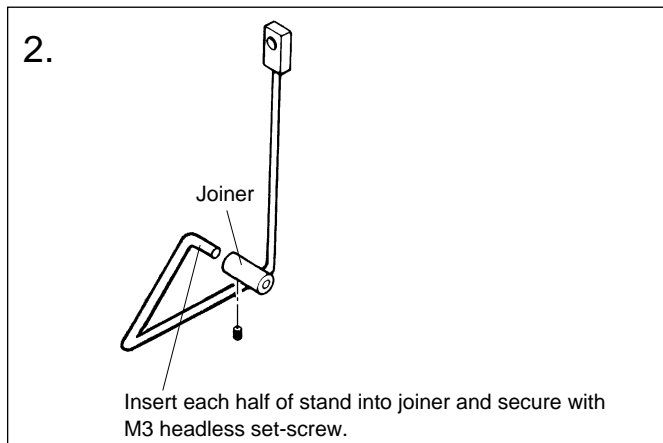
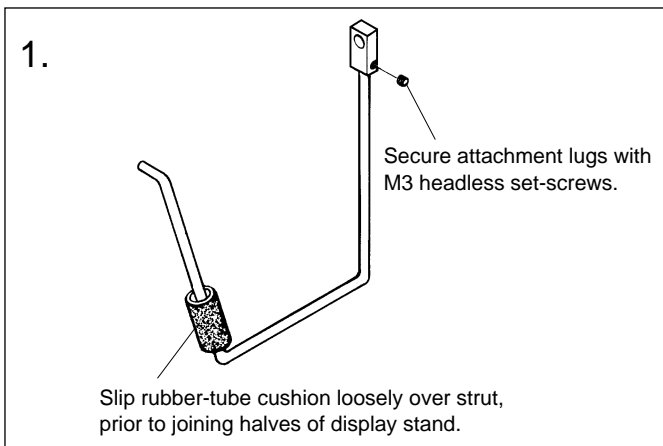

O.S. GENUINE PARTS & ACCESSORIES

■ O.S.GLOW PLUG TYPE F
(71615009)

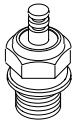

■ 3/8"-M5 (L) PROPELLER LOCKNUT SET FOR 4C SPINNER
(46210300)



■ NON-BUBBLE WEIGHT
(71531000)



■ SUPER FILTER (L)
(72403050)

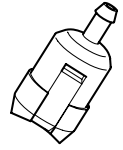

■ EXHAUST COLLECTOR RING

Front (47069000)



Rear (47069010)



■ BLIND NUT (10pcs.)

M5
(79870050)



■ LOCK WASHER (10sets)

M5
(55500004)

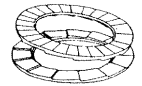

■ FLEXIBLE EXHAUST PIPE



Code.No.	Type	Length (mm)
72108000	1011A	120
72108010	1011B	240

■ CAP SCREW SET (10pcs.)

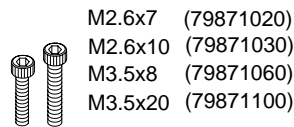

M2.6x7 (79871020)
M2.6x10 (79871030)
M3.5x8 (79871060)
M3.5x20 (79871100)

■ LONG SOCKET WRENCH WITH PLUG GRIP
(71521000)

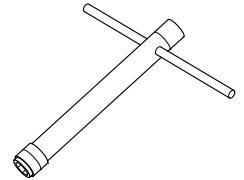

The specifications are subject to alteration for improvement without notice.

THREE VIEW DRAWING

Specifications

■ Displacement	9.95 cc x 5 / 0.607cu.in. x 5
■ Bore	24.0 mm / 0.945 in.
■ Stroke	22.0 mm / 0.866 in.
■ Practical R.P.M.	1,800-8,500 r.p.m.
■ Output	
■ Weight	2,670 g / 94.3 oz.

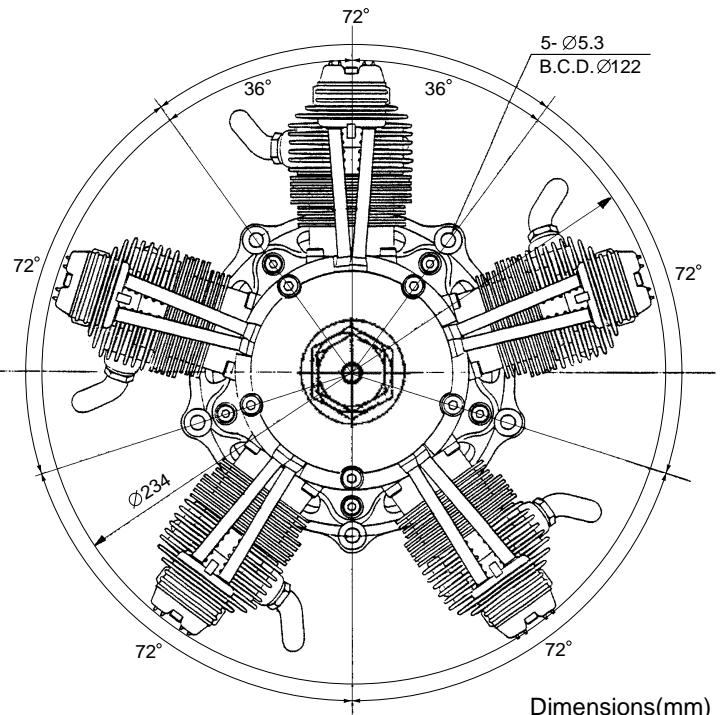
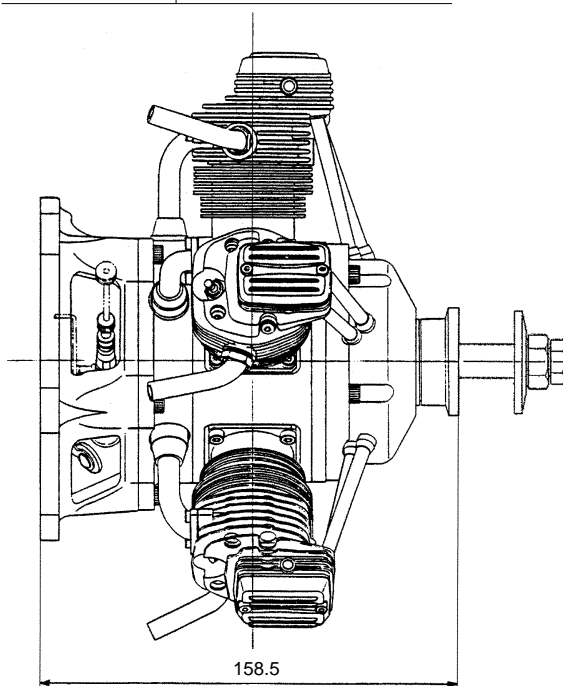

MEMO

.....

.....

.....

.....

.....

.....

.....

.....

.....

.....



O.S. ENGINES MFG. CO., LTD.

6-15 3-Chome Imagawa Higashisumiyoshi-ku
Osaka 546-0003, Japan TEL. (06) 6702-0225

FAX. (06) 6704-2722

URL : <http://www.os-engines.co.jp>