

MODEL 7105



1/16

E-REVO

TRAXXAS

OWNER'S MANUAL

INTRODUCTION

- 3 BEFORE YOU PROCEED
- 4 SAFETY PRECAUTIONS
- 5 TOOLS, SUPPLIES AND REQUIRED EQUIPMENT
- 6 ANATOMY OF THE MODEL
- 7 QUICK START: GETTING UP TO SPEED
- 8 THE TRAXXAS TQ RADIO SYSTEM
- 14 ADJUSTING THE ELECTRONIC SPEED CONTROL
- 16 DRIVING YOUR MODEL
- 19 TUNING ADJUSTMENTS
- 23 MAINTAINING YOUR MODEL

Thank you for purchasing a Traxxas 1/16 scale model. Your new model combines proven Traxxas innovations including F1-inspired, rocker-actuated suspension, waterproof electronics, and a monocoque-style chassis for outstanding handling and incredible speed and power. Your Traxxas model is designed for high-performance driving, with balanced weight distribution, lightweight and high-strength materials, and the precise engineering that is the hallmark of all Traxxas vehicles.

This manual contains the instructions you will need to operate and maintain your model so that you can enjoy it for years to come. We want you to feel confident that you own one of the best-performing models in the market and that it is backed by a team of professionals who aim to provide the highest level of factory support possible. Traxxas models are about experiencing total performance and satisfaction, not just with your model, but also with the company that stands behind it.

We know you're excited about getting your new model on the road or trail, but it's very important that you take some time to read through the Owner's Manual. This manual contains all the necessary setup and operating procedures that allow you to unlock the performance and potential that Traxxas engineers designed into your model. **Even if you are an experienced R/C enthusiast, it's important to read and follow the procedures in this manual.**

Thank you again for going with Traxxas. We work hard every day to assure you the highest level of customer satisfaction possible. We truly want you to enjoy your new model!

Traxxas Support

Traxxas support is with you every step of the way. Refer to the next page to find out how to contact us and what your support options are.



Quick Start

This manual is designed with a Quick Start path that outlines the necessary procedures to get your model up and running in the shortest time possible. If you are an experienced R/C enthusiast you will find it helpful and fast. Be sure and read through the rest of the manual to learn about important safety, maintenance, and adjustment procedures. Turn to page 7 to begin.



BEFORE YOU PROCEED

Carefully read and follow all instructions in this and any accompanying materials to prevent serious damage to your model. Failure to follow these instructions will be considered abuse and/or neglect.

Before running your model, look over this entire manual and examine the model carefully. If for some reason you decide it is not what you wanted, then do not continue any further. **Your hobby dealer absolutely cannot accept a model for return or exchange after it has been run.**

WARNINGS, HELPFUL HINTS, & CROSS-REFERENCES

Throughout this manual, you'll notice warnings and helpful hints identified by the icons below. Be sure to read them!



An important warning about personal safety or avoiding damage to your model and related components.



Special advice from Traxxas to make things easier and more fun.



Refers you to a page with a related topic.

SUPPORT

If you have any questions about your model or its operation, call the Traxxas Technical Support line toll-free at: **1-888-TRAXXAS (1-888-872-9927)***

Technical support is available Monday through Friday from 8:30am to 9:00pm central time. Technical assistance is also available at Traxxas.com. You may also e-mail customer support with your question at support@Traxxas.com. Join thousands of registered members in our online community at Traxxas.com.

Traxxas offers a full-service, on-site repair facility to handle any of your Traxxas service needs. Maintenance and replacement parts may be purchased directly from Traxxas by phone or online at BuyTraxxas.com. You can save time, along with shipping and handling costs, by purchasing replacement parts from your local dealer.

Do not hesitate to contact us with any of your product support needs. We want you to be thoroughly satisfied with your new model!

Traxxas
1100 Klein Road
Plano, Texas 75074
Phone: 972-265-8000
Toll-free 1-888-TRAXXAS

Internet
Traxxas.com
E-mail: support@Traxxas.com

Entire contents ©2011 Traxxas. Traxxas, Ready-To-Race, Ready-To-Win, Titan, and ProGraphix are trademarks or registered trademarks of Traxxas. Other brand names and marks are the property of their respective holders and are used only for purposes of identification. No part of this manual may be reproduced or distributed in print or electronic media without the express written permission of Traxxas. Specifications are subject to change without notice.

SAFETY PRECAUTIONS



All instructions and precautions outlined in this manual should be strictly followed to ensure safe operation of your model.



This model is not intended for use by children under 14 years of age without the supervision of a responsible and knowledgeable adult.



No previous experience with radio controlled models is required. Models require a minimum of setup, maintenance, or support equipment.



All of us at Traxxas want you to safely enjoy your new model. Operate your model sensibly and with care, and it will be exciting, safe, and fun for you and those around you. Failure to operate your model in a safe and responsible manner may result in property damage and serious injury. The precautions outlined in this manual should be strictly followed to help ensure safe operation. You alone must see that the instructions are followed and the precautions are adhered to.

IMPORTANT POINTS TO REMEMBER

- ⊕ Your model is not intended for use on public roads or congested areas where its operation can conflict with or disrupt pedestrian or vehicular traffic.
- ⊕ Never, under any circumstances, operate the model in crowds of people. Your model is very fast and could cause injury if allowed to collide with anyone.
- ⊕ Because your model is controlled by radio, it is subject to radio interference from many sources that are beyond your control. Since radio interference can cause momentary losses of radio control, always allow a safety margin in all directions around the model in order to prevent collisions.
- ⊕ The motor, battery, and speed control can become hot during use. Be careful to avoid getting burned.
- ⊕ Don't operate your model at night, or anytime your line of sight to the model may be obstructed or impaired in any way.
- ⊕ **Most importantly, use good common sense at all times.**

BATTERIES AND BATTERY CHARGING

Your model uses rechargeable batteries that must be handled with care for safety and long battery life. Make sure to read and follow all instructions and precautions that were provided with the battery packs and your charger. It is your responsibility to charge and care for the battery packs properly. In addition to your battery and charger instructions, here are some more tips to keep in mind.

- ⊕ Use the supplied charger to charge the included battery. See "Charging the Battery Pack" on page 10.
- ⊕ Never leave batteries to charge unattended.
- ⊕ Remove the battery from the model while charging.
- ⊕ Always unplug the battery from the electronic speed control when the model is not in use and when it is being stored or transported.
- ⊕ Allow the battery pack to cool off between runs (before charging).
- ⊕ Do not use battery packs that have been damaged in any way.

- ⊕ Do not use battery packs that have damaged wiring, exposed wiring, or a damaged connector.
- ⊕ Children should have responsible adult supervision when charging and handling batteries.

Recycling Your Traxxas Power Cell NiMH Battery

Traxxas strongly encourages you to recycle your Power Cell battery when it has reached the end of its useful life. **Do not throw your battery in the trash.** All Power Cell battery packs display the RBRC (Rechargeable Battery Recycling Corporation) icon, indicating they are recyclable. To find a recycling center near you, ask your local hobby dealer or visit www.call2recycle.org.

SPEED CONTROL

- ⊕ **Disconnect the Battery:** Always disconnect the battery from the speed control when not in use.
- ⊕ **Transmitter on First:** Switch on your transmitter first before switching on the speed control to prevent runaways and erratic performance.
- ⊕ **Don't Get Burned:** The heat sink can get extremely hot, so be careful not to touch it until it is cool. Supply adequate airflow for cooling.
- ⊕ **Use Stock Connectors:** If you decide to change the battery or motor connectors, only change one battery or motor connector at a time. This will prevent damage from accidentally mis-wiring the speed control. Please note that modified speed controls can be subject to a rewiring fee when returned for service. Removing the battery connector on the speed control or using connectors with no reverse-polarity protection on the speed control will void the product's warranty.
- ⊕ **Insulate the Wires:** Always insulate exposed or damaged wiring with heat shrink tubing to prevent short circuits.
- ⊕ **No Reverse Voltage:** The speed control is not protected against reverse polarity voltage. When changing the battery and/or motor, be sure to install the same type of connectors to avoid reverse polarity damage to the speed control. Removing the battery connectors on the speed control or using the same-gender connectors on the speed control will void the product's warranty.
- ⊕ **No Schottky Diodes:** External Schottky diodes are not compatible with reversing speed controls. Using a Schottky diode will damage the electronic speed control and void the 30-day warranty.
- ⊕ **Using Two Batteries:** When using two batteries the batteries must be connected in parallel. Never connect two batteries in series, this will cause the ESC to fail. See page 11 for more information.

TOOLS, SUPPLIES AND REQUIRED EQUIPMENT

Your model comes with a set of specialty metric tools. You'll need to purchase other items, available from your hobby dealer, to operate and maintain your model.

SUPPLIED TOOLS AND EQUIPMENT



1.5mm "L" wrench



2.0mm "T" wrench



2.5mm ball driver wrench

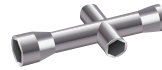

4-way wrench



6-cell 2/3A NiMH battery

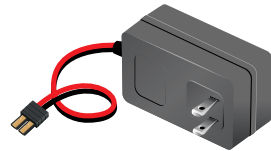

NiMH battery charger



Body clips

WARNING: Lithium Polymer (LiPo) packs should not be used with the XL-2.5 speed control. The XL-2.5 speed control is not equipped with low-voltage detection.

REQUIRED EQUIPMENT (SOLD SEPARATELY)



8 AA alkaline
batteries



For more information on batteries, see *Use the Right Batteries* on page 11.



Recommended Equipment
These items are not required for the operation of your model, but are a good idea to include in any R/C toolbox:

- Safety glasses
- Thin, hobby-quality cyanoacrylate instant tire glue (CA glue)
- Hobby knife
- Side cutters and/or needle nose pliers
- Philips screwdriver
- Soldering iron

DECORATING YOUR MODEL

APPLYING THE DECALS

The main decals for your model have been applied at the factory. The decals are printed on self-adhesive clear mylar and are die-cut for easy removal. Use a hobby knife to lift the corner of a decal and lift it from the backing. To apply the decals, place one end down, hold the other end up, and gradually smooth the decal down with your finger as you go. This will prevent air bubbles. Placing both ends of the decal down and then trying to smooth it out will result in air pockets.

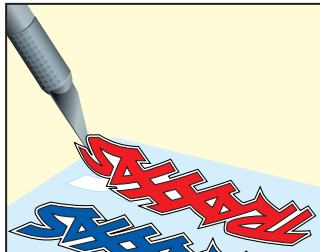

Look at the photos on the box for typical decal placement.

TIRE GLUING

The factory tires on your model are already glued to the rims. The tires must be glued to the rims to prevent the rims from spinning inside the tires. The instructions here are provided to show you how to glue replacement tires to the rims in the future. Use CA tire glue available from your local hobby dealer. You can glue the tires without removing the wheels from the model. For clarity, these instructions show the process with the wheels removed.

1. Remove a wheel from the model using the larger (7mm) end of the universal wrench.
2. Use your thumb to push the side of the tire away from the rim. Place one or two drops of CA glue into the opening and release the tire. Capillary action will draw the glue around the bead of the tire.
3. Repeat step two at four or five points around the rim, until the tire is completely secured to the rim. Turn the rim over and repeat the process for the inside of the rim/tire. Repeat for the other three wheels.
4. Reinstall the wheels, make sure none of the axle pins have fallen out from behind the hex hubs.



ANATOMY OF THE MODEL

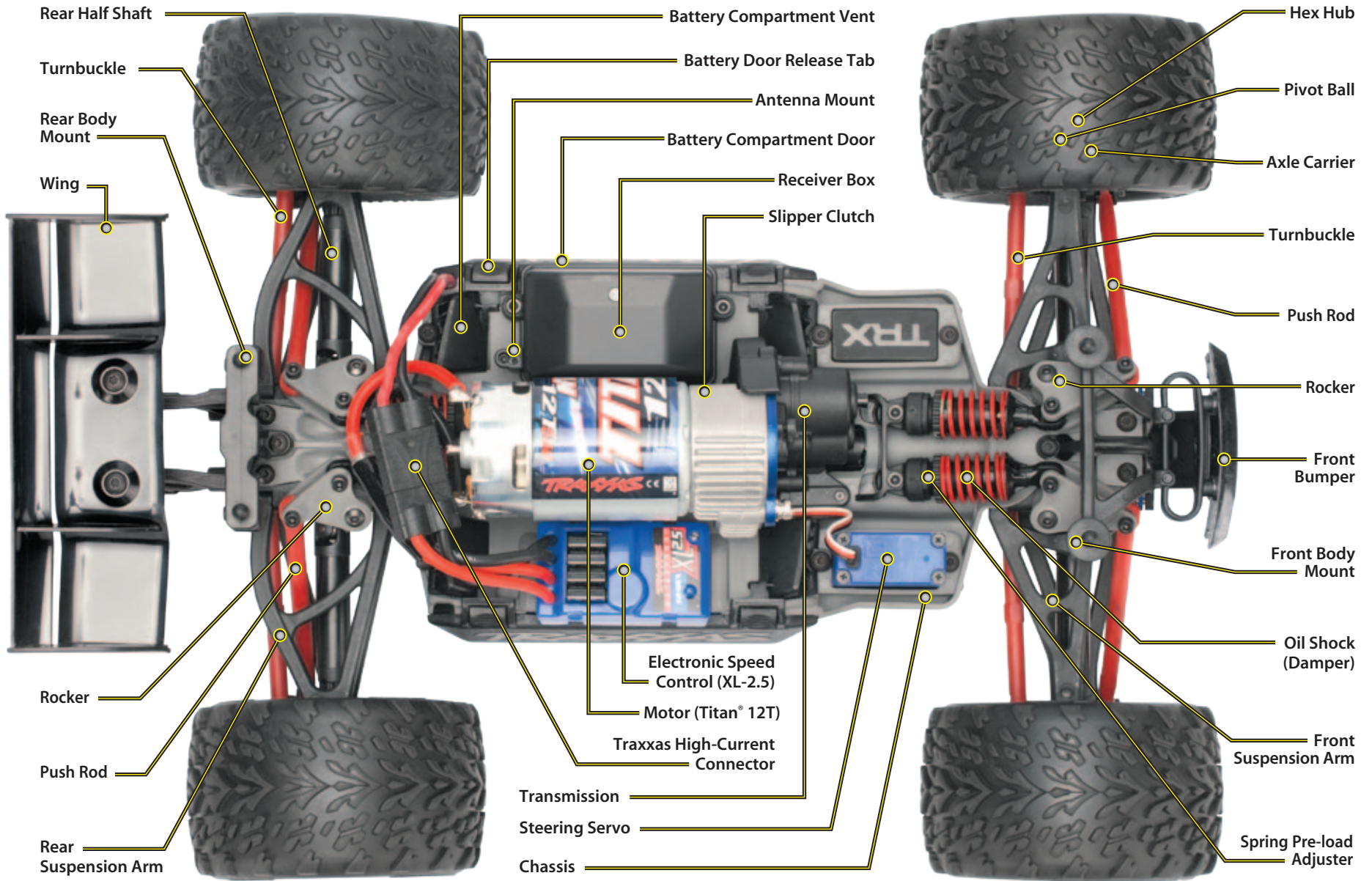

QUICK START: GETTING UP TO SPEED

 The following guide is an overview of the procedures for getting your model running. Look for the Quick Start logo on the bottom corners of Quick Start pages.

1. Read the safety precautions on page 4

For your own safety, understand where carelessness and misuse could lead to personal injury.

7. Check servo operation • See page 13

Make sure the steering servo is working correctly.

2. Charge the battery pack • See page 10

Fully charge the battery pack included with your model.

8. Range test the radio system • See page 13

Follow this procedure to make sure your radio system works properly at a distance and that there is no interference from outside sources.

3. Install the antenna • See page 10

Install the antenna mast in the model.

9. Detail your model • See page 5

Apply other decals if desired.

4. Install batteries in the transmitter • See page 10

The transmitter requires 8 AA alkaline or rechargeable batteries.

10. Drive your model • See page 16

Driving tips and adjustments for your model.

5. Install the battery pack • See page 11

Install the included battery pack in your model.

11. Maintaining your model • See page 23

Follow these critical steps to maintain the performance of your model and keep it in excellent running condition.

6. Turn on the radio system • See page 13

Make a habit of turning the transmitter on first, and off last.



The Quick Start Guide is not intended to replace the full operating instructions available in this manual. Please read this entire manual for complete instructions on the proper use and maintenance of your model.

Look for the Quick Start logo at the bottom of Quick Start pages.



THE TRAXXAS TQ RADIO SYSTEM

XL-2.5 Wiring Diagram

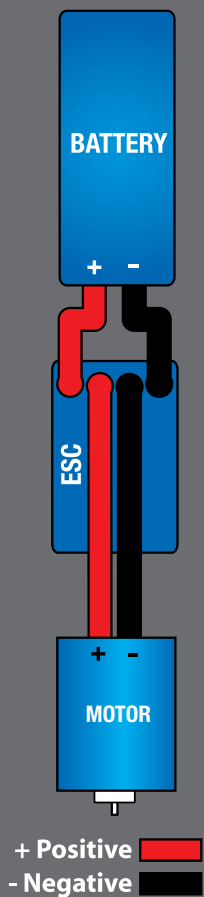

Your model is equipped with the Traxxas TQ Radio System is a 2-channel system that provides high-power output up to a quarter mile. Your model uses one steering servo and an electronic speed control. The receiver is equipped with four channels and dual channel 1 outputs.

TQ TRANSMITTER

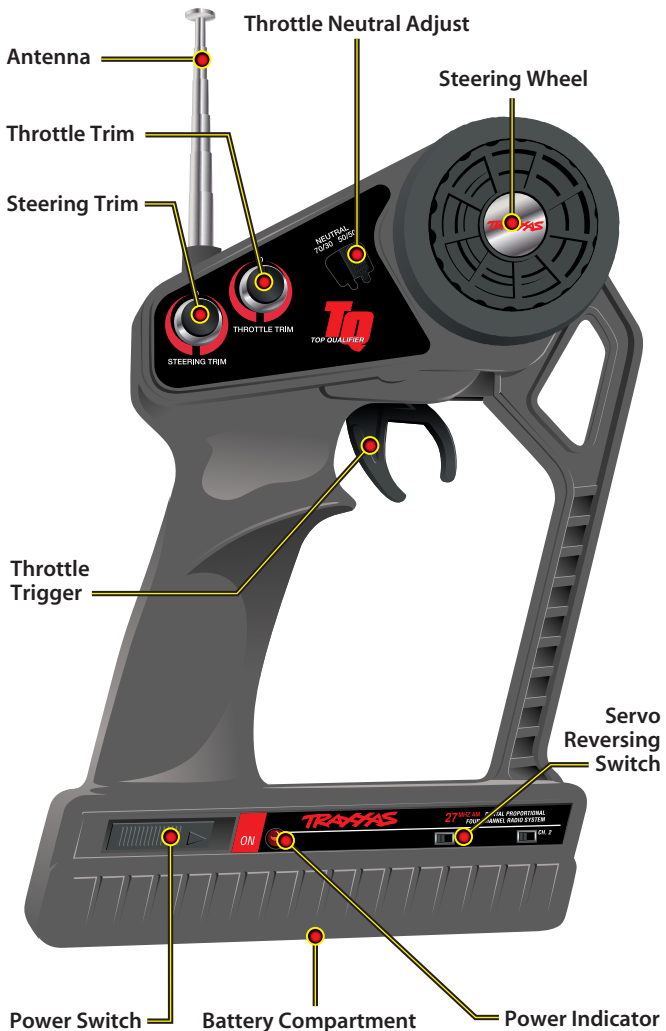

RADIO SYSTEM WIRING DIAGRAM

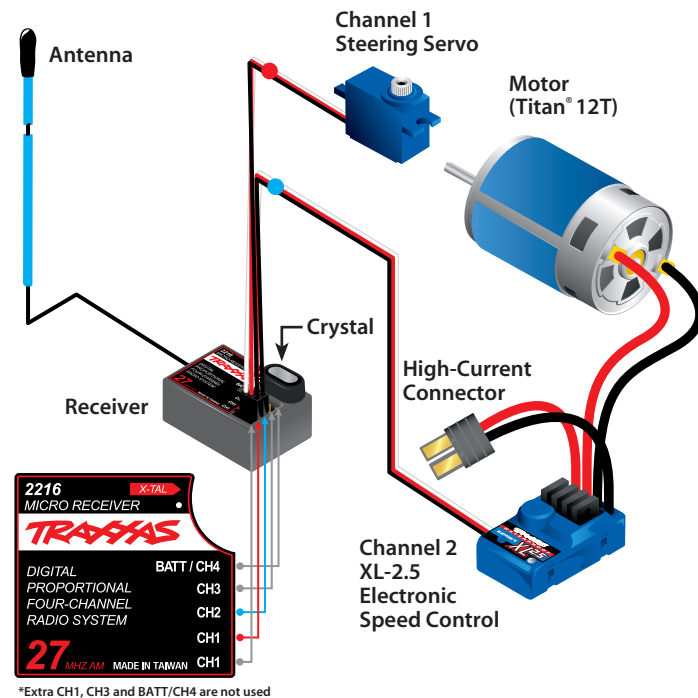

XL-2.5 ELECTRONIC SPEED CONTROL

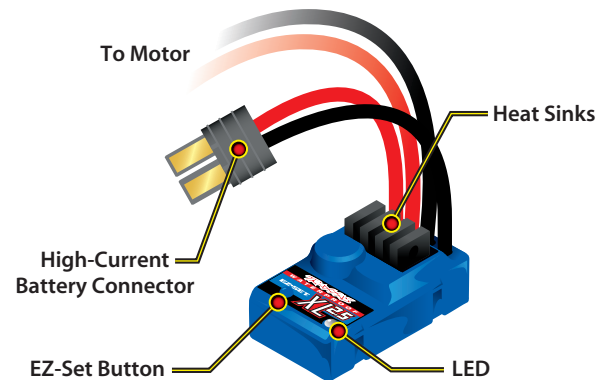







RADIO SYSTEM TERMINOLOGY

Please take a moment to familiarize yourself with these radio and power system terms. They will be used throughout this manual.

BEC (Battery Eliminator Circuit) - The BEC can either be in the receiver or in the ESC. This circuit allows the receiver and servos to be powered by the main battery pack in an electric model. This eliminates the need to carry a separate pack of 4 AA batteries to power the radio equipment.

Channel - The 27 MHz frequency band is divided into 6 channels so that up to six models can be operated simultaneously. Each channel is referred to by its flag color and channel number, as shown on the chart to the right.

CHANNEL	FREQUENCY BAND	FLAG COLOR	TRAXXAS PART NO.
 1	26.995	BROWN	2031
 2	27.045	RED	2032
 3	27.095	ORANGE	2033
 4	27.145	YELLOW	2034
 5	27.195	GREEN	2035
 6	27.255	BLUE	2036

Clearing your frequency - A routine, verbal check to make sure nobody else in your area is operating on the same channel. Always clear your frequency by calling out your channel number before operating your model. Wait or move to another area if your channel is already being used.

Crystal (X-tal) - The plug-in device that determines which channel the radio system will operate on. For each channel, there are two crystals, one for the receiver and one for the transmitter. Of those two crystals, the one marked with the lower number (.455 MHz lower) must be inserted into the receiver.

Current - Current is a measure of power flow through the electronics, usually measured in amps. If you look at wire like a garden hose, current is a measure of how much water is flowing through the hose.

ESC (Electronic Speed Control) - An electronic speed control is the electronic motor control inside the model. Electronic speed controls use power more efficiently than mechanical speed controls so that the battery runs longer. An electronic speed control also has circuitry that prevents loss of steering and throttle control as the battery loses its charge.

Frequency band - The radio frequency used by the transmitter to send signals to your model. All Traxxas RTR models operate on a 27 MHz frequency band.

kV Rating - Brushless motors are often rated by their kV number. The kV rating equals no-load motor rpm with 1 volt applied. The kV increases as the number of wire turns in the motor decreases. As the kV increases, the current draw through the electronics also increases.

mAh - Abbreviation for milliamp hour. A measure of the capacity of the battery pack. The higher the number, the longer the battery will last between recharges.

Neutral position - The standing position that the servos seek when the transmitter controls are at the neutral setting.

NiCad - Abbreviation for nickel-cadmium. The original rechargeable hobby pack, NiCad batteries have very high current handling, high capacity, and can last up to 1000 charging cycles. Good charging procedures are required to reduce the possibility of developing a "memory" effect and shortened run times.

NiMH - Abbreviation for nickel-metal hydride. Rechargeable NiMH batteries offer high current handling, and much greater resistance to the "memory" effect. NiMH batteries generally allow higher capacity than NiCad batteries. They can last up to 500 charge cycles. A peak charger designed for NiMH batteries is required for optimal performance.

Receiver - The radio unit inside your model that receives signals from the transmitter and relays them to the servos.

Resistance - In an electrical sense, resistance is a measure of how an object resists or obstructs the flow of current through it. When flow is constricted, energy is converted to heat and is lost. Traxxas power systems are optimized to reduce electrical resistance and the resulting power-robbing heat.

Servo - Small motor unit in your model that operates the steering mechanism.

Transmitter - The hand-held radio unit that sends throttle and steering instructions to your model.

Trim - The fine-tuning adjustment of the neutral position of the servos, made by adjusting the throttle and steering trim sliders on the face of the transmitter.

Thermal Shutdown Protection - Temperature sensing electronics used in the electronic speed control detect overloading and overheating of the transistor circuitry. If excessive temperature is detected, the unit automatically shuts down to prevent damage to the electronics.

2-channel radio system - The TQ radio system, consisting of the receiver, the transmitter, and the servos. The system uses two channels: one to operate the throttle and one to operate the steering.

Voltage - Voltage is a measure of the electrical potential difference between two points, such as between the positive battery terminal and ground. Using the analogy of the garden hose, while current is the quantity of water flow in the hose, voltage corresponds to the pressure that is forcing the water through the hose.



If the power indicator doesn't light red, check the polarity of the batteries. Check rechargeable batteries for a full charge.



Spray a little window cleaner on the antenna wire to make it easier to push through the antenna tube.



If there are any kinks in the black antenna wire, it will be more difficult to push through the antenna tube. Pull the wire straight by sandwiching it between your thumb and index finger and running your fingers along the length of the wire (with medium pressure).



Don't shorten the length of the antenna wire. Its length is tuned to the frequency band; cutting it could severely shorten the radio system's range.



See page 18 for more information about the receiver box and maintaining a watertight seal.

Q5
2,3,4

INSTALLING TRANSMITTER BATTERIES

Your TQ transmitter uses 8 AA batteries (see sidebar, page 11). The battery compartment is located in the base of the transmitter.

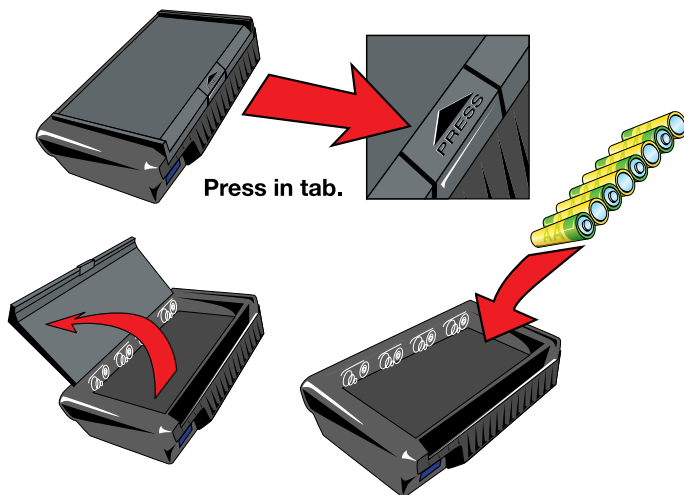

1. Remove the battery compartment door by pressing the tab and lifting the door up.
2. Install the batteries in the correct orientation as indicated in the battery compartment.
3. Reinstall the battery door and snap it closed.
4. Turn on the transmitter and check the power indicator for a solid red light.

If the power indicator light flashes, then the transmitter batteries are weak, discharged or possibly installed incorrectly. Replace with new or freshly charged batteries. The power indicator light does not indicate the charge level of the battery pack installed in the model.



SETTING UP THE ANTENNA

1. Locate the black antenna wire that exits the receiver box.
2. Pull the wire straight with your fingers and then insert the end of the wire into one end of the antenna tube (the antenna tube can be found in the documents bag). Push the wire all the way through the antenna tube. The wire is longer than the tube. Do not cut or shorten the antenna wire.
3. Insert the base of the tube into the antenna mount. Take care not to crimp the antenna wire.
4. Using the supplied 1.5mm "L" wrench, thread the 1.5mm set screw into the opening next to the antenna. Tighten the set screw until it is flush with the top of the opening.
5. Fold the top of the antenna wire over the top of the antenna tube. Slide the antenna tip onto the top of the antenna tube. Do not cut or shorten the antenna wire.
6. The receiver antenna installation is complete. Always fully extend the transmitter's telescoping antenna when running your model. Make a habit of holding the transmitter so the antenna points straight up.

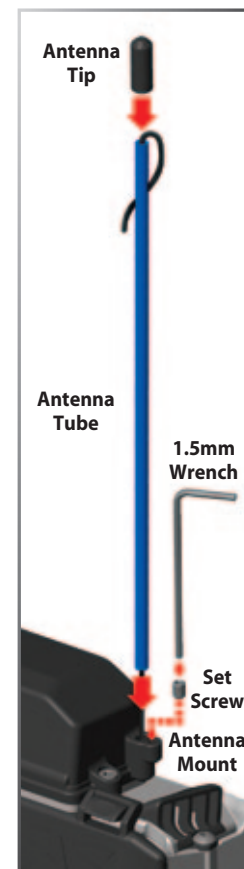

CHARGING THE BATTERY PACK

Your model includes a 'wall charger' that will charge the supplied battery in approximately six hours. Plug the charger into the wall. Connect the included battery pack to the charger output cord. After six hours, unplug the battery from the charger, and unplug the charger from the wall, when charging is complete. Never leave a battery unattended while charging.

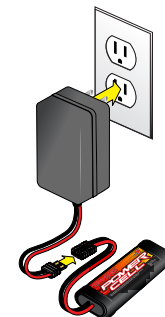

INSTALLING BATTERY PACK

Your model includes a 7.2-volt battery pack. To properly balance the model, it should be installed in the battery compartment on the left side of the model. Follow these steps to install the battery:

Battery Installation

1. Open the battery compartment door by pressing on the release tabs.
2. Install the battery pack with the battery wires facing the rear of the model.
3. Route the battery wire through the slot near the vent.
4. Close the battery door, making sure not to pinch the battery wires. Be sure both release tabs are fully engaged with the door. Do not connect the battery pack to the ESC at this time. Note: always unplug the battery and remove from the model after use.

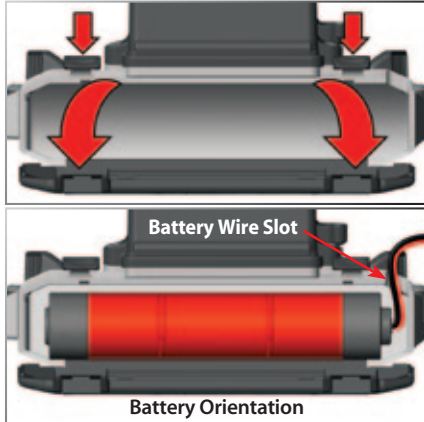

Using an Additional Battery Pack for Increased Run Time

Traxxas 1/16 models only require one battery pack, but the chassis can accept two batteries. The model can be run with two battery packs to extend run time. **The batteries must be connected in parallel**, which will combine the capacity of the two batteries (for example, two 7.2-volt 1000mAh packs connected in parallel will deliver a total capacity of 2000mAh, but total voltage will remain 7.2 volts). This is easily done with a parallel Y-harness (part #3064, sold separately). Be sure to only use the Y-harness with identical battery packs; do not mix batteries of different chemistries or capacities. **Never connect the two batteries in series — this will fail the ESC!**



When operating your model with two batteries for maximum run time, be careful to monitor the temperature of the speed control and motor to prevent overheating. If either component feels excessively hot, or the speed control's thermal overload protection activates, **stop running the model immediately and allow the components to cool.**



For best off-road handling with two battery packs, consider installing stiffer springs on your model. Traxxas offers accessory springs for this purpose; see the parts list included with your model for item numbers.

Using LiPo Battery Packs in your model.

WARNING: The XL-2.5 is not directly compatible with LiPo batteries. The XL-2.5 is not equipped with low voltage detection. For LiPo use, the XL-2.5 requires an external low-voltage detector (sold separately, consult your hobby dealer).

THE TRAXXAS HIGH CURRENT CONNECTOR

Your model is equipped with the Traxxas High-Current Connector. Standard connectors restrict current flow and are not capable of delivering the power needed to maximize the output of your model. The Traxxas connector's gold-plated terminals with a large contact surfaces ensure positive current flow with the least amount of resistance. Secure, long-lasting, and easy to grip, the Traxxas connector is engineered to extract all the power your battery has to give.



To run this model, your batteries must be equipped with Traxxas High-Current Connectors. Batteries can either be purchased new with Traxxas connectors installed or Traxxas connectors can be purchased to install on battery packs you already own. See sidebar for packages available from your hobby dealer.



Molex connector

For best performance, it is strongly recommended that you use only battery packs equipped with the Traxxas High-Current Connector. However, batteries with a Molex® connector may be used in the model in conjunction with #3062 adapter.



The following Traxxas High Current Connector packages are available from your hobby dealer. When using adapters, be careful not to exceed the current rating of the Molex connector.



Part #3060
Single Male/Female



Part #3080
2-Pack Female



Part #3061
Male Charge Adapter



Part #3070
2-Pack Male



Part #3062
Female Charge Adapter



Use the Right Batteries

Your transmitter uses AA batteries. Use new alkaline batteries, or rechargeable batteries such as NiMH (Nickel Metal Hydride) batteries in your transmitter. Make sure rechargeable batteries are fully charged according to the manufacturer's instructions.

If you use rechargeable batteries in your transmitter, be aware that when they begin to lose their charge, they lose power more quickly than regular alkaline batteries.

Caution: Discontinue running your model at the first sign of weak batteries (flashing red light) to avoid losing control.





Don't push the transmitter antenna down from the top. Pull it down from the bottom, one segment at a time, to prevent binding and kinking the antenna mast.

TQ RADIO SYSTEM CONTROLS

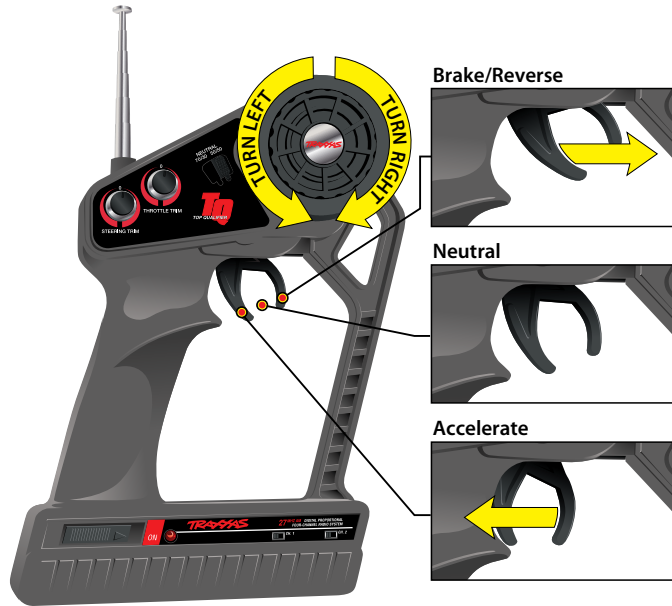

TQ RADIO SYSTEM ADJUSTMENTS

In addition to the electronic throttle and steering trim controls, your radio system features throttle neutral adjustment and servo reversing switches. **These are preset at the factory and should not require further adjustment.**

Throttle Neutral Adjustment

The throttle neutral adjustment is located on the transmitter face and controls the forward/reverse travel of the throttle trigger. Change the adjustment by pressing the button and sliding it to the desired position.

There are two settings available:

- 50/50:** Allows equal travel for both acceleration and reverse.
- 70/30:** Allows more throttle travel (70%) and less reverse travel (30%).

Note: If you change throttle travel, you will need to reprogram the electronic speed control.

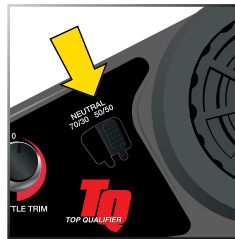

Electronic Throttle Trim

The electronic throttle trim located on the face of the transmitter adjusts the neutral (center) point of the electronic speed control. This control has been preset for you at the factory.

Electronic Steering Trim

The electronic steering trim located on the face of the transmitter adjusts the neutral (center) point of the steering servo when the servo is at rest. Adjust this control to make the model drive straight with no steering input at the wheel.

Servo Reversing Switches

The servo reversing switches are located on the front of the transmitter, next to the on/off switch. Moving a switch reverses the direction of the corresponding servo.

Each switch corresponds to a channel, as shown below. For example, if you turn the steering wheel to the right and your wheels turn left, you would move the Channel 1 switch to correct the servo direction. It may be necessary to adjust the corresponding trim control after moving a switch.

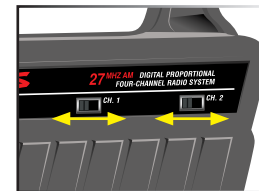

Channel	Servo
1	Steering
2	Throttle

Default Setting

TQ RADIO SYSTEM RULES

- ⊕ Each time you prepare to run your model, you must clear your frequency to be sure no one else in the area is using the same channel as you. There are six possible channels, numbered 1 through 6. Each is represented by a color. Look at the crystal plugged into the back of your transmitter to determine which channel your model is assigned to.
- ⊕ Always turn your TQ transmitter on first and off last. This procedure will help to prevent your model from receiving stray signals from another transmitter, or other source, and running out of control.
- ⊕ Always have the transmitter turned on before plugging in the battery.
- ⊕ Always use new or freshly charged batteries for the radio system. Weak batteries will limit the range of the radio signal between the receiver and the transmitter. Loss of the radio signal can cause you to lose control of your model.

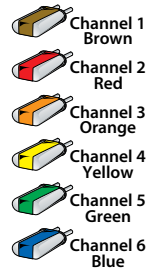

4. The on/off switch is integrated into the speed control. With the transmitter on, press the ESC set button for ½ second, until the LED shines GREEN, then immediately release the button. This turns the model on (see page 14 for more on ESC setup and operation). To turn the ESC off, press the set button until the green LED turns off. **Always disconnect your battery when the model is not in use.**
5. Turn the steering wheel on the transmitter back and forth and check for rapid operation of the steering servos. Also, check that the steering mechanism is not loose or binding. If the steering operates slowly, check for weak batteries.
6. When looking down at model, the front wheels should be pointing straight ahead. If the wheels are turned slightly to the left or right, slowly adjust the steering trim control on the transmitter until they are pointing straight ahead.
7. **Gently** apply the throttle trigger to ensure that you have full forward and reverse operation, and that the motor stops when the throttle trigger is at neutral.
8. Once adjustments are made, turn off your model, followed by the hand held transmitter.

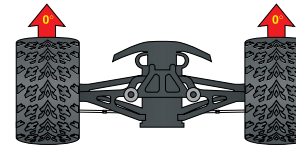

RANGE-TESTING THE TQ RADIO SYSTEM

Before each running session with your model, you should range-test your radio system to ensure that it operates properly.

1. Turn on the radio system and check its operation as described in the previous section.
2. Have a friend hold the model securely. Make sure hands and clothing are clear of the wheels and other moving parts on the model.
3. Make sure your transmitter antenna is fully extended, and then walk away from the model with the transmitter until you reach the farthest distance you plan to operate the model.
4. Operate the controls on the transmitter once again to be sure that the model responds correctly.
5. Do not attempt to operate the model if there is any problem with the radio system or any external interference with your radio signal at your location.

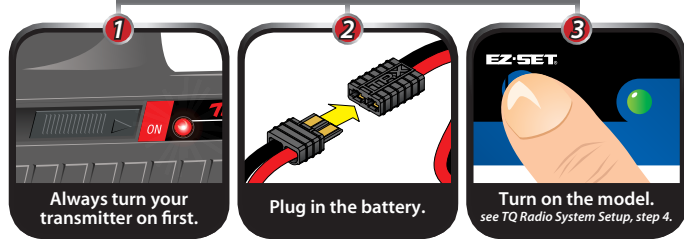

TQ RADIO SYSTEM SETUP

The TQ Radio System was pre-adjusted at the factory. The adjustment should be checked, before running the model, in case of movement during shipping. Here's how:

1. Fully extend the chrome antenna mast on the transmitter and turn the switch on. The red indicator light on the transmitter should be solid red (not flashing).
2. **Elevate the model so that all four tires are off the ground.** If you are holding the model, make sure hands and clothing are clear of the wheels and other moving parts on the model.
3. Plug the battery pack in the model into the speed control.

! Remember, always turn the TQ transmitter on first and off last to avoid damage to your model.

i Your speed control was adjusted to the radio from the factory. It is possible for the throttle trim control on the transmitter to have moved during transit or while handling the transmitter. If the motor runs when the model is switched on, then move the throttle trim control on the transmitter until the motor stops. If anything more than a slight adjustment of the throttle trim control is required, then you should readjust your speed control. Refer to the adjustments section on page 14.

! When rechargeable batteries begin to lose their charge, they will fade much faster than alkaline dry cells. Stop immediately at the first sign of weak batteries. Never turn the transmitter off when the battery pack is plugged in. The model could run out of control.



ADJUSTING THE ELECTRONIC SPEED CONTROL

XL-2.5 ESC Specifications

Input Voltage:	4-8 Cells (4.8V - 9.6V DC)
Case Size (W x D x H):	26.5 x 46.5 x 22mm
Weight:	33 Grams
Motor Limit (380 Size):	10-turns*
On-Resistance (@Trans):	0.008 Ohms
Reverse Delay:	None
BEC Voltage:	6.0V DC
Power Wire:	16 Gauge / 40mm
Input Harness:	26 Gauge / 130mm
Motor Wires:	16 Gauge / 40mm
Transistor Type:	MOSFET
PWM Frequency:	2300 Hz

*Properly geared

The electronic speed control is factory set and should not require any adjustments. These instructions are provided for your reference.

Transmitter Adjustments for the electronic speed control

Before attempting to program your ESC, it is important to make sure your TQ transmitter is properly adjusted (set back to the factory defaults). Otherwise, you may not get the best performance from your speed control.

The transmitter should be adjusted as follows:

1. Set the throttle neutral switch to the 50/50 setting. This adjusts the transmitter's throttle trigger throw to 50% for throttle and 50% for braking and reverse.
2. Set the throttle trim control to the middle "0" setting.
3. Set the Channel 2 servo reversing switch to the left position. Do not change the position of any of the servo reversing switches after programming the ESC.
4. You are now ready to program your speed control.

Setup Programming (Calibrating your ESC and transmitter)

Read through all of the following programming steps before you begin. If you get lost during programming or receive unexpected results, simply unplug the battery, wait a few seconds, plug the battery back in, and start over.

1. Disconnect each of the motor wires between the ESC and the motor. This is a precaution to prevent runaway when the speed control is turned on before it is programmed.
2. Turn on the transmitter (with the throttle at neutral).
3. Connect a fully charged battery pack to the ESC.
4. Press and hold the EZ-Set button (A). The LED will first turn green and then red. Release the EZ-Set button.
5. When the LED blinks RED ONCE. Pull the throttle trigger to the full throttle position and hold it there (B).
6. When the LED blinks RED TWICE. Push the throttle trigger to the full reverse and hold it there (C).

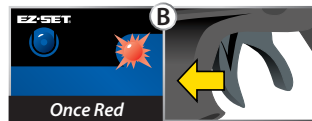

7. When the LED turns solid GREEN, programming is complete. The LED will continuously shine green indicating the ESC is on and at neutral (D).



ESC Operation

To operate the speed control and test the programming, place the vehicle on a stable block or stand so all of the driven wheels are off the ground. Reconnect the motor wires. Always make sure that objects and fingers are clear of the wheels.

1. With the transmitter on, press the EZ-Set button for ½ second, until the LED shines GREEN, then immediately release the button. This turns on the ESC. If you press and release too quickly, you may hear the steering servos jump but the LED may not stay on. (Note: If the throttle is not at neutral or if the throttle trim has been altered, the LED will turn off after one second and the wheels may begin to drive.)
2. Apply forward throttle. The LED will turn off until full throttle power is reached. At full throttle, the led will shine GREEN.
3. Move the trigger forward to apply the brakes. Note that braking control is fully proportional. The LED will turn off until full braking power is reached. At full brakes, the LED will shine GREEN.
4. Return the throttle trigger to neutral. The LED will shine GREEN.
5. Move the throttle trigger forward again to engage reverse (Profile #1). The LED will turn off. Once full reverse power is reached, the LED will shine GREEN.
6. To stop, return the throttle trigger to neutral. (Note: There is no programmed delay when changing from reverse to forward. Use caution to avoid slamming the speed control from reverse to forward. On high-traction surfaces, this could result in transmission or driveline damage.)
7. To turn the ESC off, press the EZ-Set button until the green LED turns off.

Thermal Shutdown Protection

The XL-2.5 speed control is equipped with thermal shutdown protection to guard against overheating caused by excessive current flow. If the operating temperature exceeds safe limits, the ESC will automatically shut down and the ESC LED will flash red. The LED on the face of the ESC will continuously flash red, even if the throttle trigger is moved back and forth. After the speed control cools down to a safe level, the LED will continuously shine green. The ESC will once again function normally.

ESC Profile Selection

The speed control is factory set to Profile #1. To change the profile, follow the steps on described below. The speed control should be connected to the receiver and battery, and the transmitter should be adjusted as described previously. The profiles are selected by entering the programming mode.

ESC Profile Description

Profile #1 (Sport Mode): 100% Forward, 100% Brakes, 100% Reverse

Profile #2 (Race Mode): 100% Forward, 100% Brakes, No Reverse

Profile #3 (Training Mode): 50% Forward, 100% Brakes, 50% Reverse

Selecting Sport Mode (Profile #1)

1. Turn on your transmitter and connect a fully charged battery pack to the ESC.
2. With the ESC off, press and hold the EZ-Set button until the light turns solid green, then solid red and then begins blinking red (indicating the Profile numbers).
3. When the light blinks red once, release the EZ-Set button.
4. The light will then turn green and the model is ready to drive.

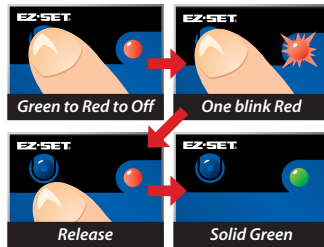

Selecting Race Mode (Profile #2)

1. Turn on your transmitter and connect a fully charged battery pack to the ESC.
2. With the ESC off, press and hold the EZ-Set button until the light turns solid green, then solid red and then begins blinking red (indicating the Profile numbers).
3. When the light blinks red twice, release the EZ-Set button.
4. The light will then turn green and the model is ready to drive.

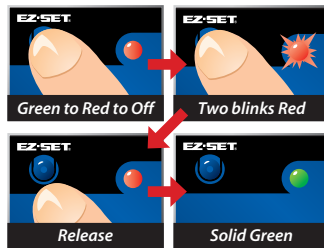

Selecting Training Mode* (Profile #3)

1. Turn on your transmitter and connect a fully charged battery pack to the ESC.
2. With the ESC off, press and hold the EZ-Set button until the light turns solid green, then solid red and then begins blinking red (indicating the Profile numbers).
3. When the light blinks red three times, release the EZ-Set button.
4. The light will then turn green and the model is ready to drive.

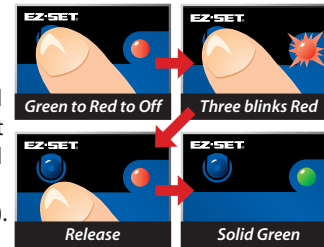

Note: If you missed the mode you wanted, keep the EZ-Set button pressed down and the blink cycle will repeat until a Mode is selected.



Patent Pending Training Mode (Profile #3) reduces forward and reverse throttle by 50%. Training Mode is provided to reduce the power output allowing beginning drivers to better control the model. As driving skills improve, simply change to Sport or Race Mode for full-power operation.



Tip For Fast Mode Changes
The ESC is set to Profile 1 (Sport Mode) as the default. To quickly change to Profile 3 (Training Mode), with the transmitter on and the ESC turned off, press and hold the SET button until the light blinks red three times and then release. For full power, turn off the ESC then quickly change back to Profile 1 (Sport Mode) by pressing and holding the SET button until the light blinks red one time and then releasing.

DRIVING YOUR MODEL

Now it's time to have some fun! This section contains instructions on driving and making adjustments to your model. Before you go on, here are some important precautions to keep in mind.

- ⚠ Allow the model to cool for a few minutes between runs. This is particularly important when using high capacity battery packs that allow extended periods of running. Monitoring temperatures will extend the lives of the battery and motor.
- ⚠ Do not continue to operate the model with low batteries or you could lose control of it. Indications of low battery power include slow operation and sluggish servos (slow to return to center). Stop immediately at the first sign of weak batteries. When the batteries in the transmitter become weak, the red power light will begin to flash. Stop immediately and install new batteries.
- ⚠ Do not drive the model at night, on public streets, or in large crowds of people.
- ⚠ If the model becomes stuck against an object, do not continue to run the motor. Remove the obstruction before continuing. Do not push or pull objects with the model.
- ⚠ Because the model is controlled by radio, it is subject to radio interference from many sources beyond your control. Since radio interference can cause momentary losses of control, allow a safety margin of space in all directions around the model in order to prevent collisions.
- ⚠ Use good, common sense whenever you are driving your model. Intentionally driving in an abusive and rough manner will only result in poor performance and broken parts. Take care of your model so that you can enjoy it for a long time to come.
- ⚠ High performance vehicles produce small vibrations which may loosen hardware over time. Frequently check wheel nuts and other screws on your vehicle to ensure that all hardware remains properly tightened.

About Run Time

A large factor affecting run time is the type and condition of your batteries. The milliamp hour (mAh) rating of the batteries determines how large their "fuel tank" is. A 2000 mAh battery pack will theoretically run twice as long as a 1000 mAh pack. Because of the wide variation in the types of batteries that are available and the methods with which they can be charged, it's impossible to give exact run times for the model. Another major factor which affects

run time is how the model is driven. Run times may decrease when the model is driven repetitively from a stop to top-speed and with repetitive hard acceleration.

Tips for Increasing Run Time

- ⚠ Use batteries with the highest mAh rating you can purchase.
- ⚠ Use the included charger or a high-quality peak-detecting charger.
- ⚠ Read and follow all maintenance and care instructions provided by the manufacturer of your batteries and charger.
- ⚠ Keep the ESC cool. Get plenty of airflow across the ESC heat sinks.
- ⚠ Lower your gear ratio. Installing smaller pinion gears will lower your gear ratio and cause less power draw from the motor and batteries, and reduce overall operating temperatures.
- ⚠ Maintain your model. Do not allow dirt or damaged parts to cause binding in the drivetrain. Keep the motor clean.

mAh Ratings and Power Output

The mAh rating of the battery can effect your top speed performance. The higher capacity battery packs experience less voltage drop under heavy load than low mAh rated packs. The higher voltage potential allows increased speed until the battery begins to become discharged

RUNNING IN WET CONDITIONS

Your model is designed with water-resistant features to protect the electronics in the model (receiver, servos, electronic speed control). This gives you the freedom to have fun driving your model through puddles, wet grass, snow, and other wet conditions. Though highly water resistant, the model should not be treated as though it is submersible or totally, 100% waterproof. Water resistance applies only to the installed electronic components. Running in wet conditions requires additional care and maintenance for the mechanical and electrical components to prevent corrosion of metal parts and maintain their proper function.

Precautions

- ⚠ **Without proper care, some parts of your model can be seriously damaged due to contact with water. Know that additional maintenance procedures will be required after running in wet conditions in order to maintain the performance of your model. Do not run your model in wet conditions if you are not willing to accept the additional care and maintenance responsibilities.**



- ⚠ Not all batteries can be used in wet environments. Consult your battery manufacturer to see if their batteries can be used in wet conditions.
- ⚠ The Traxxas TQ transmitter is not water resistant. Do not subject it to wet conditions such as rain.
- ⚠ Do NOT operate your model during a rain storm or other inclement weather where lightning may be present.
- ⚠ Do NOT allow your model to come in contact with salt water (ocean water), brackish water (between fresh water and ocean water), or other contaminated water. Salt water is highly conductive and highly corrosive. Use caution if you plan to run your model on or near a beach.
- ⚠ Even casual water contact can reduce the life of your motor. Special care must be taken to modify your gearing and/or your driving style in wet conditions to extend the life of the motor (details below).

Before Running Your Vehicle in Wet Conditions

1. Consult the section “After Running Your Vehicle in Wet Conditions” before proceeding. Make sure you understand the additional maintenance required with wet running.
2. The wheels have small holes molded in to allow air to enter and exit the tire during normal running. Water will enter these holes and get trapped inside the tires if holes are not cut in the tires. Cut two small holes (4mm or 3/16" diameter) in each tire. Each hole should be near the tire centerline, 180 degrees apart.
3. Confirm that the receiver box O-ring and cover are installed correctly and secure. Make sure the screws are tight and the blue O-ring is not visible protruding from the edge of the cover.
4. Confirm that your batteries can be used in wet conditions.
5. Use lower gearing (smaller pinion gears) when running in mud, deep puddles, snow, or other similar situations that will restrict the tires and put much higher loads on the motor.

Motor Precautions

- ⚠ Motor life can be greatly reduced in mud and water. If the motor get excessively wet or submerged, use very light throttle (run the motor slowly) until the excess water can run out. Applying full throttle to a motor full of water can cause rapid motor failure. Your driving habits will determine motor life with wet motor. Do not submerge the motor under water.

- ⚠ Do not gear the motor by temperature when running in wet conditions. The motor will be cooled by water contact and will not give an accurate indication of appropriate gearing.

After Running Your Vehicle in Wet Conditions

1. Drain the tires by spinning the tires at full throttle to “sling” the water out. An easy way to do this is to remove the body and set the model upside down on a flat surface. Apply full throttle so the tires spin and throw the excess water out of the holes you cut into the tires.
2. Remove the battery.
3. Rinse excess dirt and mud off the model with low-pressure water, such as from a garden hose. Do NOT use pressure washer or other high-pressure water. Avoid directing water into the bearings, transmission, differentials, etc.
4. Blow off the model with compressed air (optional, but recommended). Wear safety glasses when using compressed air.
5. Remove the wheels from the model
6. Spray all the bearings, drivetrain, and fasteners with WD-40® or similar water displacing light oil
7. Let the model stand or you may blow off with compressed air. Placing the model in a warm sunny spot will aid drying. Trapped water and oil will continue to drip from the model for a few hours. Place it on a towel or piece of cardboard to protect the surface underneath.
8. As a precautionary step, remove the sealed receiver box cover. While unlikely, humidity or tiny amounts of moisture or condensation may enter the receiver box during wet running. This can cause long-term problems with the sensitive electronics in the receiver. Removing the receiver box cover during storage allows the air inside to dry. This step can improve the long-term reliability of the receiver. It is not necessary to remove the receiver or unplug any of the wires.
9. **Additional Maintenance:** Increase your frequency of disassembly, inspection and lubrication of the following items. This is necessary after extended wet use or if the vehicle will not be used for an extended period of time (such as a week or longer). This additional maintenance is needed to prevent any trapped moisture from corroding internal steel components.
 - **Stub axle housing bearings:** Remove, clean, and re-oil the bearings.
 - **Front and rear differential:** Remove, disassemble, clean, and re-grease the differentials. Refer to your exploded view diagrams for help with disassembly and reassembly.

- **Transmission:** Remove, disassemble, and clean the transmission components. No grease is required for the nylon gears. Refer to your exploded view diagrams for help with disassembly and reassembly.
- **Motor:** Remove the motor, clean with aerosol motor cleaner, and re-oil the bushings (Titan 380 motor) or bearings (Velineon 380 motor) with lightweight motor oil. Be sure to wear eye protection when using spray aerosol cleaners.



RECEIVER BOX: MAINTAINING A WATERTIGHT SEAL
Removing and Installing Radio Gear

The unique design of the receiver box allows the removal and installation of the receiver without losing the ability to maintain a watertight seal in the box. The patent-pending wire clamp feature gives you the ability to also install aftermarket radio systems and maintain the watertight features of the receiver box.

Removing the Receiver

1. Remove the 2.5x8mm screws that secure the wire clamp.
2. Remove the 2.5x8mm screws that secure the receiver box lid to the chassis. Lift the lid up and toward you to disengage the lid's tab from its slot in the chassis.
3. You can now access the receiver. Unplug the servo cables from the receiver and remove the receiver.

Receiver Installation

1. Route the antenna wire out of the receiver box cover (A). Place the cover on the chassis.
2. Route the servo and speed control leads into the receiver box cover. Use the molded-in wire guides to align the servo and speed control leads and antenna wire (B).
3. Apply a small bead of silicone grease (Traxxas part #1647) to the wire clamp (C).
4. Install the wire clamp and tighten the two 2.5x8mm screws securely (D).

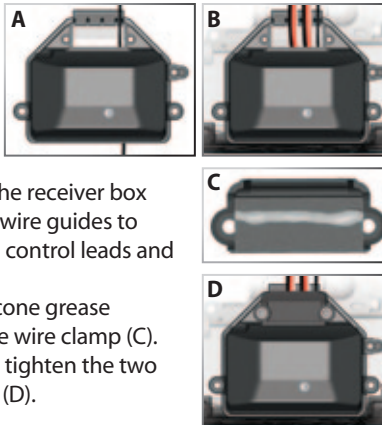

5. Lift the receiver box cover and plug the servo and speed control leads into the receiver (E). Refer to page 8 for the wiring diagram.
6. Bundle the wires so they fit beneath the receiver box cover. You may secure the receiver to the chassis with mounting tape if you wish, but this is not required. The excess wire beneath the cover will prevent the receiver from rattling.
7. Make sure the blue O-ring is properly seated into the groove around the receiver cover base so the cover will not pinch or damage the O-ring. Snap the receiver box cover into place (F).
8. Inspect the cover to make sure the O-ring is not visible. If it is, remove the cover and reposition the O-ring. With the O-ring and cover properly seated, install the 2.5x8mm screws and tighten them securely (G).

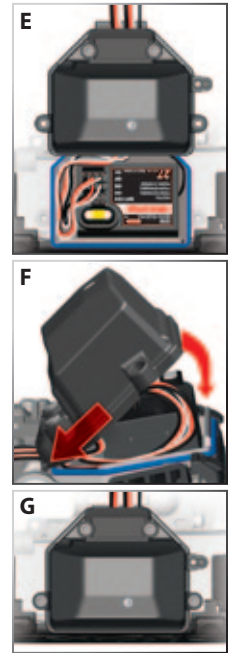

TUNING ADJUSTMENTS

Your model is factory-tuned for optimum performance in a wide variety of off-road conditions. To tailor the performance and handling of your model to suit your driving style and terrain, the model has a number of adjustable features. Gearing, shock preload and damping, ride height and wheel camber can all be easily adjusted.

SUSPENSION TUNING

Ride Height Adjustment

Your model has threaded shock bodies that make it easy to adjust ride height. Threading the shocks' preload collars away from the caps will raise the vehicle's ride height (the distance from the chassis to the ground), and reduce the suspension's down travel, also known as 'sag' or 'droop'. This can be helpful in rugged terrain where extra ground clearance is needed. However, the vehicle's center of gravity (CG) will be raised, making it less stable.

Threading the shocks' preload collars toward the caps will lower the vehicle's ride height and increase the suspension's droop. This will lower the vehicle's CG and improve handling, but it will also reduce ground clearance.

From the factory, your model is set up as shown in the illustration above. At rest, the suspension sags about 1/3 of its total travel. This allows the suspension to extend so the wheel can drop into depressions over rough terrain. This leaves 2/3 of the total suspension travel for compression when absorbing bumps and landing jumps. These settings are ideal for most surfaces, and only small changes in ride height should be required to fine-tune the vehicle's handling for your particular surface.

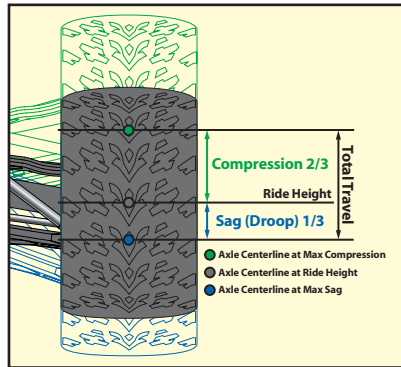

Shock Oil

The 4 oil-filled shocks (dampers) effectively control the suspension movement by preventing the wheels and tires from continuing to "bounce" after rebounding from a bump. Changing the oil in the shocks can vary the suspension damping effect. Changing the oil to a higher viscosity oil will increase damping. Lowering the viscosity of the oil will cause the suspension damping to be reduced. Damping should be increased (with higher viscosity oil) if the model is bottoming easily over jumps. Damping should be decreased (with thinner viscosity oil) if the model is hopping over small bumps and feels unstable. The viscosity of shock oil is affected by extremes in operating temperature; an oil of certain viscosity will become less viscous at higher temperatures and more viscous at lower temperatures. Operating in regions with cold temperatures may require lower viscosity oil. Your model's shocks are filled with SAE 60W oil. Only use 100% silicone oil in the shock.

Replacing Shock Oil

The shocks have to be removed from the vehicle and disassembled to change the oil.

1. Remove the lower spring retainer and shock spring.
2. Remove the upper shock cap. If you cannot unscrew the cap with your fingers, pass the 2mm 'L' wrench through the cap's eyelet so you can apply more leverage. Turn the cap counterclockwise to loosen it.



3. Empty the used shock oil from the shock body.
4. Fill the shock with new silicone shock oil up to the top of the shock body.
5. Slowly move the piston up and down (always keeping it submerged in oil) to release the air bubbles. Let the shock sit for a few minutes to allow any remaining air bubbles to surface.
6. Slowly thread the upper cap with the installed shock bladder onto the shock body. The excess oil will bleed out of the small hole in the shock cap.
7. Tighten the shock cap until snug.



Important: The shocks are assembled at the factory with a center-to-center distance (between the rod end balls) of 47.75mm. Any time the shocks are removed and disassembled, this distance should be checked to ensure proper operation of the suspension.





A camber gauge (available at your local hobby shop) can be a useful tool for alignment setting.



To achieve a good starting point for the slipper clutch, tighten the slipper clutch adjusting nut clockwise until the slipper clutch adjusting spring fully collapses (do not over tighten), and then turn the slipper clutch nut counter-clockwise $\frac{3}{4}$ to 1 turn.

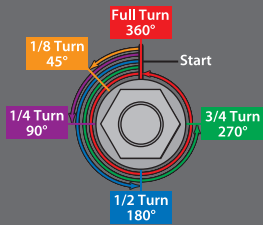

Static Camber Adjustment

The wheels can be set to have either positive or negative camber (see illustration below). The camber angle changes as the wheel moves up and down through its range of travel. Static camber is the camber angle at the wheel when the vehicle is set at its normal, stationary ride height.

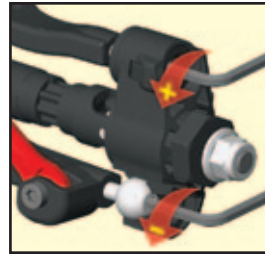

The suspension pivot balls located in the axle carriers adjust the static camber. Camber is factory-set at negative 1-degree, with the pivot balls threaded all the way into the suspension arms. To adjust static camber, insert the supplied 2mm hex wrench into the pivot ball (compressing the suspension until the arms are parallel to the ground will allow for easier hex wrench engagement). Negative camber can be increased by unthreading the lower pivot ball. Zero camber or positive camber (not recommended) can be achieved by unthreading the upper pivot ball. Note that camber changes will also effect the toe angle of the wheel being adjusted.

Static Camber Base Factory Settings

Front: 1-degree negative camber each side

Rear: 1-degree negative camber each side

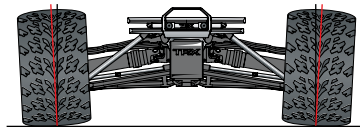

Positive camber

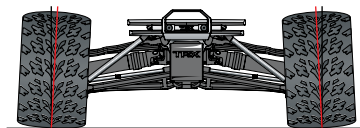

Negative camber

TRANSMISSION TUNING

Adjusting the Slipper Clutch

Your model is equipped with an adjustable Torque Control slipper clutch which is built into the large spur gear. The purpose of the slipper clutch is to prevent over-stressing of the drivetrain and transmission gears. It may also be used to regulate the amount of power sent to the rear wheels to prevent tire spin. When it slips, the slipper clutch makes a high-pitch, whining noise.



To adjust the slipper clutch, first remove the receiver box cover. Next, remove the single large hex screw from the motor plate using the supplied 2.5mm wrench. Then rotate the motor and mount to the side of the model. The slipper clutch is integrated into the main spur gear on the transmission.



The slipper clutch is adjusted using the spring-loaded locknut on the slipper shaft. Use the supplied universal wrench. To tighten or loosen the slipper nut, insert the 1.5mm hex wrench into the hole in the end of the slipper shaft. This locks the shaft for adjustments. Turn the adjustment nut clockwise to tighten (less slippage) and counter-clockwise to loosen (more slippage).

Tuning the Sealed Gear Differentials

The 1/16 E-Revo's front and rear gear differentials allow the left and right wheels to spin at different speeds while turning so that the tires do not scuff or skid. This decreases the turning radius and increases steering performance.

The performance of the differentials can be tuned for different driving conditions and performance requirements. The differentials are filled with silicone differential fluid, and are sealed to maintain consistent long-term performance. Changing the oil in the differential with either lower or higher viscosity oil will vary the performance characteristics of the differentials. Changing to a higher viscosity oil in the differential will reduce the tendency for power to be transferred to the wheel with the least traction. You may notice this when making sharp turns on slick surfaces. The unloaded wheels on the inside of the turn have

the least traction and tend to spin up to extremely high rpms. Higher viscosity (thicker) oil causes the differential to act like a limited-slip differential, distributing more equal power to the left and right wheels. Your model will generally benefit from higher viscosity oil when climbing, rock crawling, or racing on low traction surfaces. **Note:** Heavier oil will allow power to be transferred even with one or more tires off the ground. This can make the vehicle more likely to overturn.

From the factory, both the differentials are filled with SAE 30,000W viscosity silicone oil. Only use silicone oil in the differentials. Traxxas sells SAE 10,000W and SAE 50,000W viscosity oil (see your parts list). The differentials have to be removed from the vehicle and disassembled to change/replace oil.

MOTOR AND GEARING

Extensive testing has been done to determine the best gear ratios for the 1/16 E-Revo. The stock gearing balances power, speed, and efficiency to optimize the performance of the models. However, you may wish to try different gear ratios in order to customize the performance of your model. The gearing chart on this page shows appropriate gearing for both models.

By installing a pinion with fewer teeth, or a spur gear with more teeth, the transmission's final drive ratio is increased. This means greater rpm is required to achieve a given speed. Using a numerically higher gear ratio will increase torque, but reduce top speed. Installing a pinion with more teeth, or a spur gear with fewer teeth, will decrease the final drive ratio, which will generally increase top speed but reduce torque. However, installing too large a pinion will "overgear" the model, which will reduce performance and may overheat the motor and speed control. Use the following formula to calculate the overall ratio for combinations not listed on the gear chart:

$$\frac{\text{\# Spur Gear Teeth}}{\text{\# Pinion Gear Teeth}} \times 5.04 = \text{Final Gear Ratio}$$

Motor Installation

To access the motor, remove the gear cover by removing the single screw on the top of the gear cover. The motor uses an aluminum mount for quick, easy motor access and gearing adjustment.

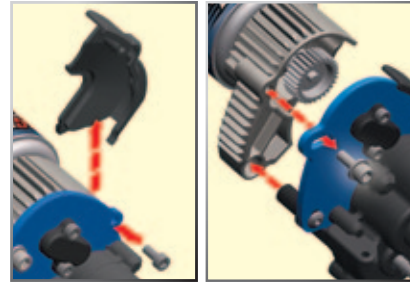

To remove the motor, first open the right battery door and slide out the ESC. Next, remove the single large hex screw using the supplied 2.5mm wrench. Then rotate the motor and mount to the side of the model, and slide backward off the post.

Pinion Gear Installation Instructions

1. Remove the motor as described in *Motor Installation*.
2. Use a 1.5mm wrench to loosen the pinion's set screw. Remove the pinion.
3. Place the replacement pinion gear onto the motor shaft. Align the set screw hole with the flat side of the shaft.
4. Thread a 1.5mm set screw into the pinion gear but do not tighten it yet.
5. Slide the pinion gear down the motor shaft so the wrench shaft fits into the notch in the motor mount, as shown. Tighten the set screw.



Adjusting Gear Mesh

Incorrect gear mesh is the most common cause of stripped spur gears. Gear mesh should be checked and adjusted anytime a gear is replaced. Access the gears by removing the single screw on the top gear cover.

To set the gear mesh, cut a narrow strip of notebook paper and run it into the gear mesh of the motor. The motor is mounted

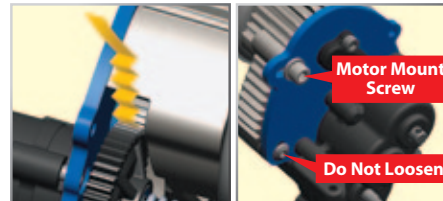

to an aluminum motor mount. Loosen the single motor mount screw with the provided 2.5mm wrench to slide the motor mount.

Gearing Compatibility Chart

The chart on the left shows a full range of gear combinations. The stock ratio for is shown in green. The gear combinations in red are not suitable when using the included 6-cell battery, speed control and motor. These gear combinations have been included in this chart as they may be used with certain other aftermarket equipment combinations.

		Spur Gear		
		45	50	55
Pinion Gear	16	-	-	17.33
	17	-	-	16.31
	18	-	-	15.40
	19	-	-	14.59
	20	-	-	13.86
	21	-	-	13.20
	22	-	11.45	12.60
	23	-	10.96	12.05
	24	-	10.50	11.55
	25	-	10.08	11.09
	26	8.72	9.69	10.66
	27	8.40	9.33	10.27
	28	8.10	9.00	9.90
	29	7.82	8.69	9.56
	30	7.56	8.40	9.24
	31	7.32	8.13	8.94
	32	7.09	7.88	8.66
	33	6.87	7.64	8.40
	34	6.67	7.41	8.15
	35	6.48	7.20	7.92
	36	6.30	7.00	-
	37	6.13	6.81	-
	38	5.97	6.63	-
	39	5.82	6.46	-
	40	5.67	6.30	-
	41	5.53	-	-
	42	5.40	-	-
43	5.27	-	-	
44	5.15	-	-	
45	5.04	-	-	
46	-	-	-	

- Stock
- Usable range
- Requires aftermarket 540 motor to fit
- Not recommended with stock ESC, motor and batteries
- Does not fit

Slide the motor and pinion gear into the spur gear. Retighten the motor mount screw and then remove the strip of paper. You should be able to run a fresh strip of paper through the gears without binding them. Gear mesh can be checked visually by removing the gear viewing port cover.

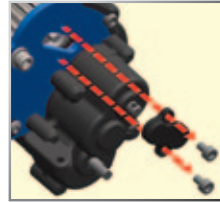

Gear Viewing Port
Cover Removal

WHEELS AND TIRES

Your model uses 12mm axle hexes which allow many types of aftermarket tires and wheels to be adapted for use on your model. Most will affect the overall width and the suspension geometry of the model. The offsets and dimensions designed into the model's wheels are intentional; therefore, Traxxas cannot recommend the use of other non-Traxxas wheels with different specifications. Experimentation with different types of tires is recommended to see which ones work the best on the terrain where the model is run. Soft compound tires with many short spikes generally work better on hard, dry surfaces. In loose dirt, a tire with large spikes should perform better. Foam tires can be fitted for use on pavement or indoor carpet tracks. See your parts list for accessory wheels and tires.

When selecting tires, consider the overall diameter of the tire. If the overall diameter is significantly larger than the stock tire's diameter, you will need to use a smaller pinion gear to compensate for the larger tire. If you wish to install tires with a diameter greater than 4 inches or 100mm, Traxxas suggests you configure the transmission for 'underdrive' gearing. Details on making this simple modification are available at Traxxas.com.

Your model requires timely maintenance in order to stay in top running condition. **The following procedures should be taken very seriously.**

Inspect the vehicle for obvious damage or wear. Look for:

1. Cracked, bent, or damaged parts
2. Check the wheels and steering for binding.
3. Check the operation of the shock absorbers.
4. Check the wiring for any frayed wires or loose connections.
5. Check the mounting of the receiver and servo(s) and speed control.
6. Check the tightness of the wheel nuts with a wrench.
7. Check the operation of the radio system, especially the condition of the batteries.
8. Check for any loose screws in the chassis structure or suspension.
9. Inspect the gears for wear, broken teeth, or debris lodged between the teeth.
10. Check the tightness of the slipper clutch.
11. Check the tightness of the front pivot balls.

Other periodic maintenance:

☞ Slipper clutch pad (friction material):

Under normal use, the friction material in the slipper clutch should wear very slowly. If the slipper clutch fails to provide consistent performance or slips even when the adjustment nut is fully tightened, disassemble the slipper clutch and replace the slipper pad. Inspect the spur gear and pressure plate for wear or damage and replace if necessary.



- #### ☞ Motor:
- Every 10-15 runs, remove, clean, and lubricate the motor. Use a product such as electric motor cleaning spray to flush dirt out of the motor. After cleaning, lubricate the bushings at each end of the motor with a drop of light-weight electric motor oil.

- #### ☞ Chassis:
- Keep the chassis clean of accumulated dirt and grime. Periodically inspect the chassis for damage.

- #### ☞ Shocks:
- Keep the oil level in the shocks full. Use only 100% pure silicone shock oil to prolong the life of the seals. If you are experiencing leakage around the top of the shock, inspect the bladder in the top cap for signs of damage or distortion from overtightening. If the bottom of the shock is leaking, then it is time for a rebuild. The Traxxas rebuild kit for two shocks is part #7062.

- #### ☞ Suspension:
- Periodically inspect the model for signs of damage such as bent or dirty suspension pins, bent turnbuckles, loose screws, and any signs of stress or bending. Replace components as needed.

- #### ☞ Driveline:
- Inspect the driveline for signs of wear such as worn drive yokes, dirty axle half shafts, and any unusual noise or binding. Remove the gear cover and inspect the spur gear for wear and check the tightness of set screws in the pinion gears. Tighten, clean, or replace components as needed.

Storage

When you are through running the model for the day, blow it off with compressed air or use a soft bristled paint brush to dust-off the vehicle. Always disconnect and remove the battery from the model whenever the model is stored. If the model will be stored for a long time, then also remove the batteries from the transmitter.

Keep this manual and the other documents included with your model for future reference. If you misplace your manual or any of the documents, they may be downloaded at Traxxas.com.

If you have any questions about your model or its operation, call the Traxxas Technical Support line toll-free at: **1-888-TRAXXAS (1-888-872-9927)***

Technical support is available Monday through Friday from 8:30am to 9:00pm central time.



Always wear eye protection when using compressed air or spray cleaners and lubricants.



1/16
E REVO

OWNER'S MANUAL

MODEL 7105

TRAXXAS

1100 KLEIN ROAD, PLANO TEXAS 75074

1-888-TRAXXAS