



PARTS CATALOG FOR
1/5TH SCALE NITRO POWERED MOTORBIKE

No.6301-F



DUCATI 999_R
TESTASTRETTA



Official Product under license of Ducati Motor Holding S.p.A.

Manufactured by **THUNDER TIGER CORPORATION**

<http://www.thundertiger.com>

FRONT ASSEMBLY

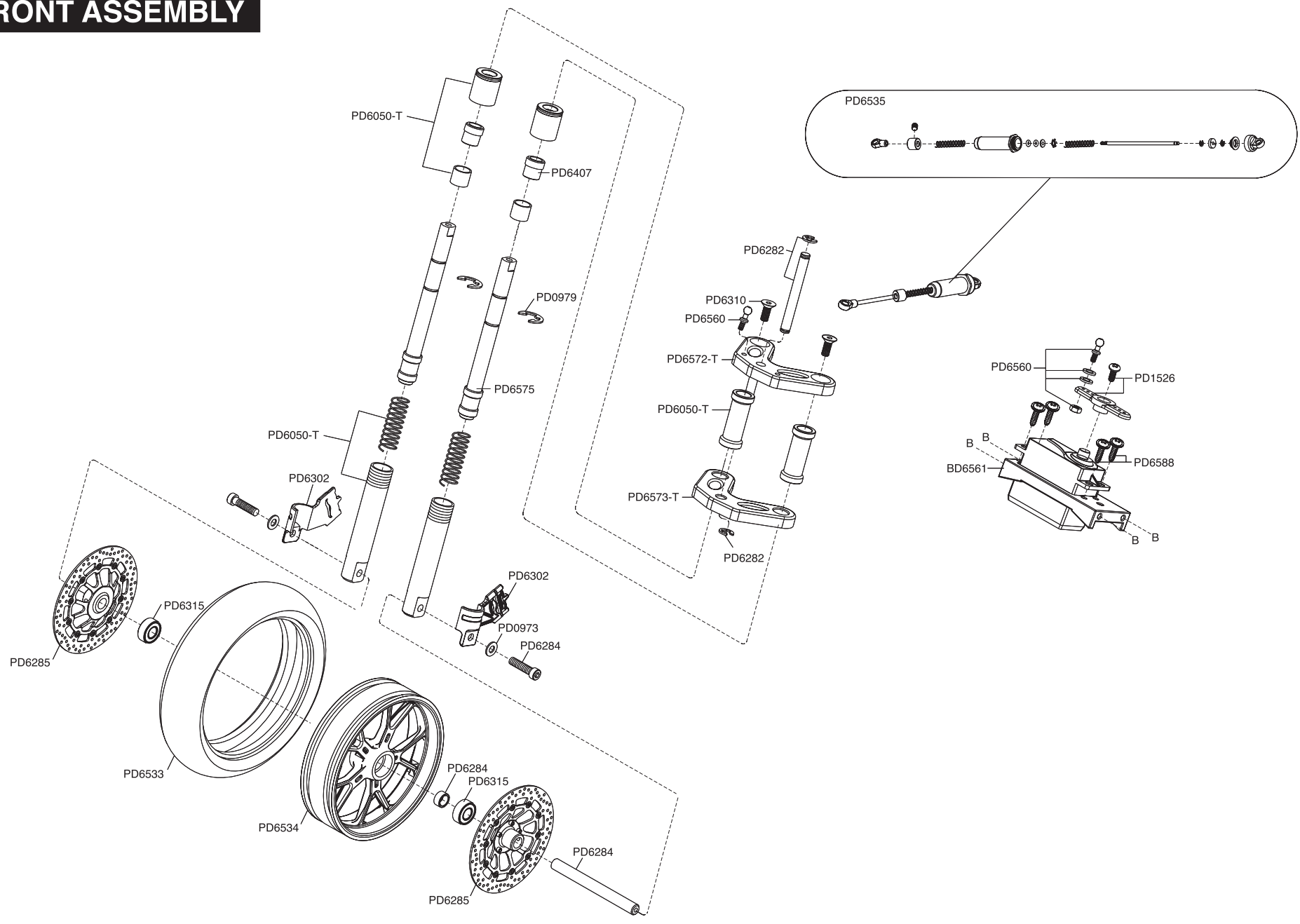

REAR ASSEMBLY

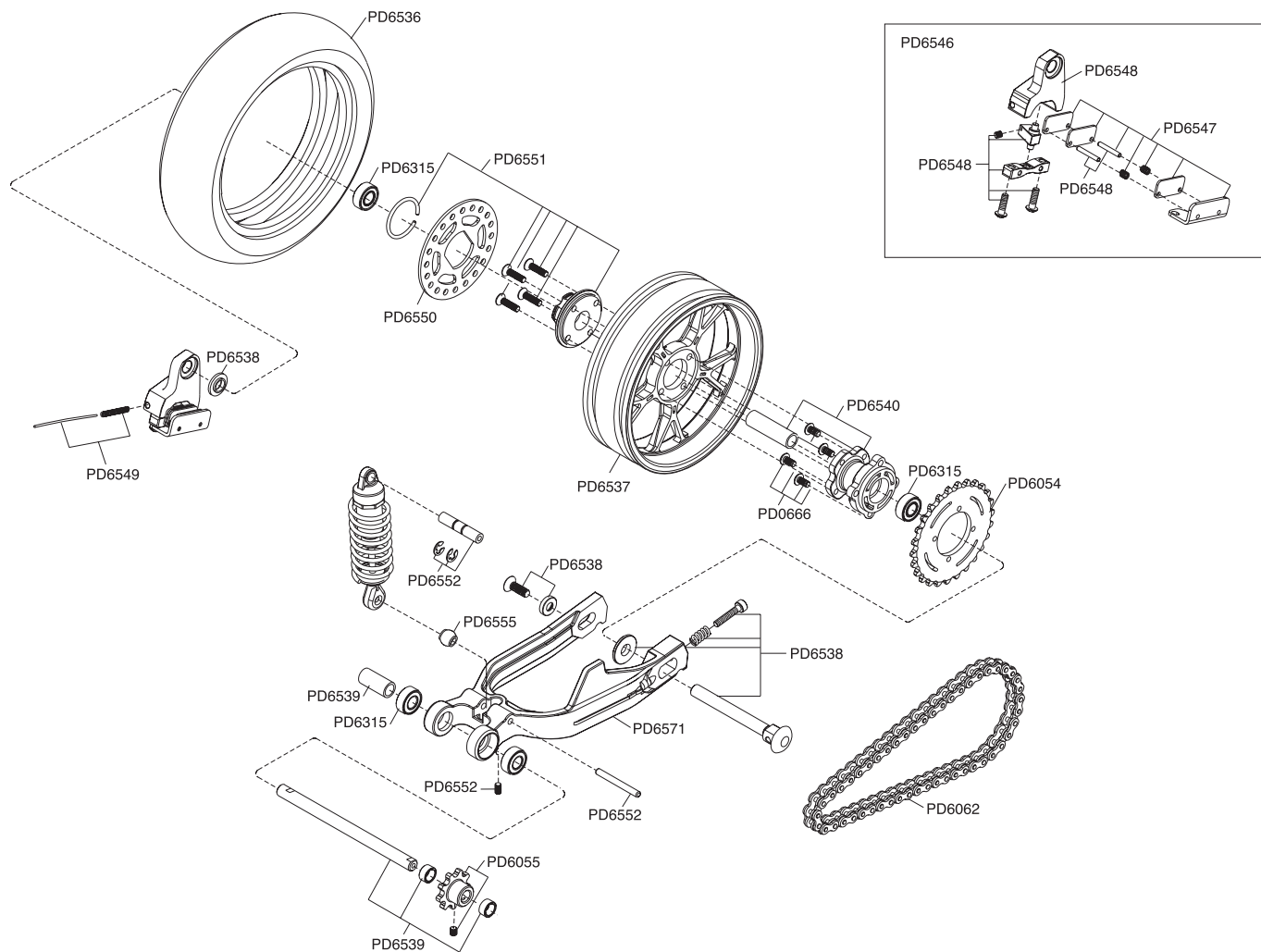

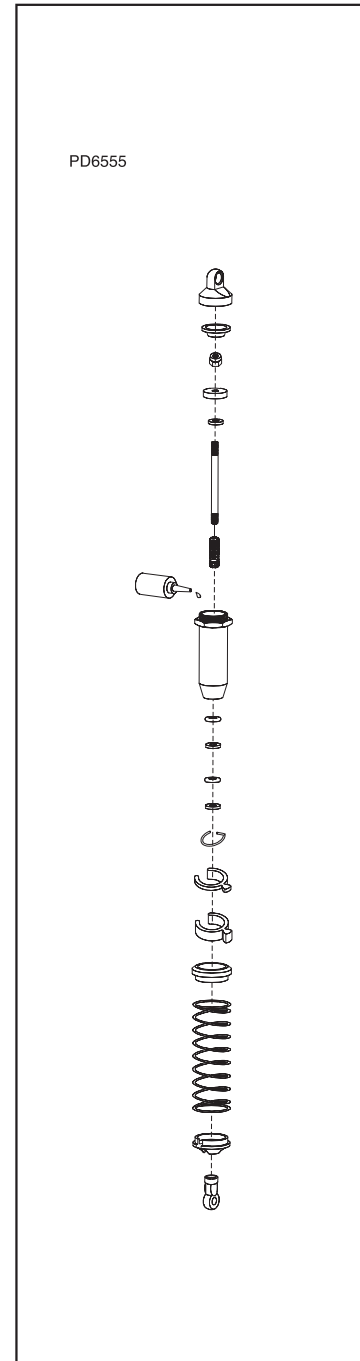
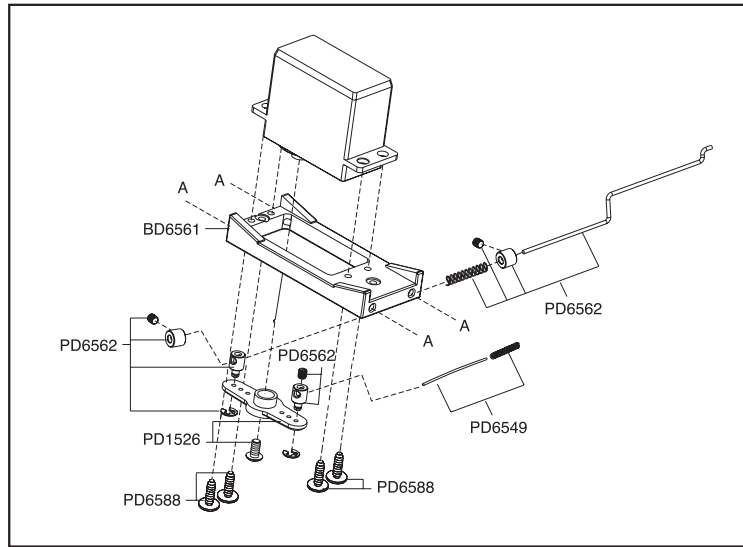
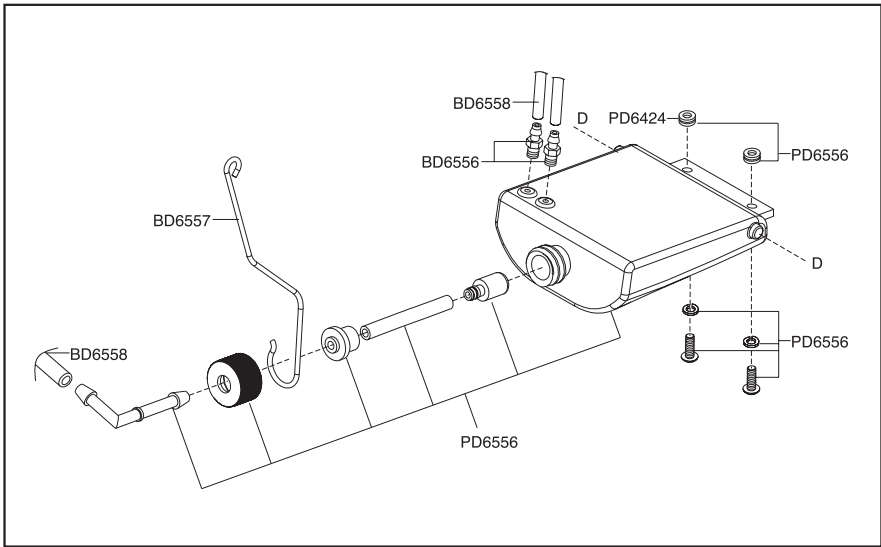

ENGINE ASSEMBLY

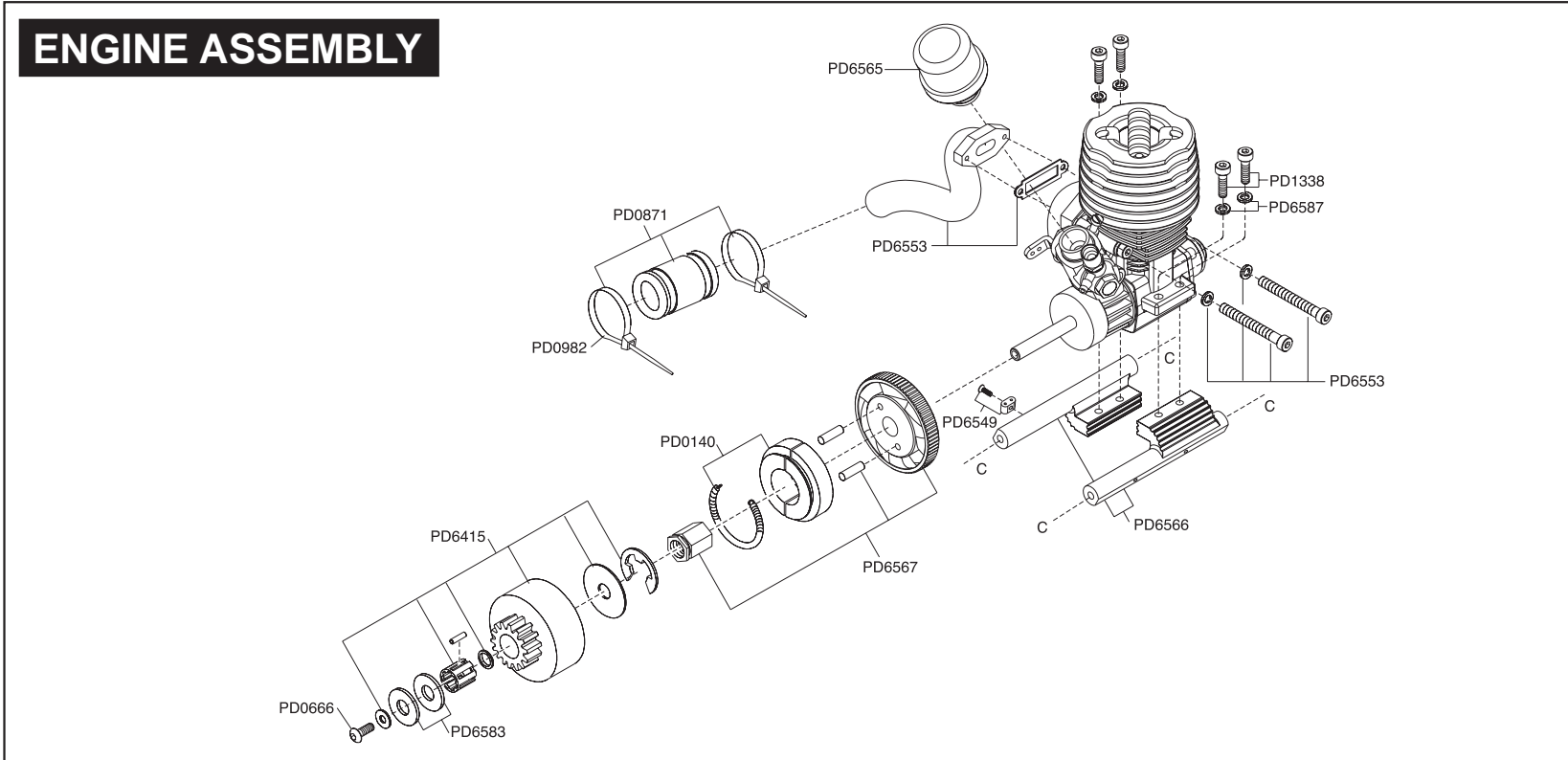

DUCATI 999R PARTS LIST

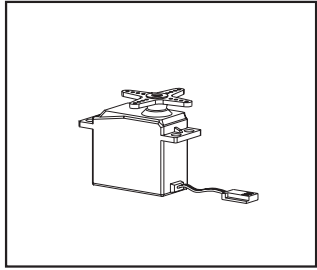

8114 SERVO

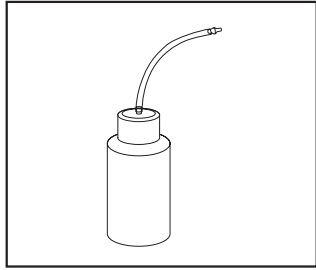

1104 FUEL BOTTLE,100CC



AD2523 ALUMINUM WASHER
(20),3mm

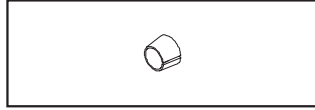

AD2555 FLYWHEEL COLLET
,5mm

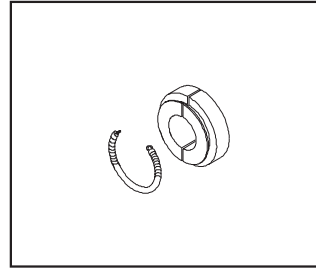

PD0140 CLUTCH SHOE SET

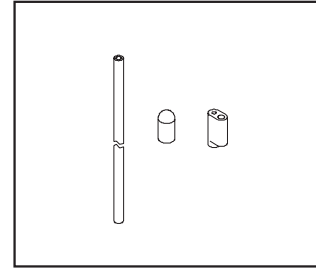

PD0225 ANTENNA BAG

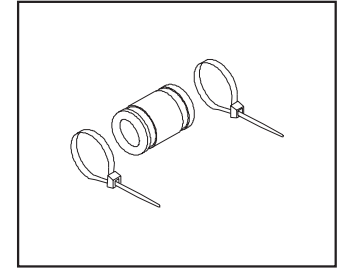

PD0871 TUNE PIPE COUPLER
,1/10

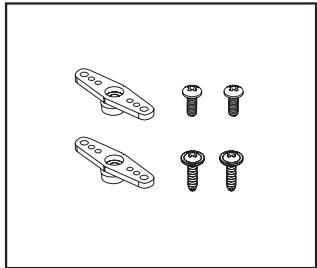

PD1526 SERVO HORNS,MTA4

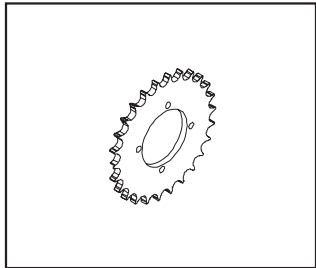

PD6054 RR CHAIN SPUR,FM1

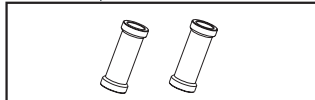

PD6050-T STEERING MOUNT
COLLARS, T1

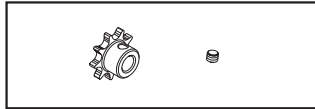

PD6055 FR CHAIN SPUR, FM1

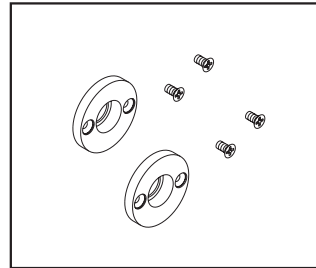

PD6057-T DRIVE AXLE MOUNT
,TI,FM1n

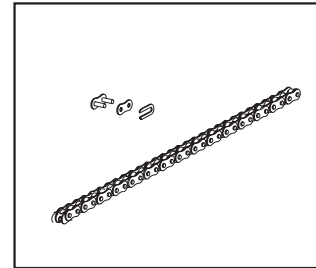

PD6062 DRIVE CHAIN, FM1

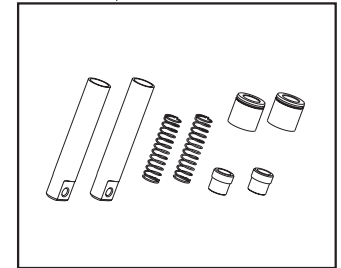

PD6276-T FR SHOCK BODY SET
,T1,FM1n

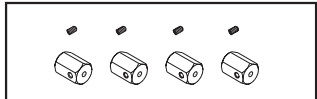

PD6280 SIDE GUARDS MOUNT
,FM1

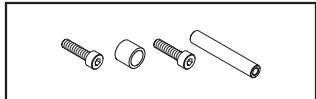

PD6284 FR AXLE SET ,FM1

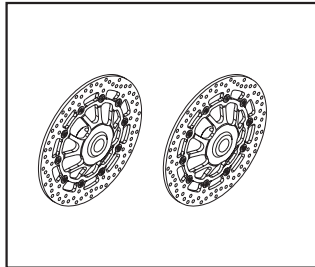

PD6285 FR BRAKE DISK
, DUCATI

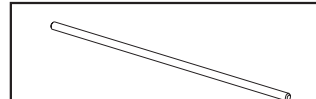

PD6296 HANDLE BAR, FM1

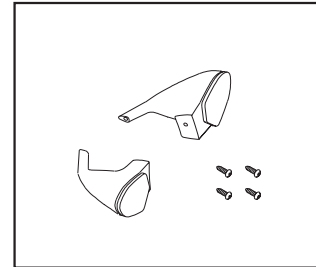

PD6301 BACK MIRROR
,DUCATI

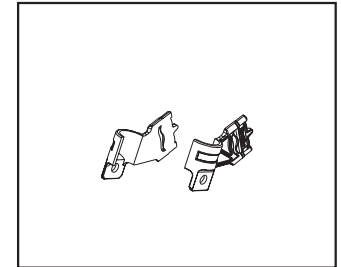

PD6302 FR BRAKE HOLDER
,DUCATI

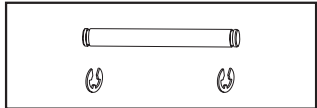

PD6282 STEERING SHAFT SET
,FM1

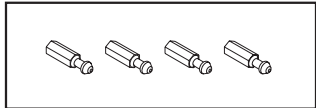

PD6293 BODY POSTS, FM1

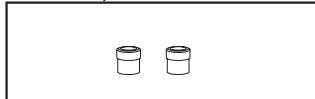

PD6407 SHOCK BODY SLEEVE
,FM1

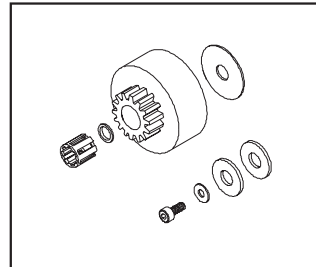

PD6415 CLUTCH BELL SET
,11T

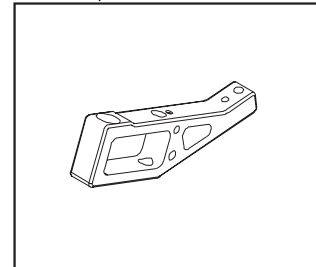

PD6530-T STEERING PIVOT
,TI,FM1n

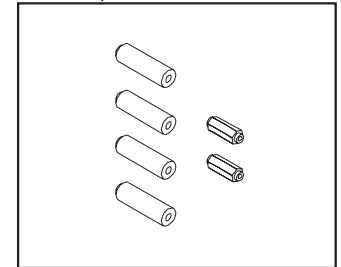

PD6531 FR FRAME POST SET
,FM1n

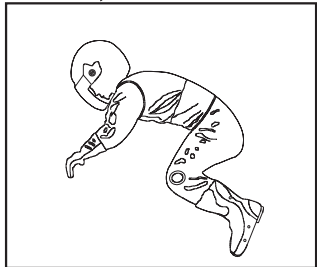

PD6303 RIDER ,DUCATI

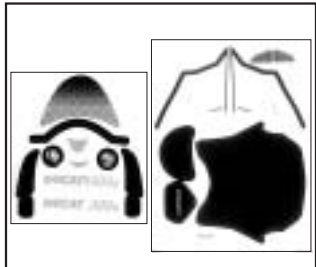

PD6304 DECAL ,DUCATI

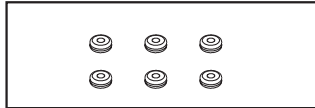

PD6424 BODY MOUNT
RUBBER SET, FM1

DUCATI 999R PARTS LIST

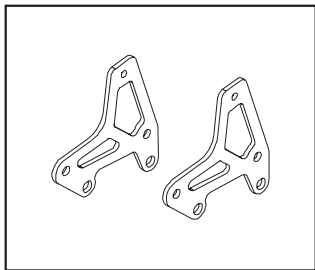

PD6532-T FRONT FRAME
,FM1n,TI

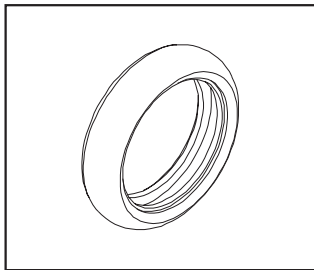

PD6533 FRONT SLICK TIRES
,FM1n

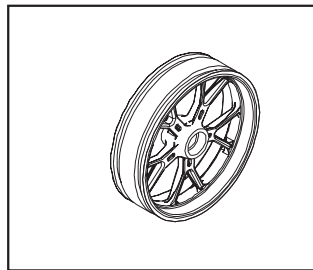

PD6534 FRONT WHEEL,
FM1n TI

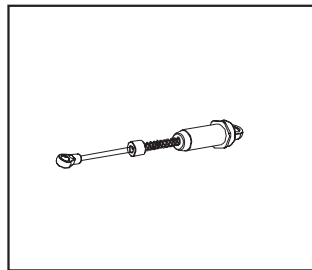

PD6535 STEERING DAMPER
SET,FM1n

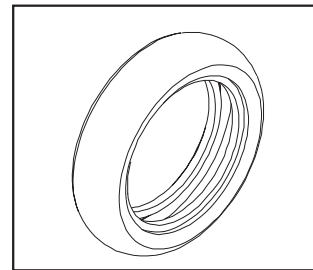

PD6536 RR SLICK TIRE,FM1n

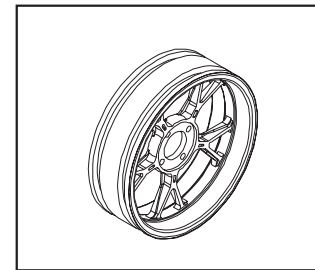

PD6537 RR WHEEL,FM1n

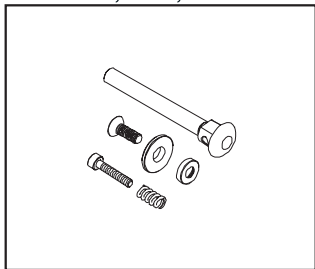

PD6538 REAR AXLE SET
,FM1n

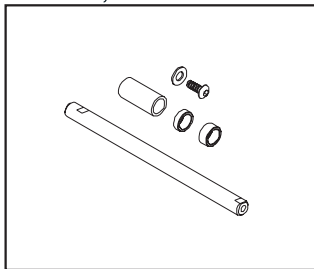

PD6539 RR DRIVE SHAFT
,FM1n

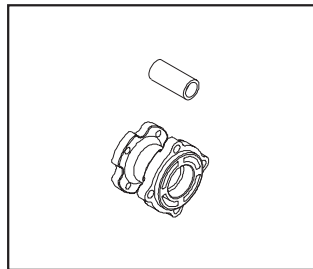

PD6540 RR HUB,FM1n

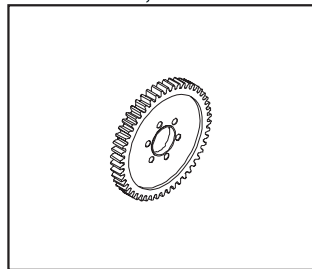

PD6541 MAIN GEAR SET,FM1n

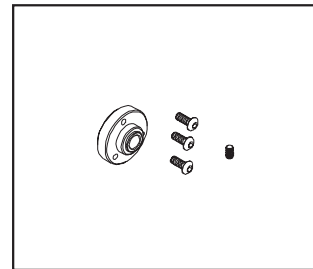

PD6542 MAIN GEAR ADAPTOR
,FM1n

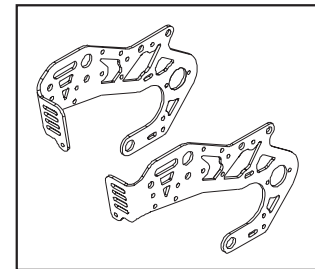

PD6543-T MAIN FRAME SET
,TI, FM1n

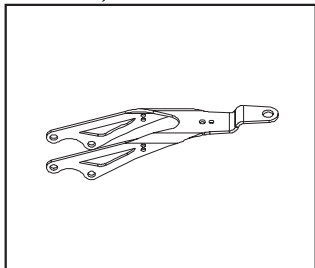

PD6544-T RR BRACKET,TI
,FM1n

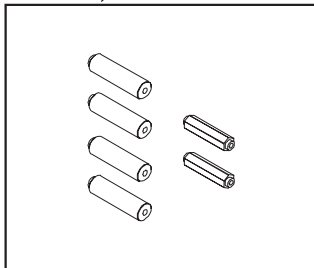

PD6545 RR FRAME POST SET
,FM1n

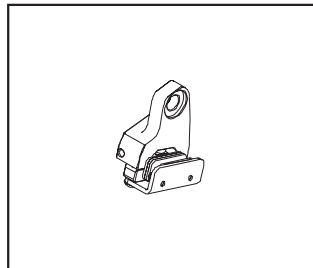

PD6546 RR DISK BRAKE SET
,FM1n

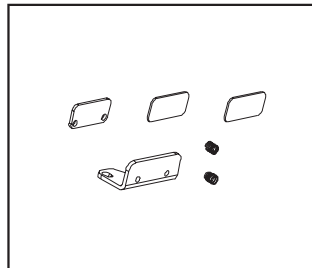

PD6547 FR BRAKE PAD SET
,FM1n

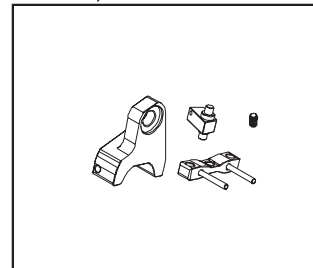

PD6548 FR BRAKE MOUNT
,FM1n

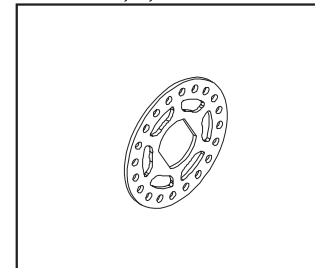

PD6550 RR VENTED BRAKE
DISK,FM1n

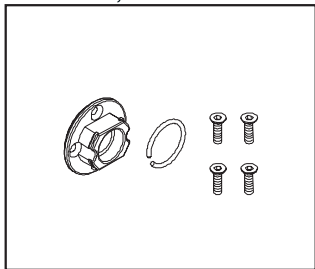

PD6551 BRAKE DISK HOLDER
,FM1n

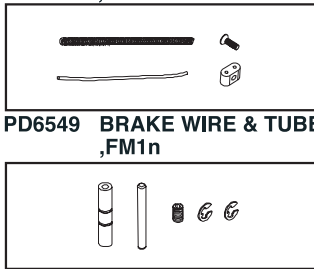

PD6549 BRAKE WIRE & TUBE
,FM1n

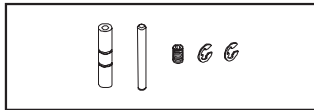

PD6552 RR SHOCK FIXING
SHAFT, FM1n

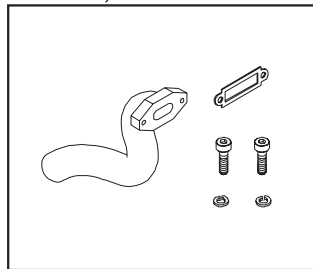

PD6553 EXHAUST HEADER
,FM1n

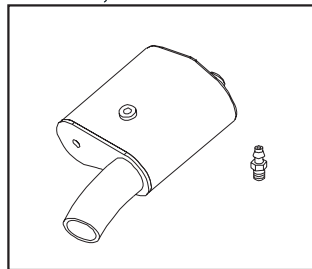

PD6554 MUFFLER, FM1n

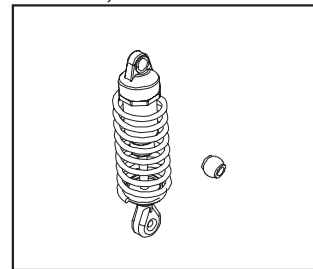

PD6555 RR SHOCK SET,FM1n

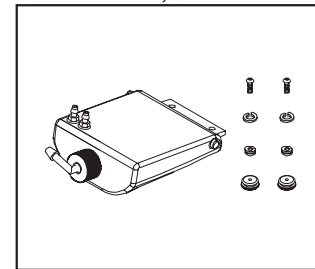

PD6556 FUEL TANK SET,FM1n

DUCATI 999R PARTS LIST

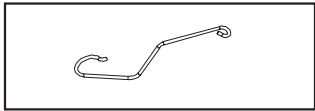

PD6557 FUEL TANK SUPPORT
,FM1n



PD6560 STEERING HARDWARE
,FM1n

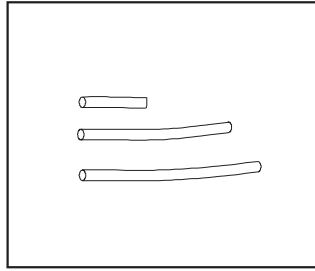

PD6558 FUEL TUBE,FM1n

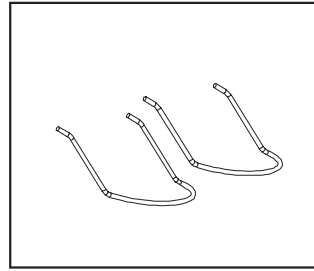

PD6559 SIDE GUARD WIRE
,FM1n

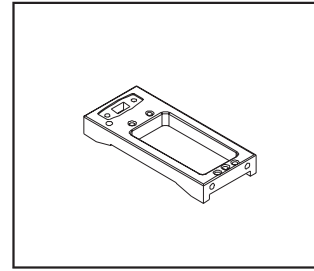

PD6561 SERVO TRAY,FM1n

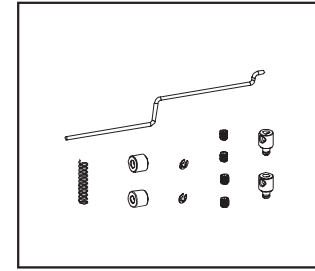

PD6562 THROTTLE LINKAGE
,FM1n

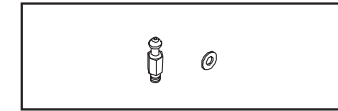

PD6563 RR METAL BODY POST
,FM1n



PD6565 AIR FILTER SET,FM1n

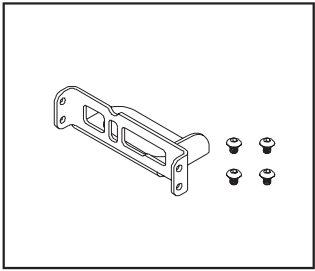

PD6564 BATTERY BRACKET
,FM1n

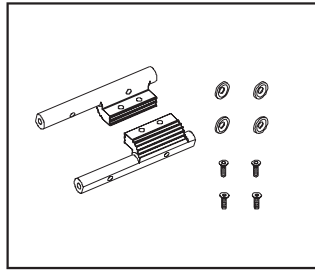

PD6566 ENGINE MOUNT,FM1n

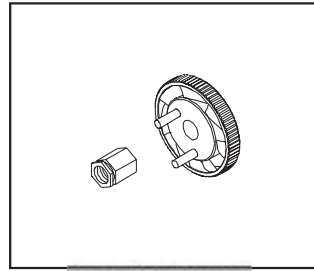

PD6567 FLYWHEEL,FM1n

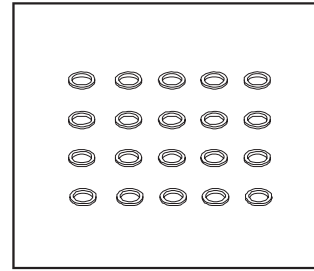

PD6568 WASHER(20),5mm

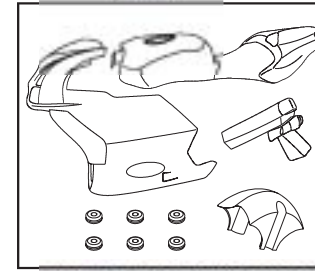

PD6569 PAINTED BODY,DUCATI 999R
PD6570 CLEAR BODY,DUCATI 999R

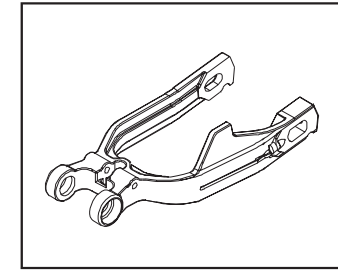

PD6571 RR SWING ARM,FM1n

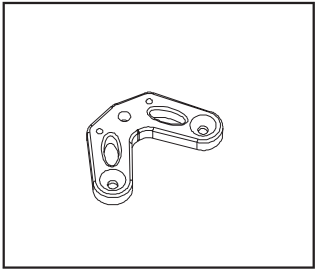

PD6572-T UPPER ALUM ST.
MOUNT, TI, FM1n

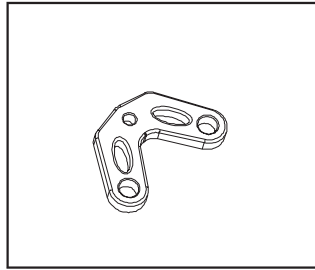

PD6573-T LOWER ALUM ST.
MOUNT, TI, FM1n



PD6574 GLOW PLUG EXTEND
WIRE

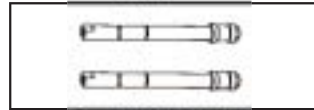

PD6575 FRONT SHOCK SHAFT
,FM1

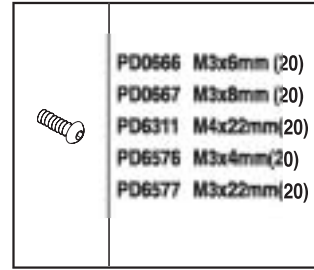

BT H.M. SCREW

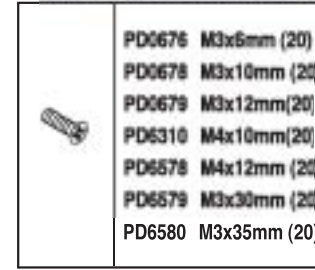

CT H.M. SCREW

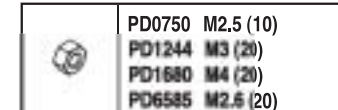

LOCK NUT

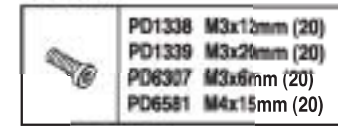

SK H.M. SCREW

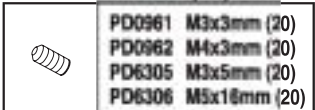

SET SCREW

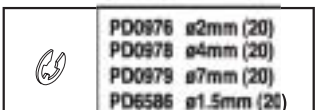

E-CLIP

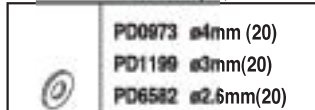

WASHER

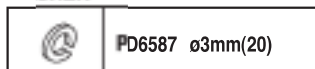

SPRING WASHER

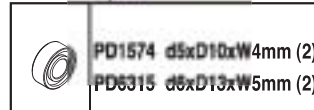

BEARING

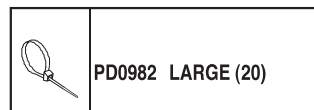

ZIP-TIE

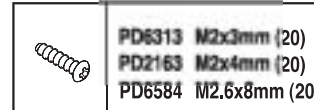

BT P.T. SCREW

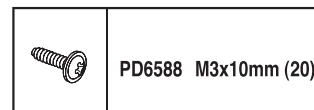

BT P.T. SCREW W/W

- PD0566 M3x6mm (20)
- PD0567 M3x8mm (20)
- PD6311 M4x22mm(20)
- PD6576 M3x4mm(20)
- PD6577 M3x22mm(20)

- PD0676 M3x6mm (20)
- PD0678 M3x10mm (20)
- PD0679 M3x12mm(20)
- PD6310 M4x10mm(20)
- PD6578 M4x12mm (20)
- PD6579 M3x30mm (20)
- PD6580 M3x35mm (20)

- PD0750 M2.5 (10)
- PD1244 M3 (20)
- PD1680 M4 (20)
- PD6585 M2.6 (20)

- PD1338 M3x12mm (20)
- PD1339 M3x20mm (20)
- PD6307 M3x6mm (20)
- PD6581 M4x15mm (20)



1/5 DUCATI 999R R/C SC MOTORBIKE PARTS LIST

PART#	DESCRIPTION	NOTE
8114	SERVO	
1104	FUEL BOTTLE,100CC	
AD2523	ALUMINUM WASHER(20),3mm	
AD2555	FLYWHEEL COLLET,5mm	
PD0140	CLUTCH SHOE SET	
PD0225	ANTENNA BAG	
PD0666	BT H.M SCREW (20), M3X6	
PD0667	BT H.M SCREW (20), M3X8	
PD0676	CT H.M SCREW(20), M3x6	
PD0678	E-CLIP(20),4mm	
PD0679	E-CLIP(20),7mm	
PD0750	LOCK NUT(10),M2.5	
PD0871	TUNE PIPE COUPLER,1/10	
PD0961	SET SCREW(20),M3x3	
PD0962	SET SCREWS(20),M4x3	
PD0973	WASHER(20),4mm	
PD0976	E-CLIP(20),2MM	
PD0978	E-CLIP(20),5MM	
PD0979	E-CLIP(20),7mm	
PD0982	LARGE NYLON STRAP,LARGE	
PD1199	WASHER(20),3mm	
PD1244	LOCK NUT(10),M3	
PD1338	SK H.M SCREW (20),M3x12	
PD1339	SK H.M SCREW (20),M3x20	
PD1526	SERVO HORNS,MTA4	
PD1574	BALL BEARING(2),d5xD10xW4	
PD1680	LOCK NUT(20),M4	
PD1715	START SHAFT	
PD2163	BHP SCREW(20),M2x4	
PD6050-T	STEERING PIVOT POST, TI	
PD6054	RR CHAIN SPUR,FM1	
PD6055	FR CHAIN SPUR,FM1	
PD6057-T	DRIVE AXLE MOUNT,TI ,FM1n	
PD6062	DRIVE CHAIN,FM	
PD6276-T	FR SHOCK BODY SET,TI ,FM1n	
PD6280	SIDE GUARDS MOUNT,FM1	
PD6282	STEERING SHAFT SET,FM1	
PD6284	FR AXLE SET,FM1	
PD6285	FR BRAKE DISK,DUCATI	
PD6293	BODY POSTS, FM1	

PART#	DESCRIPTION	NOTE
PD6296	HANDLE BAR,FM1E	
PD6297	FR BODY POST,FM1	
PD6301	BACK MIRROR,DUCATI	
PD6302	FR BRAKE HOLDER,DUCATI	
PD6303	RIDER,DUCATI	
PD6304	DECAL,DUCATI	
PD6305	SET SCREW(20),M3x5	
PD6306	SET SCREW(20),M5x16	
PD6307	SK H.M SCREW (20),M3x6	
PD6310	CT H.M SCREW, M4x10	
PD6311	BT H.M SCREW (20),M4x22	
PD6313	BT P.T SCREW(20), M2x3	
PD6315	BALL BEARING(2),d6xD13xW5	
PD6407	SHOCK BODY SLEEVE,FM1	
PD6415	CLUTCH BELL SET,11T	
PD6424	BODY MOUNT RUBBER SET,FM1	
PD6530-T	STEERING PIVOT ,TI ,FM1n	
PD6531	FR FRAME POST SET,FM1n	
PD6532-T	FRONT FRAME,FM1n,TI	
PD6533	FRONT SLICK TIRES,FM1n	
PD6534	FRONT WHEEL,FM1n TI	
PD6535	STEERING DAMPER SET,FM1n	
PD6536	RR SLICK TIRE,FM1n	
PD6537	RR WHEEL,FM1n	
PD6538	REAR AXLE SET,FM1n	
PD6539	RR DRIVE SHAFT,FM1n	
PD6540	RR HUB,FM1n	
PD6542	MAIN GEAR ADAPTOR,FM1n	
PD6543-T	MAIN FRAME SET,TI, FM1n	
PD6544-T	RR BRACKET,TI, FM1n	
PD6545	RR FRAME POST SET,FM1n	
PD6546	RR DISK BRAKE SET,FM1n	
PD6547	FR BRAKE PAD SET,FM1n	
PD6548	FR BRAKE MOUNT,FM1n	
PD6549	BRAKE WIRE & TUBE,FM1n	
PD6550	RR VENTED BRAKE DISK,FM1n	
PD6551	BRAKE DISK HOLDER,FM1n	
PD6552	RR SHOCK FIXING SHAFT, FM1n	
PD6553	EXHAUST HEADER,FM1n	
PD6554	MUFFLER, FM1n	

PART#	DESCRIPTION	NOTE
PD6555	RR SHOCK SET,FM1n	
PD6556	FUEL TANK SET,FM1n	
PD6557	FUEL TANK SUPPORT,FM1n	
PD6558	FUEL TUBE,FM1n	
PD6559	SIDE GUARD WIRE,FM1n	
PD6560	STEERING HARDWARE,FM1n	
PD6561	SERVO TRAY,FM1n	
PD6562	THROTTLE LINKAGE,FM1n	
PD6563	RR METAL BODY POST,FM1n	
PD6564	BATTERY BRACKET,FM1n	
PD6565	AIR FILTER SET,FM1n	
PD6566	ENGINE MOUNT,FM1n	
PD6567	FLYWHEEL,FM1n	
PD6568	WASHER(20),5mm	
PD6569	PAINTED BODY,DUCATI 999R	
PD6570	CLEAR BODY,DUCATI 999R	
PD6571	RR SWING ARM,FM1n	
PD6572-T	UPPER ALUM ST. MOUNT, TI, FM1n	
PD6573-T	LOWER ALUM ST. MOUNT,TI, FM1n	
PD6574	GLOW PLUG EXTEND WIRE	
PD6575	FRONT SHOCK SHAFT,FM1	
PD6576	BT H.M SCREW (20), M3x4	
PD6577	BT H.M SCREW (20), M3x22	
PD6578	CT H.M SCREW(20), M4x12	
PD6579	CT H.M SCREW(20), M3x30	
PD6580	CT H.M SCREW(20), M3x35	
PD6581	SK H.M SCREW(20),M4x15	
PD6582	WASHER(20),2.6mm	
PD6583	WASHER(20),5mm	
PD6584	BT P.T SCREW(20), M2.6x8	
PD6585	NUT(20),M2.6	
PD6586	E-CLIP(20),15mm	
PD6587	SPRING WASHER(20),3mm	
PD6588	BT P.T SCREW w/w(20), M3x10	
PD6596	METAL BIKE STAND	
PD6597	GLOW PLUG WRENCH ADAPTOR	



DUCATI 999R

TESTASTRETTA 1/5TH SCALE NITRO POWERED MOTORBIKE

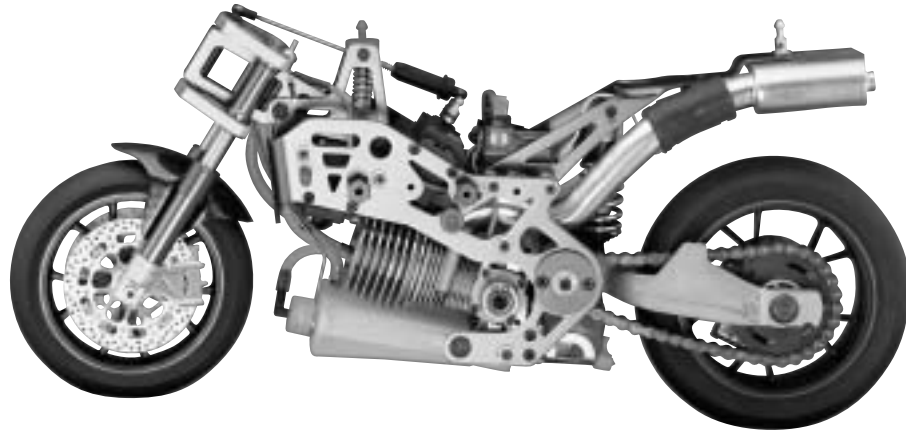

Feature:

- * 100% factory assembled and factory painted DUCATI 999R body shell (high impact) with realistic vinyl rider figure.
- * Powerful PRO-12BK engine with hex starter
- * Patent dual spring loaded and oil-filled steering damper
- * Aluminum spring loaded upside down front fork
- * Aluminum rear oil-filled adjustable mono shock
- * Aluminum rear disc brake system
- * Aluminum front and rear wheels w/ high grip slick tires
- * Aluminum side frame
- * Aluminum rear swing arm
- * Fully functional steel drive chain and sprocket w/ball bearing.
- * Circular, roll-over protection wire

Specifications:

- Length: 413.5mm(16.3in)
- Width: 116mm(4.6in)
- Height: 200mm(7.9in)
- Wheel Base: 295mm(11.6in)
- Front Wheel: 110mm(4.3in)
- Rear Wheel: 127mm(5.0in)
- Weight: 2200g(77.6oz)
w/Servo, Receiver, Engine
- Engine: PRO-12BK
- Radio: Jaguar 2CH

INCLUDED

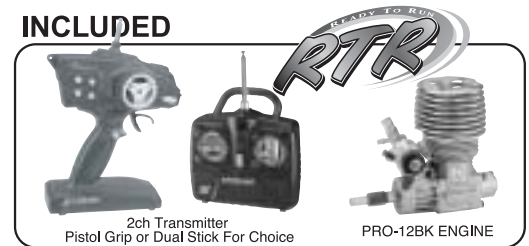

DUCATI 999R OPTIONAL PARTS LIST

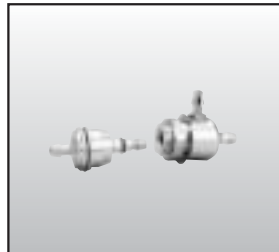

1115 FUELER VALVE

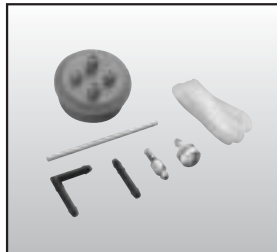

1203 SILICON CAP



1645 HAND CRANK FUEL PUMP



2674 12V H.D 90 STARTER
3801 6MM STARTER EXTENSION



2907AC/J-S 4.8V, 700mAh
Ni-Cd BATTERY

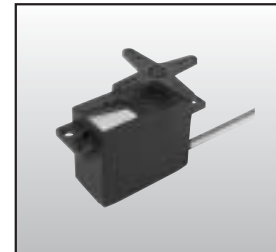

8118 HI TORQUE SERVO/
7.8kg-cm



AQ0579 MINI RECEIVER



PD6589-B ALUM 3 SPOKE WHEEL,
FR BLACK FM1n



PD6589-S ALUM 3 SPOKE WHEEL,
FR SILVER FM1n



PD6590-B ALUM 3 SPOKE WHEEL,
RR BLACK FM1n



PD6590-S ALUM 3 SPOKE WHEEL,
RR SILVER FM1n

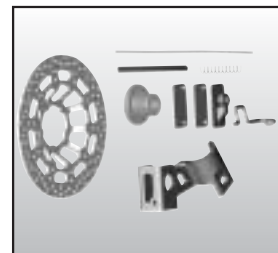

PD6591 FRONT DISK
BRAKE SET,FM1n

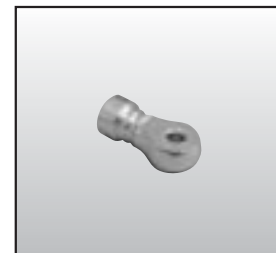

PD6592 ALUM SHOCK
BOTTOM

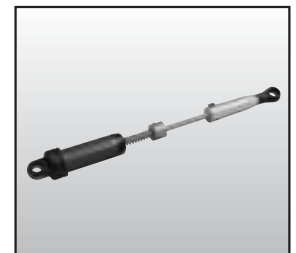

PD6593 ALUM STEERING
DAMPER SET